

| | | | |
|------------|------------|-------|----|
| 1: 9.8 ↓ | 6: 10.2 ↖ | Serie | 99 |
| 2: 10.0 ↓ | 7: 10.3 ↗ | | |
| 3: 10.3 ↓ | 8: 10.5x ↗ | Total | 0 |
| 4: 10.3 ↗ | 9: 10.4 → | | |
| 5: 10.6x ↘ | 10: 10.3 ↗ | | |

| | | |
|-------------|-------|----|
| 11: 10.5x ↖ | Serie | 20 |
| 12: 10.5 ↑ | | |
| Total | | 0 |

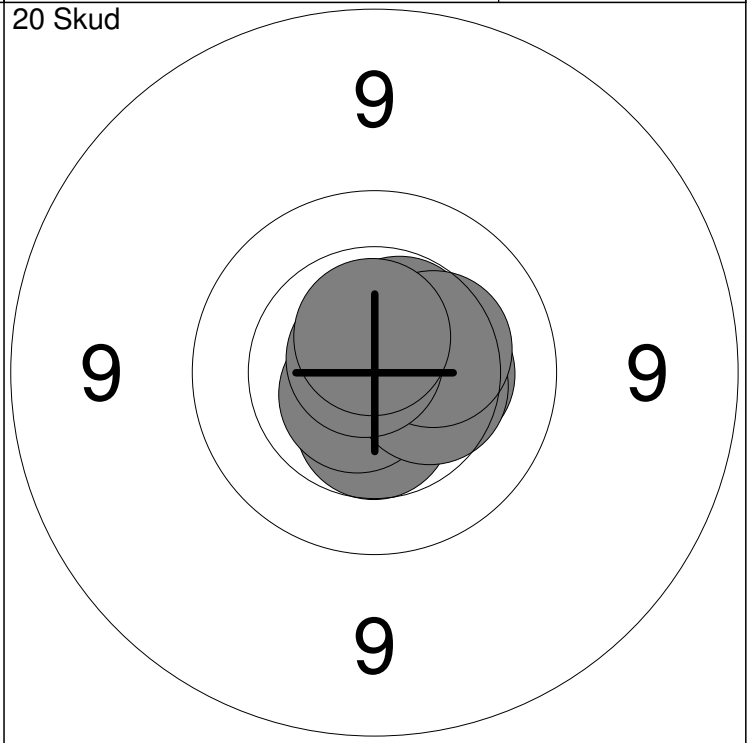
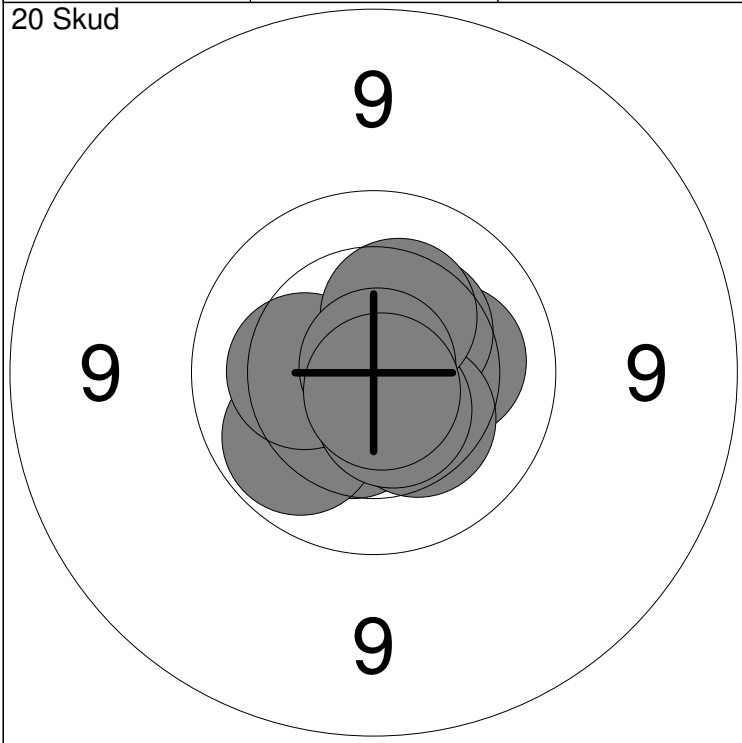

| | | | |
|-----------|-------------|-------|-----|
| 1: 10.2 → | 6: 10.3 ← | Serie | 100 |
| 2: 10.4 ↗ | 7: 10.5x ↓ | | |
| 3: 10.4 ↓ | 8: 10.4 ↗ | Total | 100 |
| 4: 10.3 ↓ | 9: 10.9x ↗ | | |
| 5: 10.0 ↙ | 10: 10.8x ↓ | | |

| | | | |
|-------------|-------------|-------|-----|
| 11: 10.5x ↗ | 16: 10.8x ↑ | Serie | 100 |
| 12: 10.5 ↓ | 17: 10.4 → | | |
| 13: 10.7x ↙ | 18: 10.3 ↗ | Total | 200 |
| 14: 10.3 → | 19: 10.8x ↖ | | |
| 15: 10.6x ↗ | 20: 10.6x ↑ | | |

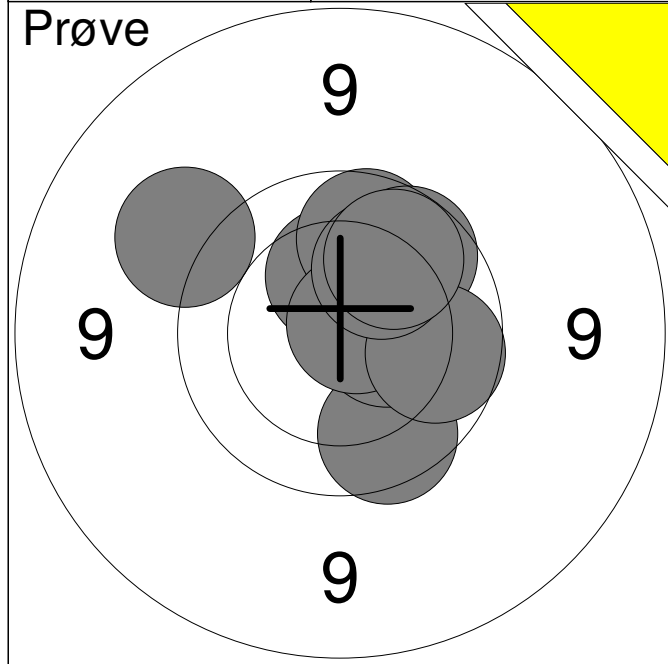

| | | |
|-----|-------|---|
| 1: | 9.8 | ↓ |
| 2: | 10.3 | ↑ |
| 3: | 9.9 | ↑ |
| 4: | 9.9 | ↗ |
| 5: | 10.4 | → |
| 6: | 10.7x | ↗ |
| 7: | 9.9 | → |
| 8: | 10.1 | ↗ |
| 9: | 9.4 | ↗ |
| 10: | 10.0 | ↗ |

| | |
|-------|------|
| Serie | 95.0 |
|-------|------|

| | |
|-------|-----|
| Total | 0.0 |
|-------|-----|

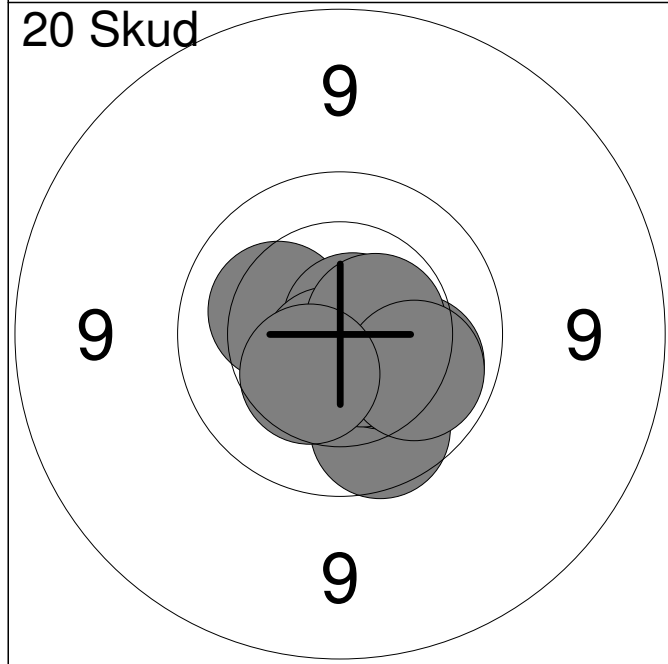

| | | |
|-----|-------|---|
| 1: | 10.2 | ↖ |
| 2: | 10.8x | ↗ |
| 3: | 10.7x | ↓ |
| 4: | 10.1 | → |
| 5: | 9.9 | ↓ |
| 6: | 10.4 | ↓ |
| 7: | 10.6x | ↓ |
| 8: | 10.5x | → |
| 9: | 10.1 | ↘ |
| 10: | 10.4 | ↘ |

| | |
|-------|------|
| Serie | 99.0 |
|-------|------|

| | |
|-------|------|
| Total | 99.0 |
|-------|------|

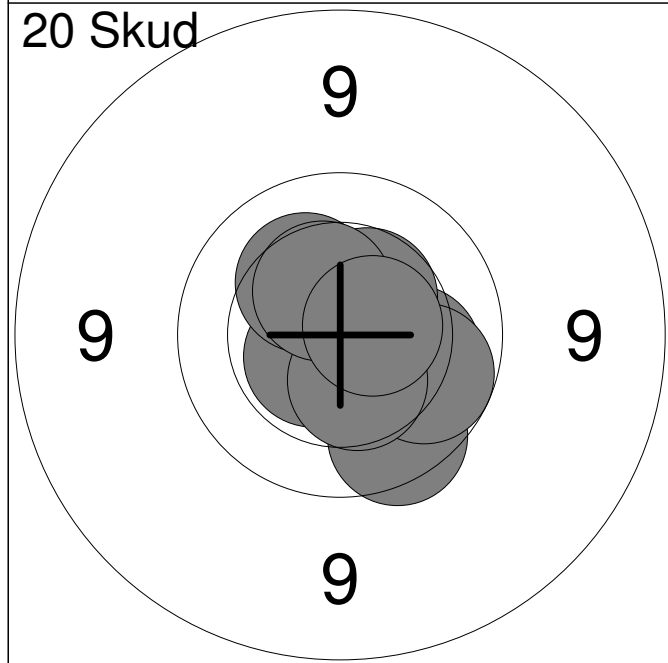

| | | |
|-----|-------|---|
| 11: | 10.9x | ↓ |
| 12: | 10.6x | ↖ |
| 13: | 10.2 | → |
| 14: | 10.3 | ↗ |
| 15: | 9.8 | ↓ |
| 16: | 10.5 | ↗ |
| 17: | 10.0 | → |
| 18: | 10.4 | ↓ |
| 19: | 10.4 | ↗ |
| 20: | 10.6x | → |

| | |
|-------|------|
| Serie | 99.0 |
|-------|------|

| | |
|-------|-------|
| Total | 198.0 |
|-------|-------|

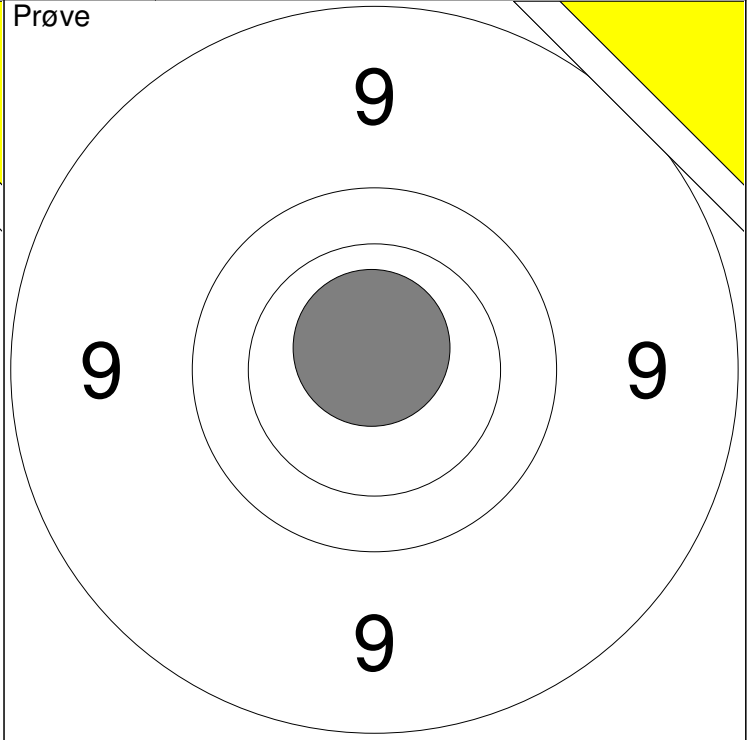
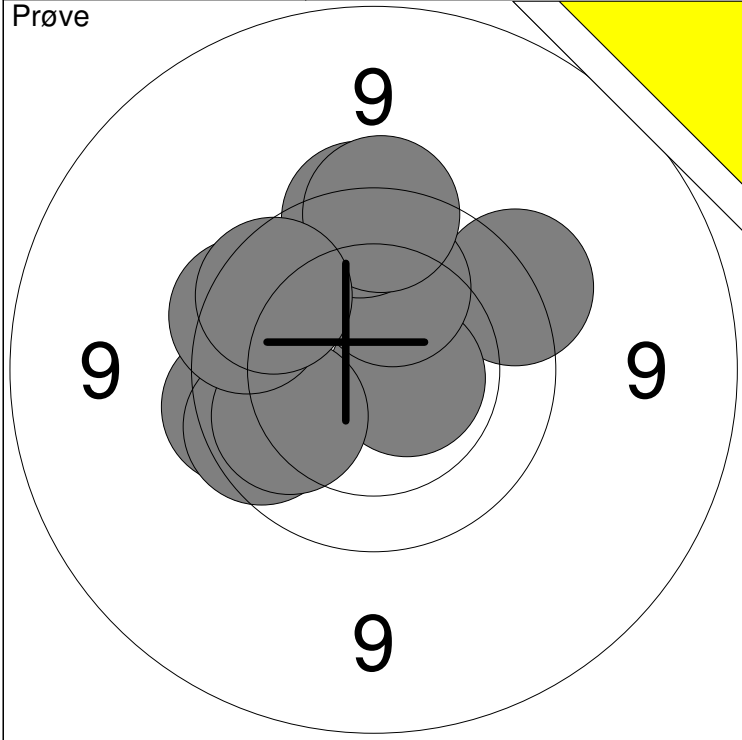

| | | | |
|------------|-----------|-------|----|
| 1: 9.8 ← | 6: 9.7 ↑ | Serie | 93 |
| 2: 9.6 ↗ | 7: 10.0 ↙ | | |
| 3: 10.6x → | 8: 9.8 ← | Total | 0 |
| 4: 10.1 ↑ | 9: 9.7 ↑ | | |
| 5: 9.8 ← | 10: 9.8 ↙ | | |

| | | | |
|-------------|--|-------|----|
| 11: 10.7x ↑ | | Serie | 10 |
| | | | |
| | | Total | 0 |
| | | | |

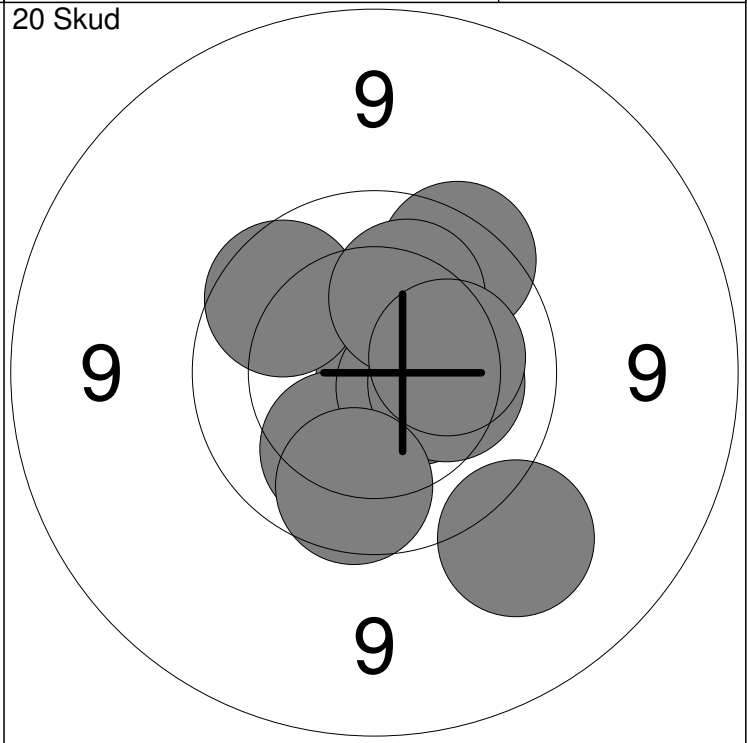
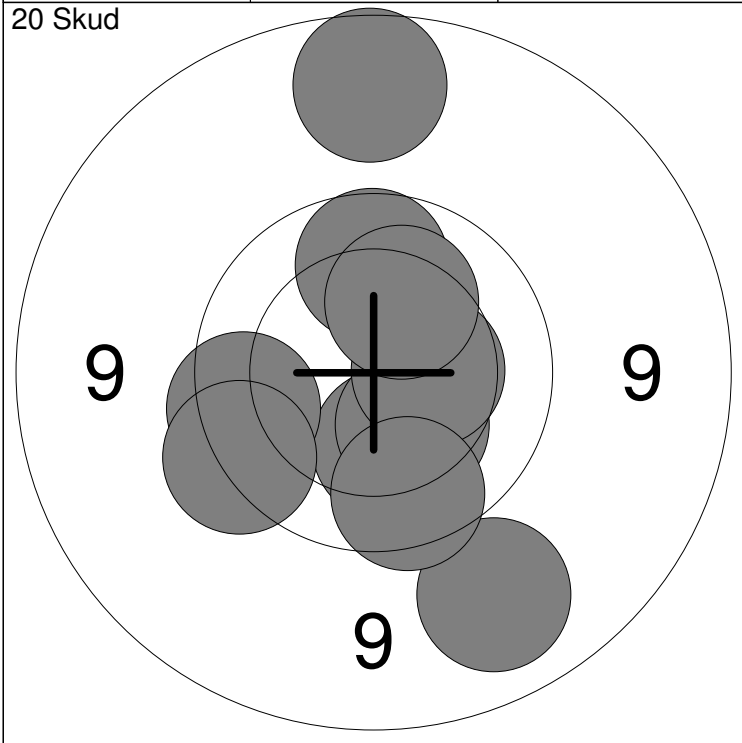

| | | | |
|-----------|------------|-------|----|
| 1: 10.2 ↓ | 6: 8.9 ↑ | Serie | 93 |
| 2: 9.8 ← | 7: 10.4 → | | |
| 3: 10.3 ↓ | 8: 9.8 ↓ | Total | 93 |
| 4: 9.1 ↓ | 9: 9.9 ↑ | | |
| 5: 9.6 ← | 10: 10.2 ↑ | | |

| | | | |
|-------------|------------|-------|-----|
| 11: 10.7x → | 16: 10.2 → | Serie | 96 |
| 12: 10.1 ↓ | 17: 9.9 ↗ | | |
| 13: 9.8 ↗ | 18: 9.9 ↓ | Total | 189 |
| 14: 9.3 ↓ | 19: 10.2 ↑ | | |
| 15: 10.5x → | 20: 10.2 → | | |

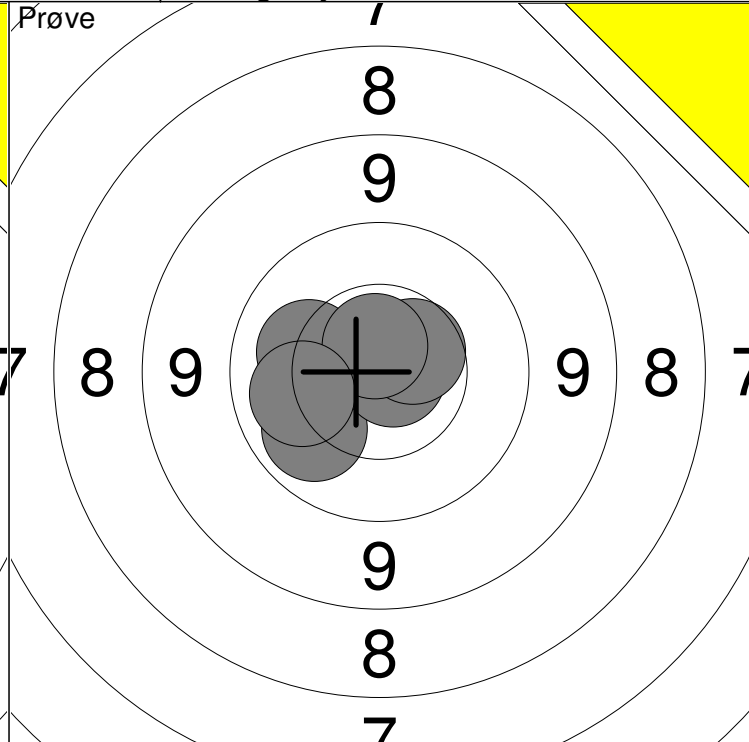
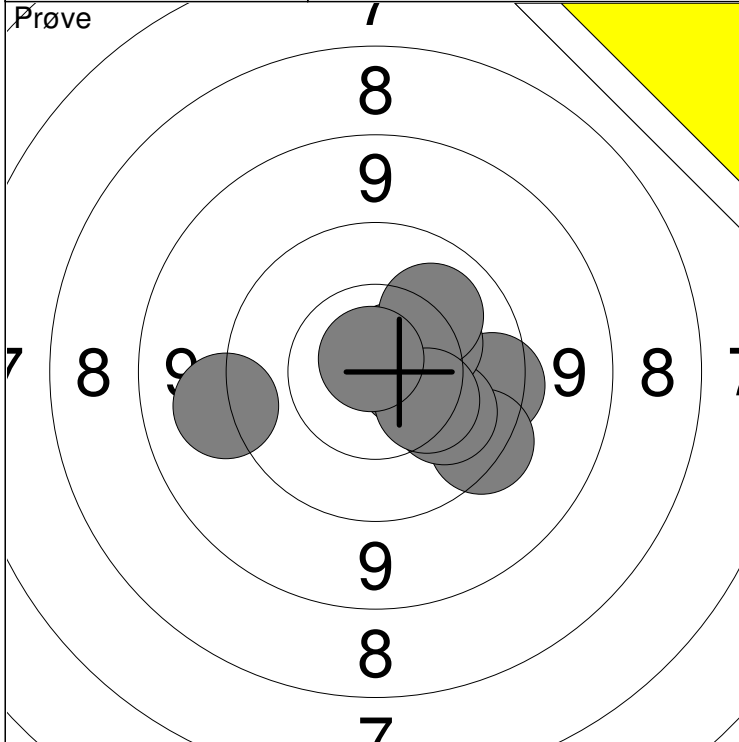

| | | | |
|------------|-------------|-------|----|
| 1: 9.7 → | 6: 10.3 ↗ | Serie | 97 |
| 2: 10.7x ↗ | 7: 10.1 ↗ | | |
| 3: 10.6x → | 8: 10.3 ↘ | Total | 0 |
| 4: 9.6 ↘ | 9: 9.3 ← | | |
| 5: 10.1 ↘ | 10: 10.8x ↗ | | |

| | | | |
|-------------|-------------|-------|----|
| 11: 10.1 ↖ | 16: 10.1 ← | Serie | 60 |
| 12: 10.8x → | 13: 10.2 ↖ | | |
| 14: 10.5 ↗ | 15: 10.7x ↗ | Total | 0 |
| | | | |

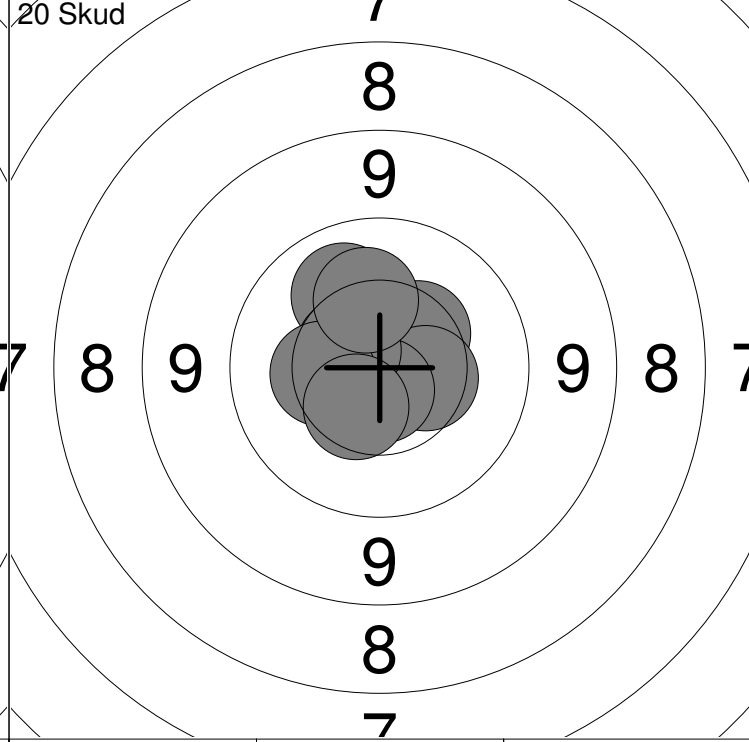
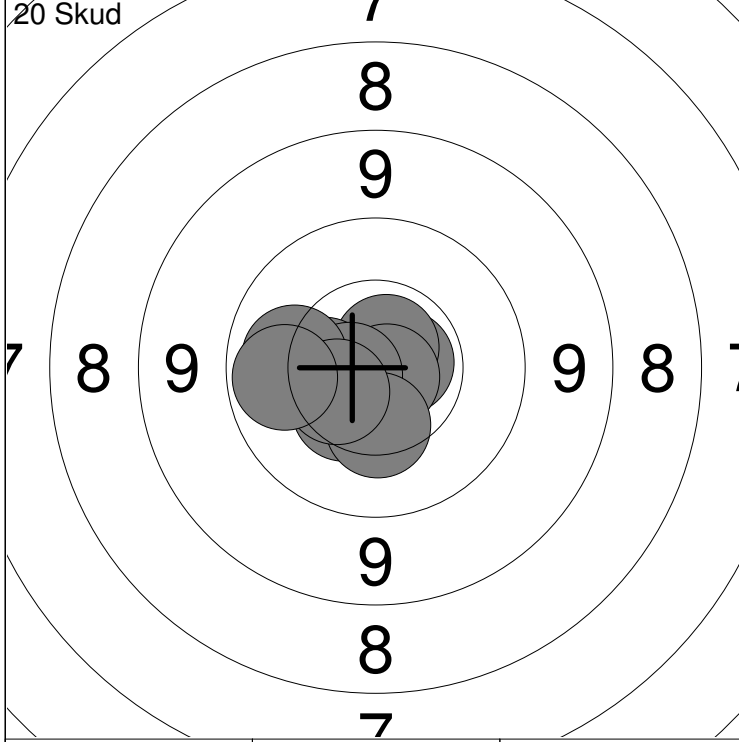

| | | | |
|------------|------------|-------|-----|
| 1: 10.7x → | 6: 10.7x ← | Serie | 100 |
| 2: 10.7x ↗ | 7: 10.4 ↓ | | |
| 3: 10.4 ↖ | 8: 10.1 ← | Total | 100 |
| 4: 10.8x ↘ | 9: 10.5 ← | | |
| 5: 10.4 ← | 10: 10.0 ← | | |

| | | | |
|-------------|-------------|-------|-----|
| 11: 10.4 ↗ | 16: 10.7x ↓ | Serie | 100 |
| 12: 10.8x ↘ | 17: 10.6 ↖ | | |
| 13: 10.5 → | 18: 10.4 ← | Total | 200 |
| 14: 10.6x ↖ | 19: 10.5 ↘ | | |
| 15: 10.1 ↗ | 20: 10.2 ↗ | | |

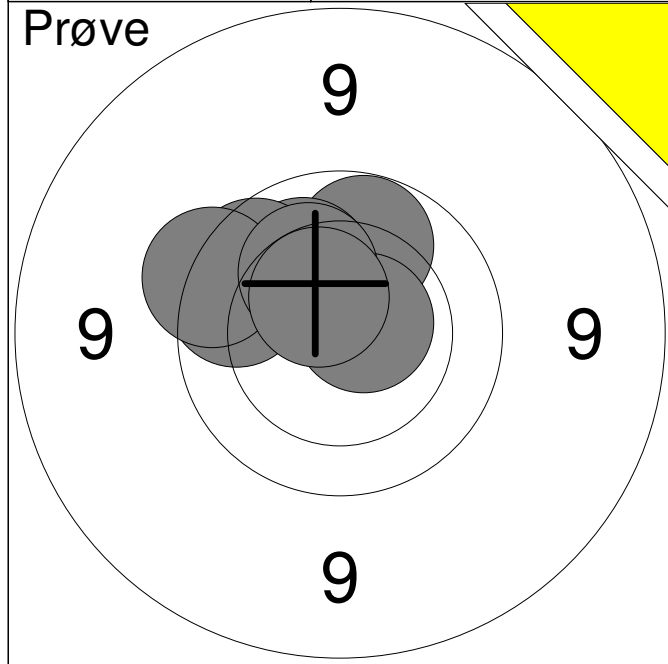

| | | |
|--------------|-------|-------------|
| 1: | 10.0 | ↑ |
| 2: | 10.1 | ↗ |
| 3: | 9.9 | ↗ |
| 4: | 9.8 | ↗ |
| 5: | 9.7 | ↗ |
| 6: | 10.7x | → |
| 7: | 10.2 | ↗ |
| 8: | 10.5x | ↗ |
| Serie | | 77.0 |
| Total | | 0.0 |

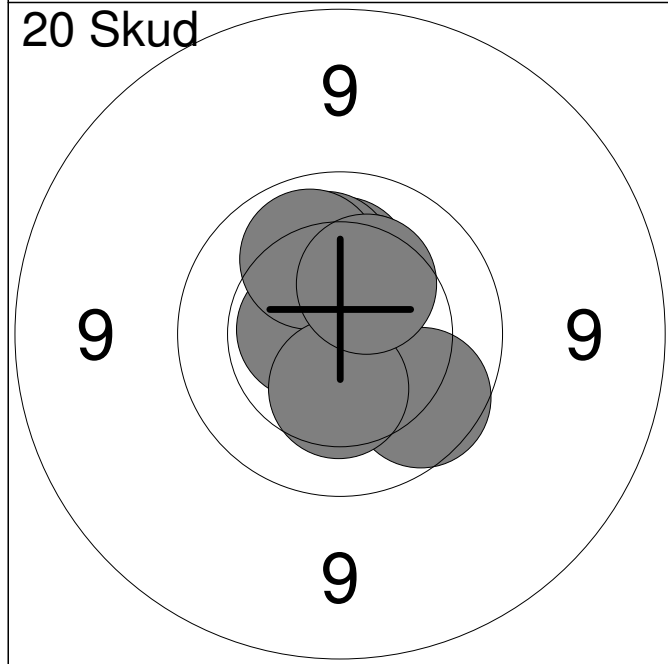

| | | |
|--------------|-------|-------------|
| 1: | 10.5x | ↑ |
| 2: | 10.2 | ↑ |
| 3: | 10.4 | ↗ |
| 4: | 9.9 | ↘ |
| 5: | 10.6x | ↗ |
| 6: | 10.1 | ↑ |
| 7: | 10.6x | ← |
| 8: | 10.1 | ↗ |
| 9: | 10.4 | ↓ |
| 10: | 10.3 | ↗ |
| Serie | | 99.0 |
| Total | | 99.0 |

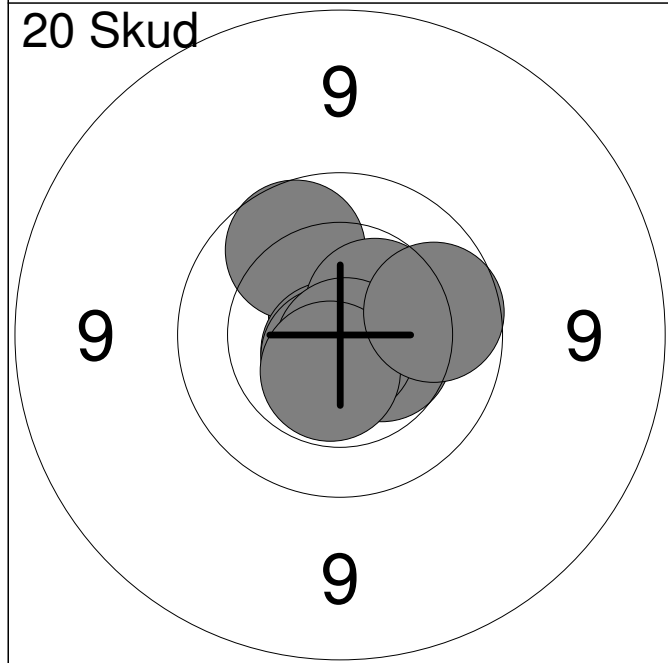

| | | |
|--------------|-------|--------------|
| 11: | 10.7x | ↗ |
| 12: | 10.7x | ↑ |
| 13: | 9.9 | ↗ |
| 14: | 10.7x | ↘ |
| 15: | 10.7x | ↘ |
| 16: | 10.5 | → |
| 17: | 10.5 | ↗ |
| 18: | 10.8x | ↓ |
| 19: | 10.5x | ↓ |
| 20: | 9.9 | → |
| Serie | | 98.0 |
| Total | | 197.0 |

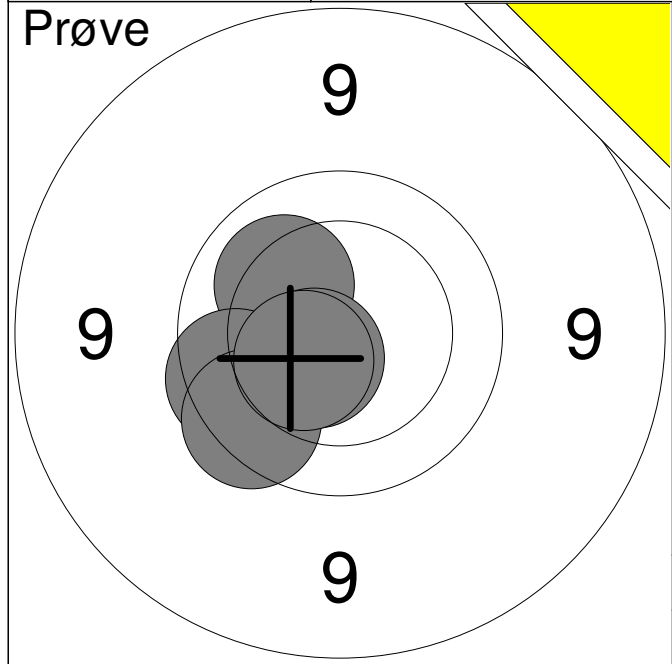

| | | |
|--------------|-------|-------------|
| 1: | 10.2 | ↗ |
| 2: | 9.8 | ↖ |
| 3: | 9.8 | ↖ |
| 4: | 10.6x | ↖ |
| 5: | 10.5 | ↖ |
| Serie | | 48.0 |
| Total | | 0.0 |

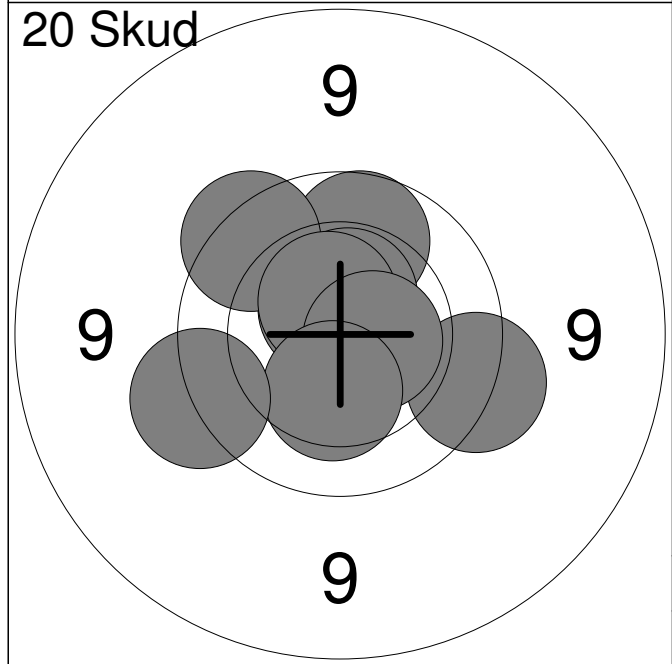

| | | |
|--------------|-------|-------------|
| 1: | 9.9 | ↑ |
| 2: | 10.6x | ↑ |
| 3: | 9.6 | → |
| 4: | 9.7 | ↗ |
| 5: | 10.5x | ↑ |
| 6: | 10.8x | ↗ |
| 7: | 10.6x | ↑ |
| 8: | 10.6x | → |
| 9: | 10.3 | ↓ |
| 10: | 9.6 | ↖ |
| Serie | | 96.0 |
| Total | | 96.0 |

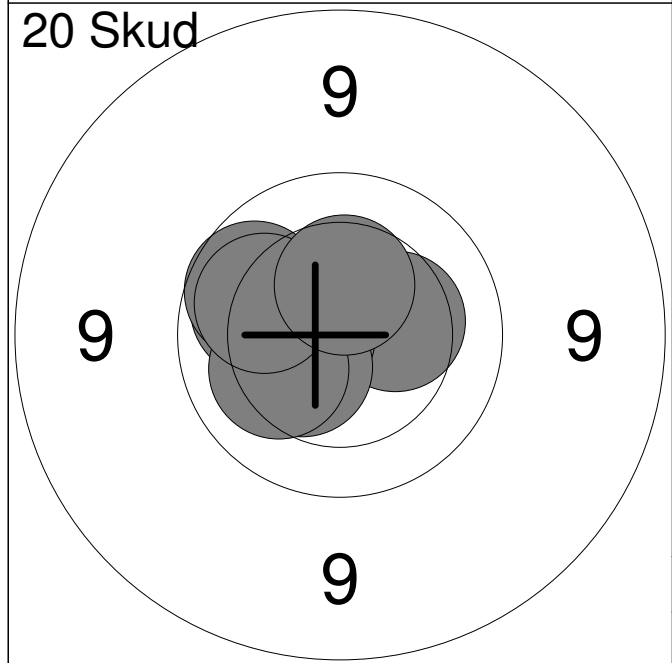

| | | |
|--------------|-------|--------------|
| 11: | 10.8x | ↗ |
| 12: | 10.3 | → |
| 13: | 10.0 | ↖ |
| 14: | 10.6x | ↖ |
| 15: | 10.4 | ↗ |
| 16: | 10.4 | ↖ |
| 17: | 10.2 | ↖ |
| 18: | 9.9 | ↗ |
| 19: | 10.1 | ↗ |
| 20: | 10.4 | ↑ |
| Serie | | 99.0 |
| Total | | 195.0 |

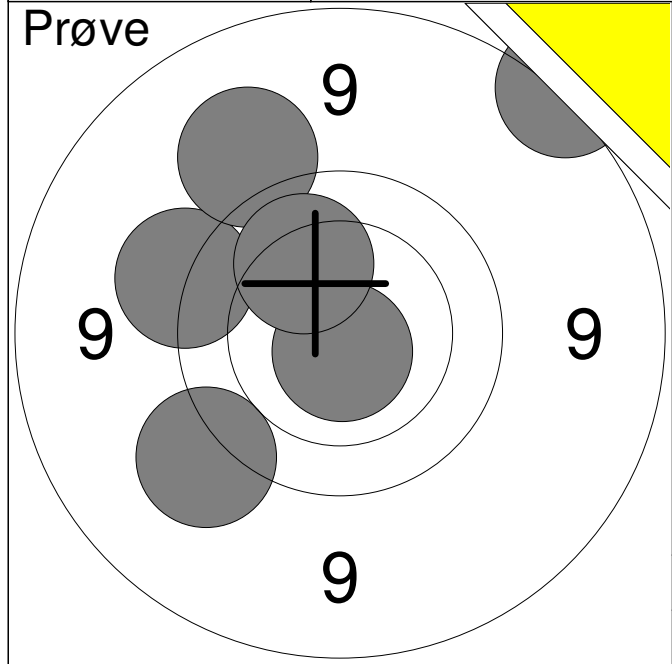

| | | |
|--------------|-------|-------------|
| 1: | 9.5 | ← |
| 2: | 8.6 | ↗ |
| 3: | 10.8x | ↓ |
| 4: | 9.3 | ↗ |
| 5: | 9.4 | ↖ |
| 6: | 10.1 | ↗ |
| Serie | | 55.0 |
| Total | | 0.0 |

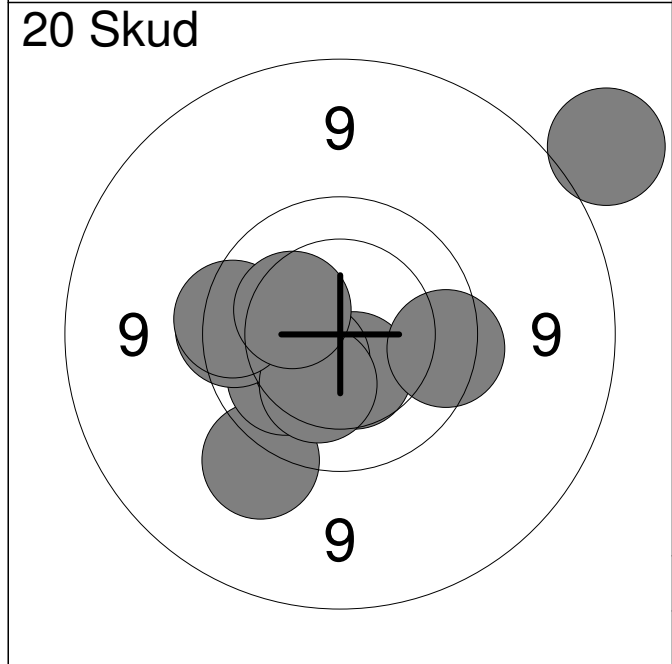

| | | |
|--------------|------|-------------|
| 1: | 10.5 | ↓ |
| 2: | 9.4 | ↘ |
| 3: | 9.7 | → |
| 4: | 10.1 | ↖ |
| 5: | 10.5 | ↖ |
| 6: | 9.7 | ← |
| 7: | 8.4 | ↗ |
| 8: | 10.3 | ↓ |
| 9: | 9.7 | ← |
| 10: | 10.3 | ↗ |
| Serie | | 94.0 |
| Total | | 94.0 |

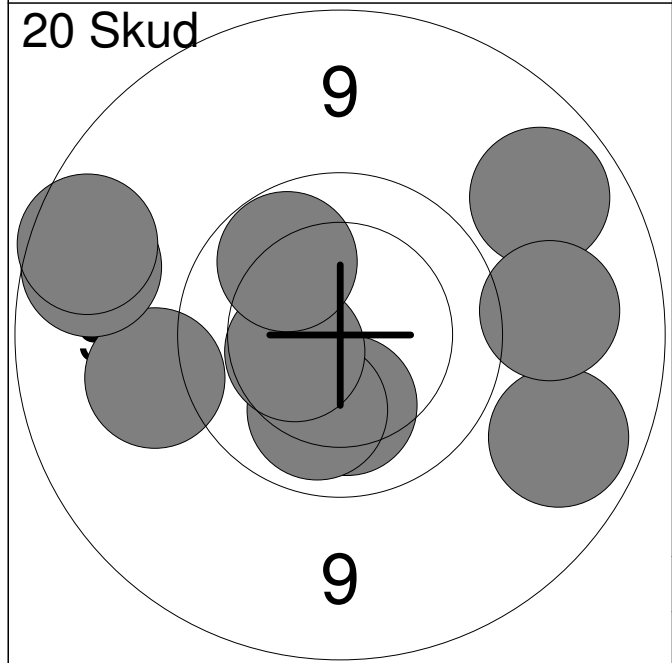

| | | |
|--------------|------|--------------|
| 11: | 9.3 | ← |
| 12: | 10.2 | ↓ |
| 13: | 10.1 | ↓ |
| 14: | 9.0 | → |
| 15: | 10.4 | ↖ |
| 16: | 10.0 | ↗ |
| 17: | 8.9 | ← |
| 18: | 8.9 | ← |
| 19: | 9.0 | ↗ |
| 20: | 9.2 | → |
| Serie | | 92.0 |
| Total | | 186.0 |

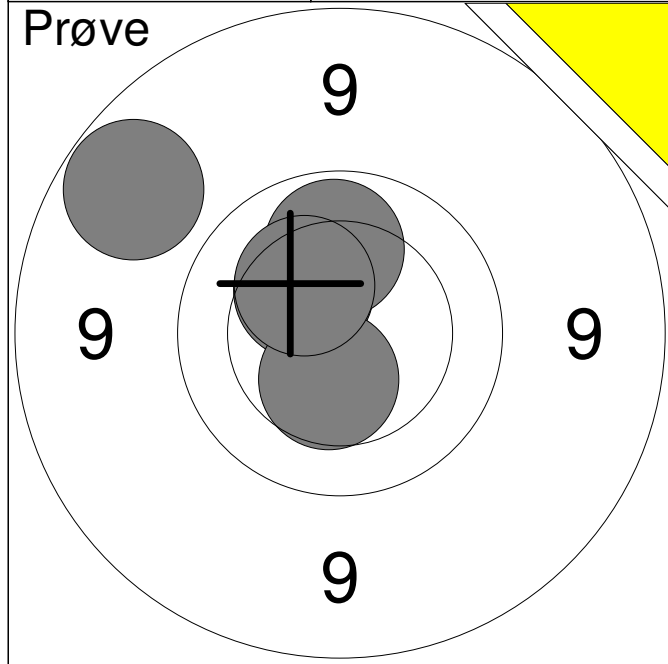

| | | |
|--------------|------|-------------|
| 1: | 9.0 | ↗ |
| 2: | 10.3 | ↗ |
| 3: | 10.0 | ↑ |
| 4: | 10.4 | ↘ |
| 5: | 10.3 | ↗ |
| Serie | | 49.0 |
| Total | | 0.0 |

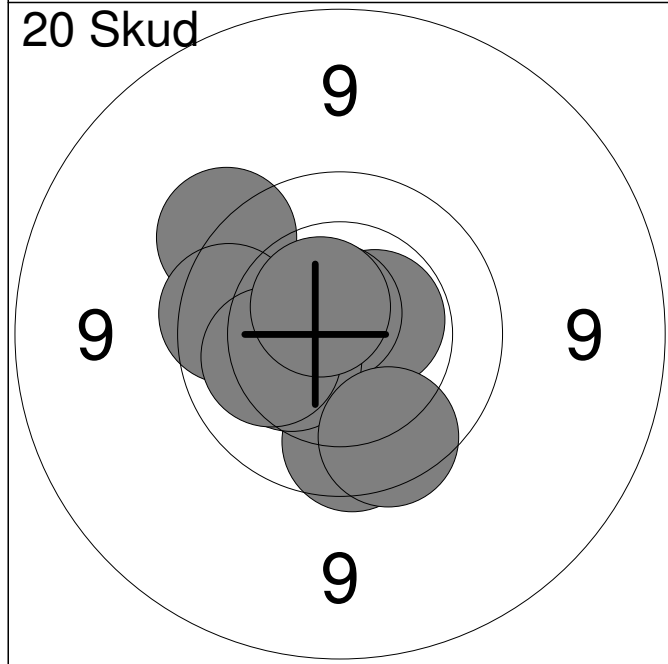

| | | |
|--------------|-------|-------------|
| 1: | 9.9 | ↓ |
| 2: | 10.5x | → |
| 3: | 9.6 | ↗ |
| 4: | 10.7x | ↑ |
| 5: | 10.2 | ← |
| 6: | 9.8 | ← |
| 7: | 10.3 | ← |
| 8: | 10.2 | ← |
| 9: | 9.8 | ↓ |
| 10: | 10.6x | ↗ |
| Serie | | 96.0 |
| Total | | 96.0 |

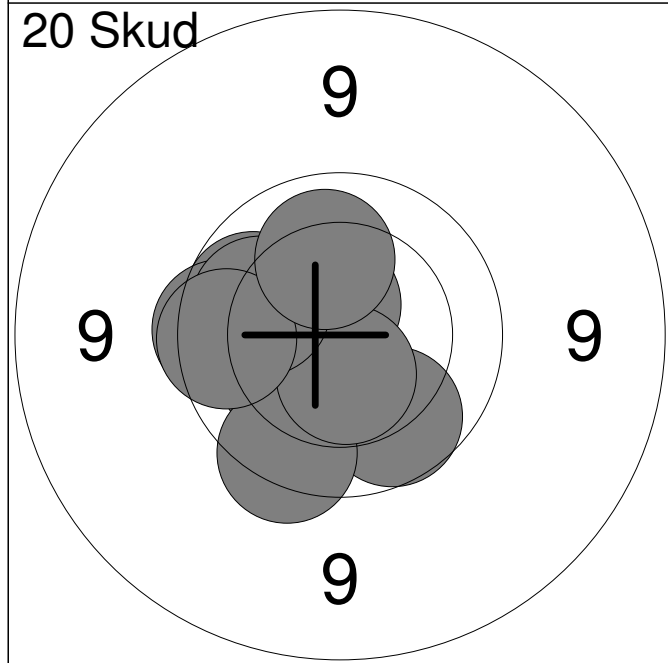

| | | |
|--------------|-------|--------------|
| 11: | 10.3 | ← |
| 12: | 9.9 | ↗ |
| 13: | 9.9 | ↓ |
| 14: | 10.6x | ↑ |
| 15: | 9.7 | ↘ |
| 16: | 10.5x | ↓ |
| 17: | 9.8 | ← |
| 18: | 10.0 | ↗ |
| 19: | 9.8 | ← |
| 20: | 10.1 | ↑ |
| Serie | | 95.0 |
| Total | | 191.0 |

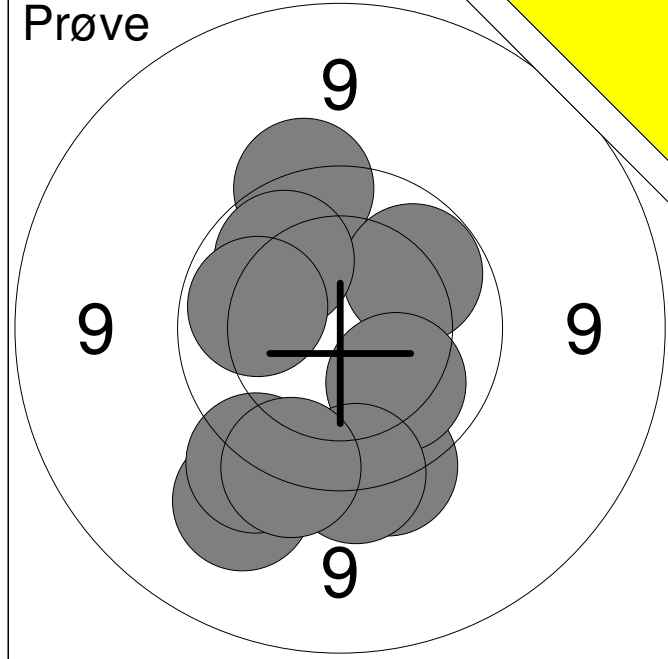

| | | |
|-----|------|---|
| 1: | 9.3 | ↙ |
| 2: | 9.6 | ↑ |
| 3: | 10.0 | ↗ |
| 4: | 9.6 | ↘ |
| 5: | 10.0 | ↗ |
| 6: | 9.5 | ↘ |
| 7: | 10.1 | ↘ |
| 8: | 9.6 | ↘ |
| 9: | 9.6 | ↘ |
| 10: | 10.0 | ↖ |

| | |
|--------------|-------------|
| Serie | 94.0 |
| Total | 0.0 |

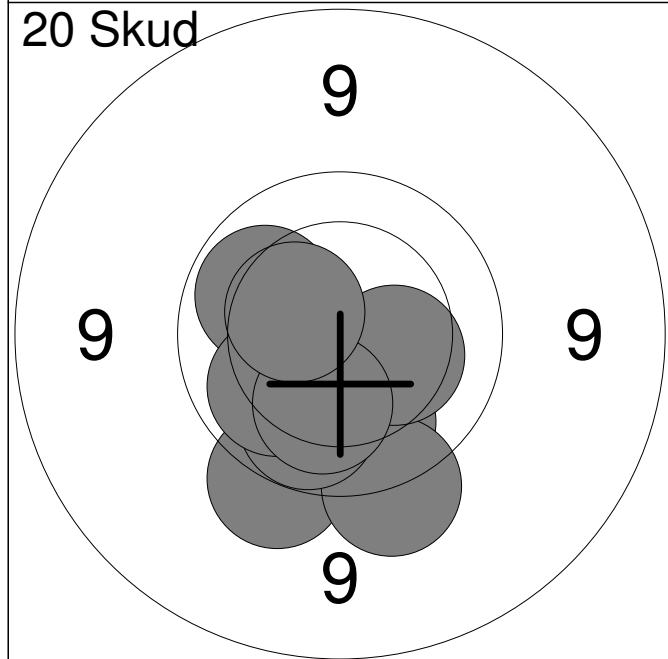

| | | |
|-----|------|---|
| 1: | 10.4 | ↙ |
| 2: | 9.6 | ↘ |
| 3: | 10.0 | ↘ |
| 4: | 9.5 | ↘ |
| 5: | 10.0 | ↘ |
| 6: | 10.3 | ↗ |
| 7: | 10.0 | ↗ |
| 8: | 10.1 | ↘ |
| 9: | 10.2 | ↘ |
| 10: | 10.4 | ↗ |

| | |
|--------------|-------------|
| Serie | 98.0 |
| Total | 98.0 |

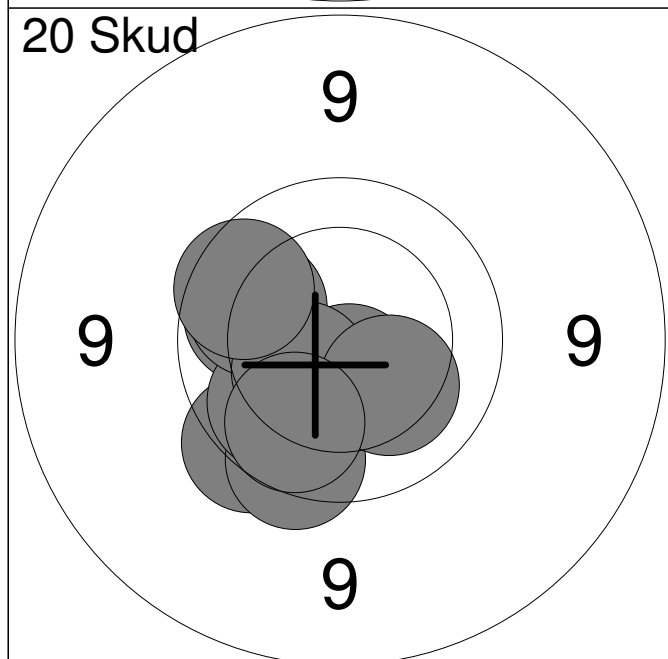

| | | |
|-----|-------|---|
| 11: | 10.0 | ↖ |
| 12: | 9.7 | ↘ |
| 13: | 9.7 | ↘ |
| 14: | 10.0 | ↘ |
| 15: | 10.0 | ↗ |
| 16: | 10.6x | ↘ |
| 17: | 10.4 | ↘ |
| 18: | 10.2 | ↘ |
| 19: | 9.9 | ↘ |
| 20: | 9.9 | ↖ |

| | |
|--------------|--------------|
| Serie | 96.0 |
| Total | 194.0 |

| | | | |
|-------------------|--------------------|-----------------------------|--|
| Hold 22 | Skive 10 | Markus Kjær Pedersen | |
|-------------------|--------------------|-----------------------------|--|

| | | | |
|-----|-----------------------------|-----|--|
| 15m | Hobro Egnens Skytteforening | BK2 | |
|-----|-----------------------------|-----|--|

| | | | |
|--|---------------------------------|---------------------|--|
| | 15 meter riffelstævne oktober 2 | Aalborg Skyttekreds | |
|--|---------------------------------|---------------------|--|

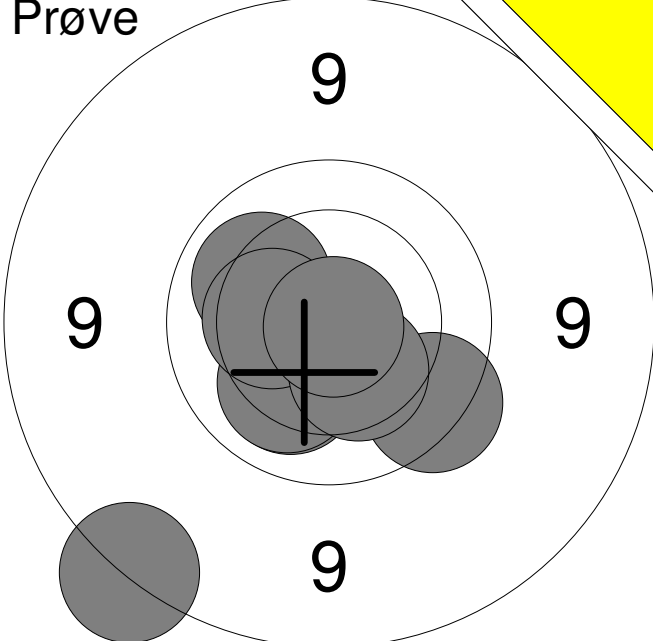
| | | | |
|--|--------------|------------|-------------|
| Prøve  | 1: | 8.7 | ↙ |
| | 2: | 10.2 | ↙ |
| | 3: | 10.2 | ↙ |
| | 4: | 10.1 | ↗ |
| | 5: | 10.3 | ← |
| | 6: | 9.7 | ↙ |
| | 7: | 10.3 | ↙ |
| | 8: | 10.9x | ↙ |
| | Serie | | 77.0 |
| Total | | 0.0 | |

| | | | |
|---|--------------|-------------|-------------|
| 20 Skud  | 1: | 10.2 | ↙ |
| | 2: | 9.8 | ↙ |
| | 3: | 10.5 | ↗ |
| | 4: | 10.2 | ↙ |
| | 5: | 10.7x | ↗ |
| | 6: | 10.5 | ← |
| | 7: | 10.3 | ← |
| | 8: | 10.1 | → |
| | 9: | 9.8 | ↙ |
| | 10: | 10.8x | ↙ |
| | Serie | | 98.0 |
| Total | | 98.0 | |

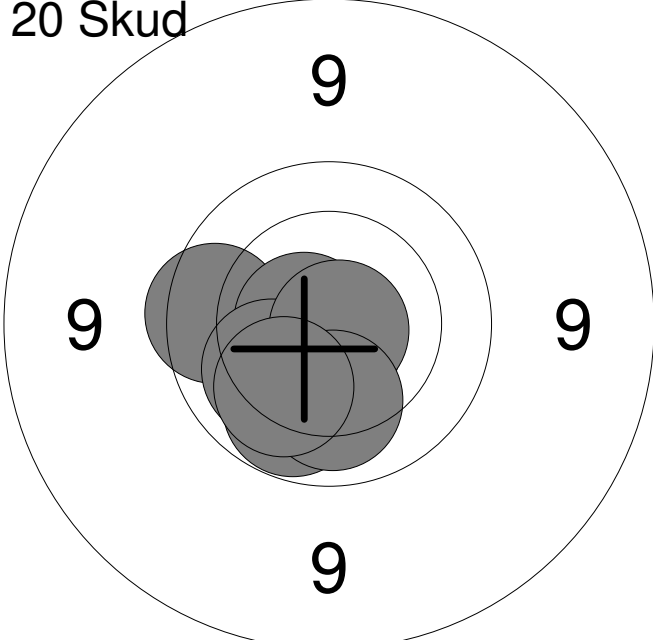
| | | | |
|--|--------------|--------------|-------------|
| 20 Skud  | 11: | 10.1 | ↙ |
| | 12: | 10.5 | ↙ |
| | 13: | 9.8 | ← |
| | 14: | 10.0 | ↙ |
| | 15: | 10.7x | ← |
| | 16: | 10.7x | ↙ |
| | 17: | 10.2 | ↙ |
| | 18: | 10.8x | ↘ |
| | 19: | 10.1 | ↙ |
| | 20: | 10.1 | ↙ |
| | Serie | | 99.0 |
| Total | | 197.0 | |

| | | | |
|-------------------|--------------------|----------------------------------|--|
| Hold 22 | Skive 11 | Christine Langbak Poulsen | |
|-------------------|--------------------|----------------------------------|--|

| | | | |
|-----|-----------------------------|-----|--|
| 15m | Hobro Egnens Skytteforening | BK2 | |
|-----|-----------------------------|-----|--|

| | | | |
|--|---------------------------------|---------------------|--|
| | 15 meter riffelstævne oktober 2 | Aalborg Skyttekreds | |
|--|---------------------------------|---------------------|--|

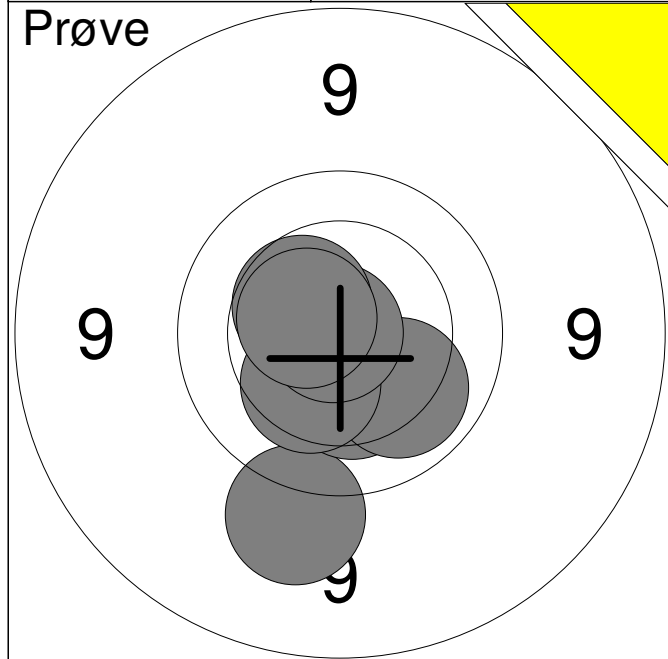

| | | |
|----|-------|---|
| 1: | 9.4 | ↘ |
| 2: | 10.3 | ↘ |
| 3: | 10.1 | ↘ |
| 4: | 10.3 | ↘ |
| 5: | 10.9x | ↖ |
| 6: | 10.4 | ↗ |
| 7: | 10.6x | ↗ |

| | |
|-------|------|
| Serie | 69.0 |
| Total | 0.0 |

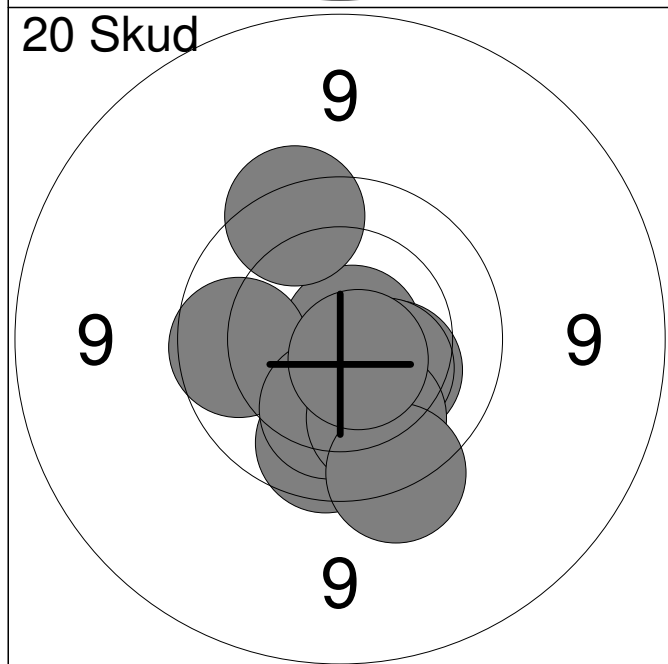

| | | |
|-----|-------|---|
| 1: | 10.8x | → |
| 2: | 9.7 | ↗ |
| 3: | 10.3 | ↘ |
| 4: | 10.4 | ↘ |
| 5: | 9.9 | ↖ |
| 6: | 9.9 | ↘ |
| 7: | 10.2 | ↘ |
| 8: | 10.0 | ↘ |
| 9: | 9.6 | ↘ |
| 10: | 10.7x | ↘ |

| | |
|-------|------|
| Serie | 96.0 |
| Total | 96.0 |

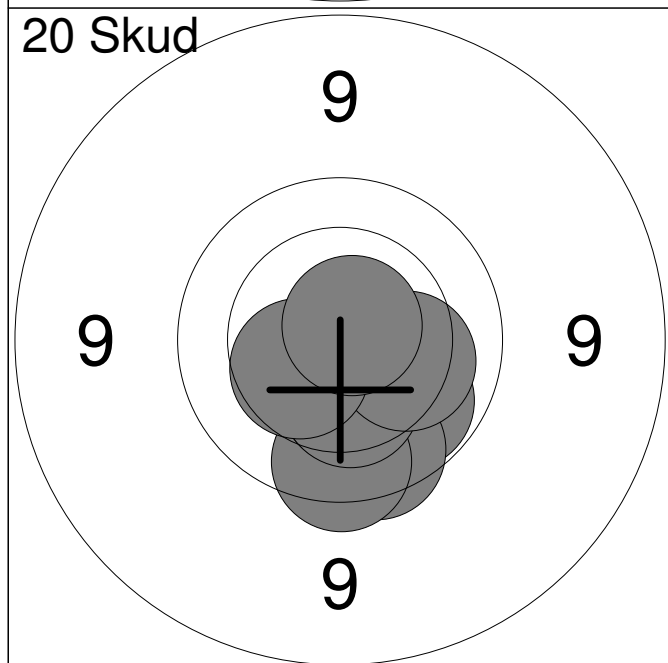

| | | |
|-----|-------|---|
| 11: | 10.2 | ↘ |
| 12: | 10.0 | ↘ |
| 13: | 9.8 | ↘ |
| 14: | 9.8 | ↘ |
| 15: | 10.3 | ↘ |
| 16: | 10.6x | ↘ |
| 17: | 10.3 | ↘ |
| 18: | 10.2 | ↗ |
| 19: | 10.4 | ↖ |
| 20: | 10.7x | ↗ |

| | |
|-------|-------|
| Serie | 98.0 |
| Total | 194.0 |

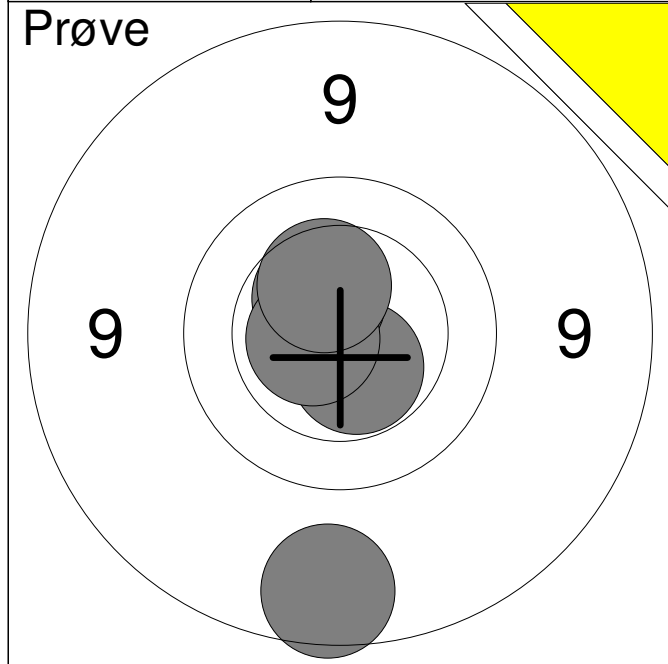

| | | |
|----|-------|---|
| 1: | 8.9 | ↓ |
| 2: | 10.5x | ↓ |
| 3: | 10.5x | ↗ |
| 4: | 10.6x | ← |
| 5: | 10.4 | ↗ |

| | |
|--------------|-------------|
| Serie | 48.0 |
| Total | 0.0 |

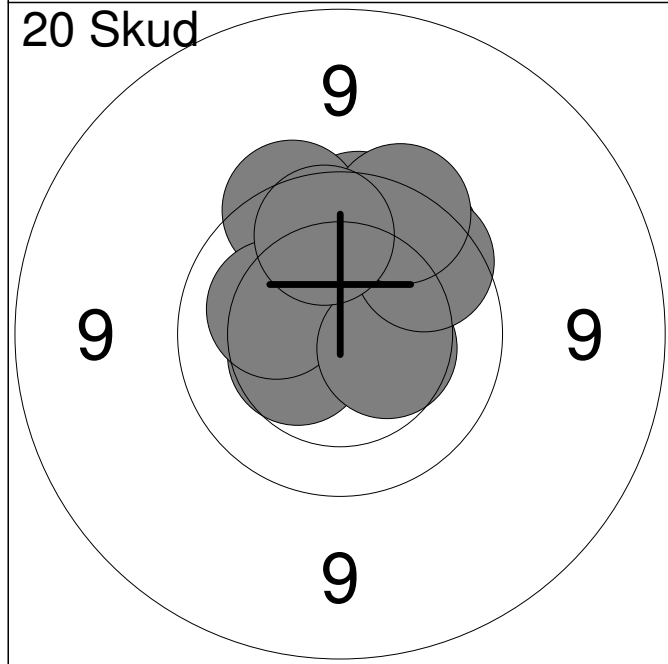

| | | |
|-----|------|---|
| 1: | 9.8 | ↑ |
| 2: | 9.7 | ↖ |
| 3: | 10.4 | ↙ |
| 4: | 9.9 | ↗ |
| 5: | 9.8 | ↗ |
| 6: | 10.2 | ↖ |
| 7: | 10.4 | → |
| 8: | 9.8 | ↗ |
| 9: | 9.7 | ↗ |
| 10: | 9.9 | ↑ |

| | |
|--------------|-------------|
| Serie | 93.0 |
| Total | 93.0 |

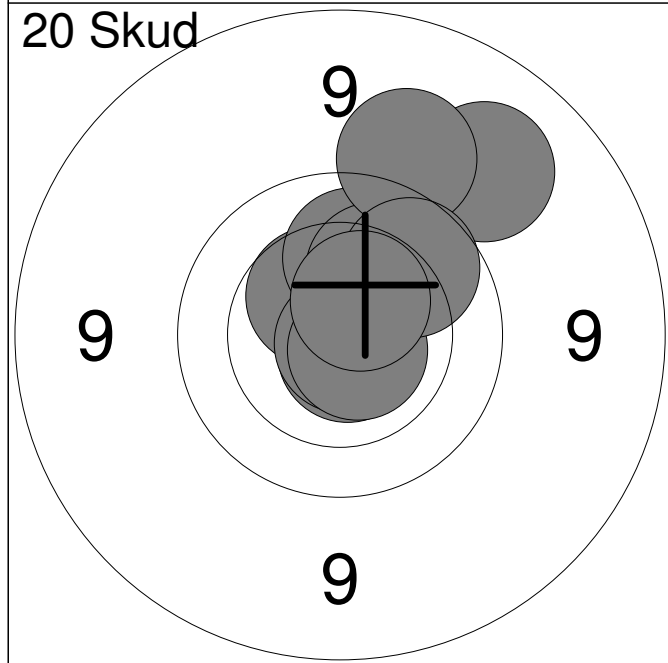

| | | |
|-----|-------|---|
| 11: | 10.5 | ↖ |
| 12: | 10.1 | ↑ |
| 13: | 10.2 | ↗ |
| 14: | 9.2 | ↗ |
| 15: | 10.7x | ↓ |
| 16: | 10.9x | ↓ |
| 17: | 10.7x | ↘ |
| 18: | 9.4 | ↑ |
| 19: | 9.9 | ↗ |
| 20: | 10.5x | ↗ |

| | |
|--------------|--------------|
| Serie | 97.0 |
| Total | 190.0 |

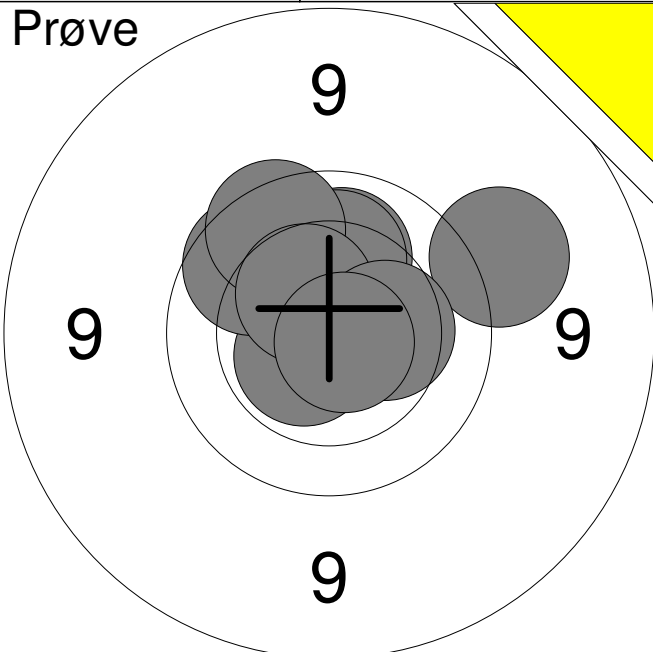
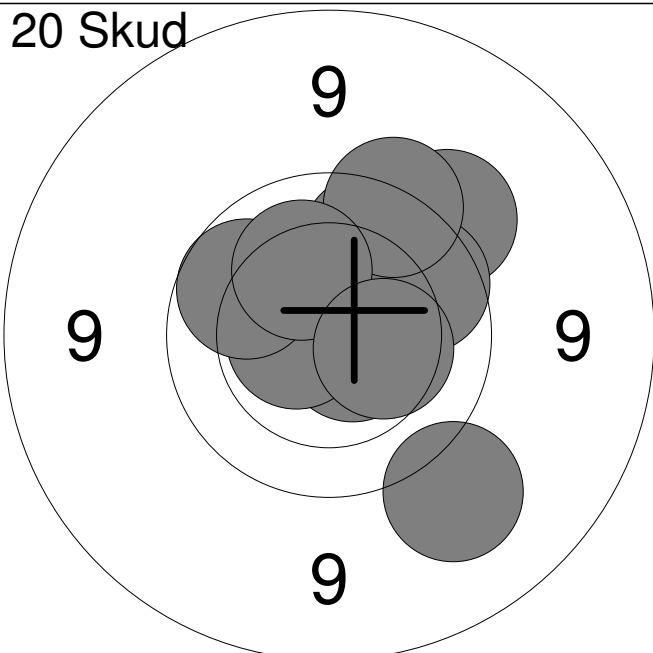
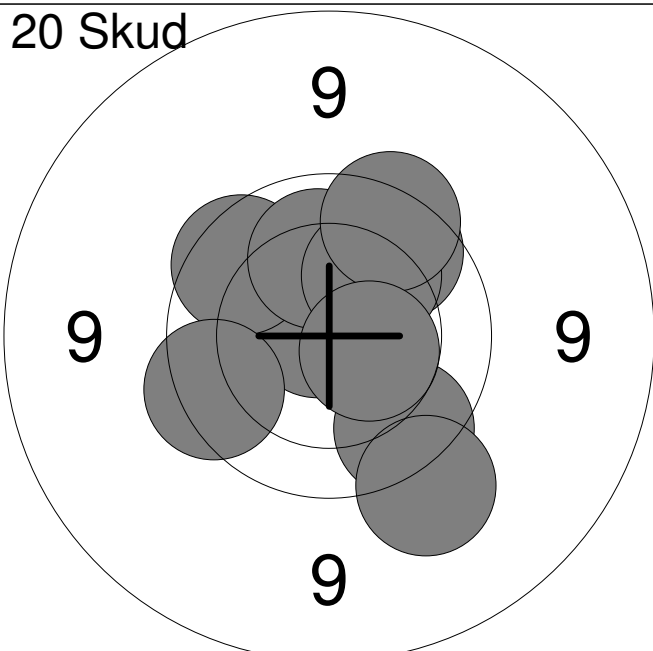
| Hold | Skive | Frederik B. Sørensen | |
|---------|--|--------------------------|--------------|
| 23 | 1 | Løgstør Sportsskytteklub | J1 |
| 15m | 15 meter riffelstævne oktober 2 | Aalborg Skyttekreds | |
| Prøve |  | 1: 9.4 → | |
| | | 2: 10.6x ↙ | |
| | | 3: 9.9 ↗ | |
| | | 4: 10.1 ↑ | |
| | | 5: 10.1 ↑ | |
| | | 6: 9.8 ↗ | |
| | | 7: 10.5 ↗ | |
| | | 8: 10.3 → | |
| | | 9: 10.8x ↘ | |
| | | Serie | 87.0 |
| | | Total | 0.0 |
| 20 Skud |  | 1: 9.3 ↘ | |
| | | 2: 10.6x ↘ | |
| | | 3: 9.9 ↑ | |
| | | 4: 9.5 ↗ | |
| | | 5: 9.9 ↗ | |
| | | 6: 10.6x ← | |
| | | 7: 9.6 ↑ | |
| | | 8: 9.9 ↗ | |
| | | 9: 10.2 ↑ | |
| | | 10: 10.3 → | |
| | | Serie | 94.0 |
| | | Total | 94.0 |
| 20 Skud |  | 11: 10.8x ↗ | |
| | | 12: 9.8 ↗ | |
| | | 13: 9.9 ↗ | |
| | | 14: 10.1 ↑ | |
| | | 15: 10.1 ↗ | |
| | | 16: 9.7 ↗ | |
| | | 17: 9.8 ↘ | |
| | | 18: 9.4 ↘ | |
| | | 19: 9.7 ← | |
| | | 20: 10.5 ↘ | |
| | | Serie | 94.0 |
| | | Total | 188.0 |

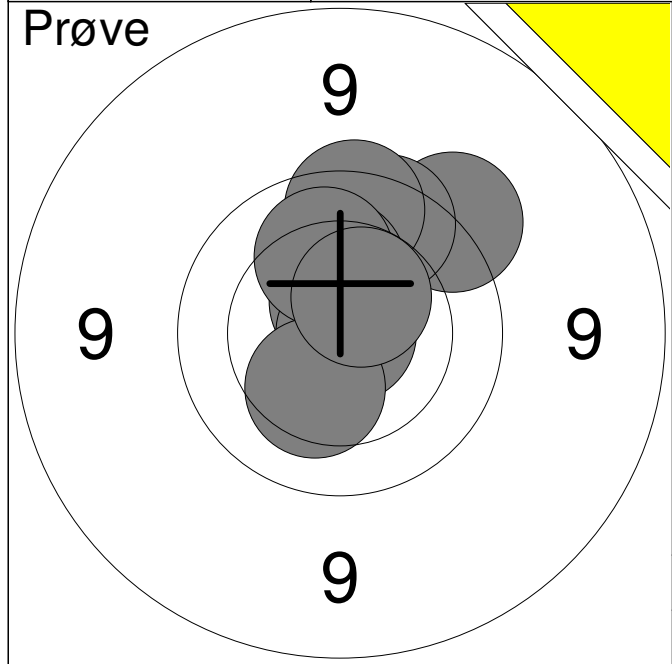

| | | |
|--------------|-------|-------------|
| 1: | 9.5 | ↗ |
| 2: | 9.8 | ↑ |
| 3: | 9.8 | ↑ |
| 4: | 10.6x | ↑ |
| 5: | 10.2 | ↑ |
| 6: | 10.9x | → |
| 7: | 10.1 | ↑ |
| 8: | 10.3 | ↓ |
| 9: | 10.5x | ↗ |
| Serie | | 87.0 |
| Total | | 0.0 |

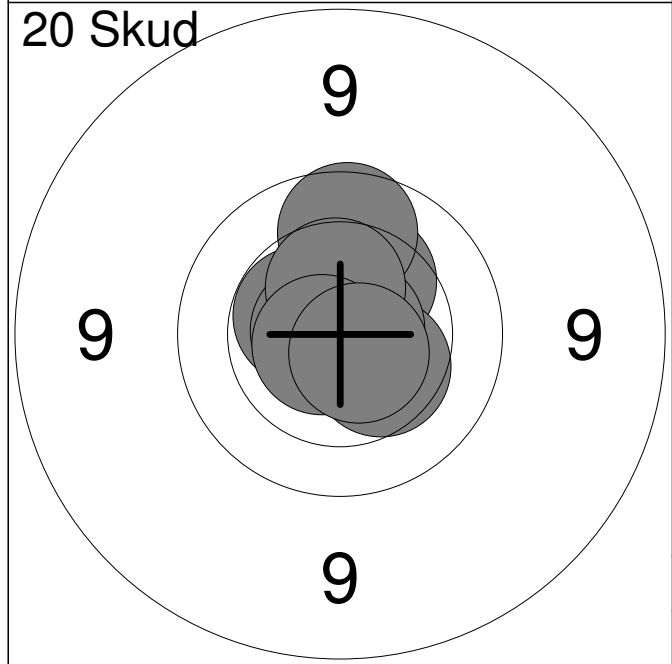

| | | |
|--------------|-------|-------------|
| 1: | 10.3 | ↗ |
| 2: | 9.9 | ↑ |
| 3: | 10.5x | ↖ |
| 4: | 10.7x | ← |
| 5: | 10.4 | ↘ |
| 6: | 10.8x | → |
| 7: | 10.7x | ← |
| 8: | 10.4 | ↑ |
| 9: | 10.7x | ↖ |
| 10: | 10.7x | ↘ |
| Serie | | 99.0 |
| Total | | 99.0 |

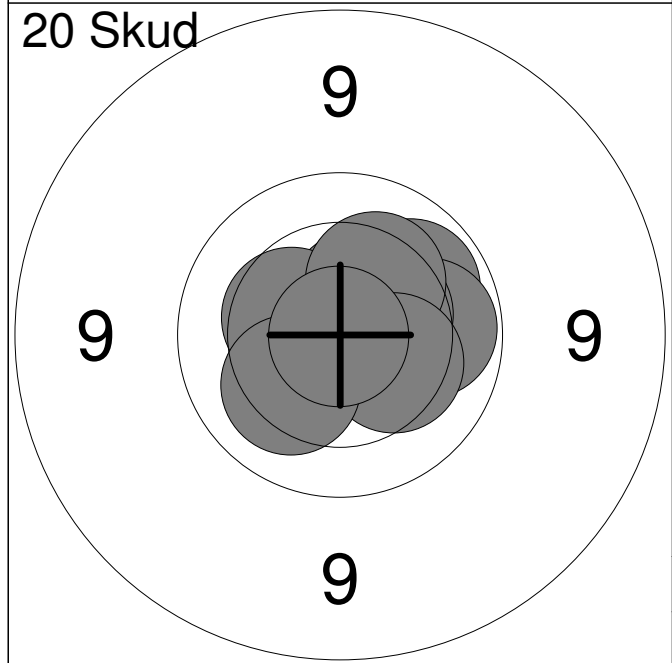

| | | |
|--------------|-------|--------------|
| 11: | 10.5x | ↗ |
| 12: | 10.4 | ↖ |
| 13: | 10.8x | ↓ |
| 14: | 10.0 | ↗ |
| 15: | 10.0 | → |
| 16: | 10.4 | ↗ |
| 17: | 10.3 | ↗ |
| 18: | 10.3 | ↘ |
| 19: | 10.2 | ↖ |
| 20: | 10.9x | ↖ |
| Serie | | 100.0 |
| Total | | 199.0 |

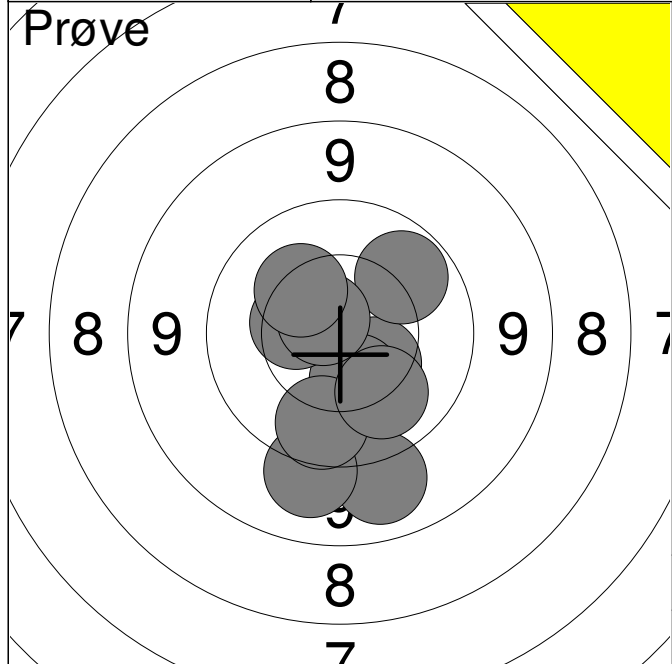

| | | |
|--------------|-------|-------------|
| 1: | 10.4 | ↘ |
| 2: | 9.1 | ↘ |
| 3: | 10.4 | ↘ |
| 4: | 10.0 | ↗ |
| 5: | 9.3 | ↘ |
| 6: | 10.4 | ↖ |
| 7: | 9.9 | ↘ |
| 8: | 10.1 | ↘ |
| 9: | 10.7x | ↗ |
| 10: | 10.3 | ↗ |
| Serie | | 97.0 |
| Total | | 0.0 |

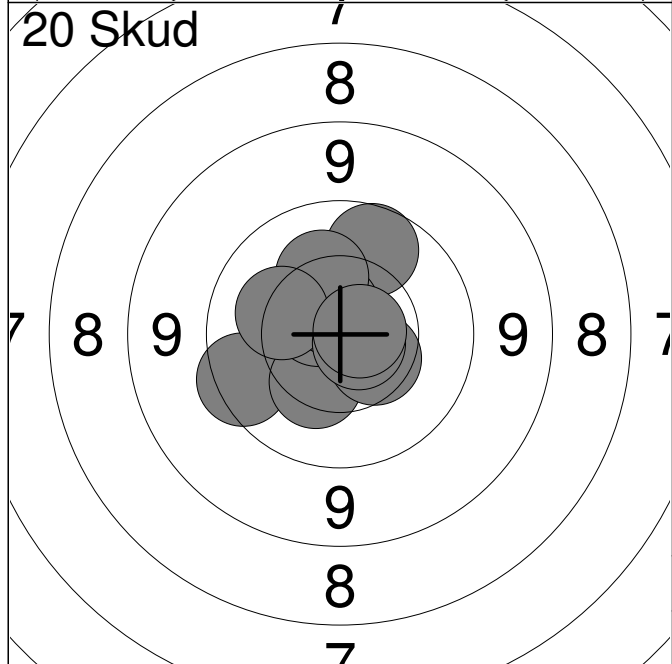

| | | |
|--------------|-------|-------------|
| 1: | 9.9 | ↗ |
| 2: | 9.7 | ↖ |
| 3: | 10.3 | ↘ |
| 4: | 10.6x | ↗ |
| 5: | 10.6x | ↗ |
| 6: | 10.2 | ↗ |
| 7: | 10.5 | ↘ |
| 8: | 10.2 | ↗ |
| 9: | 10.7x | ↘ |
| 10: | 10.7x | → |
| Serie | | 98.0 |
| Total | | 98.0 |

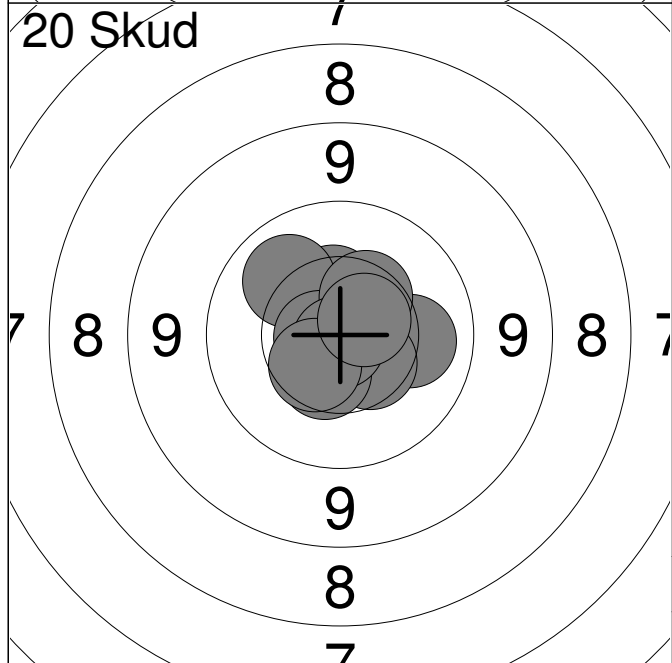

| | | |
|--------------|-------|--------------|
| 11: | 10.4 | ↗ |
| 12: | 10.1 | ↗ |
| 13: | 10.1 | → |
| 14: | 10.5 | ↘ |
| 15: | 10.7x | ↖ |
| 16: | 10.4 | ↗ |
| 17: | 10.5 | ↘ |
| 18: | 10.9x | ↘ |
| 19: | 10.5 | ↘ |
| 20: | 10.6x | ↗ |
| Serie | | 100.0 |
| Total | | 198.0 |

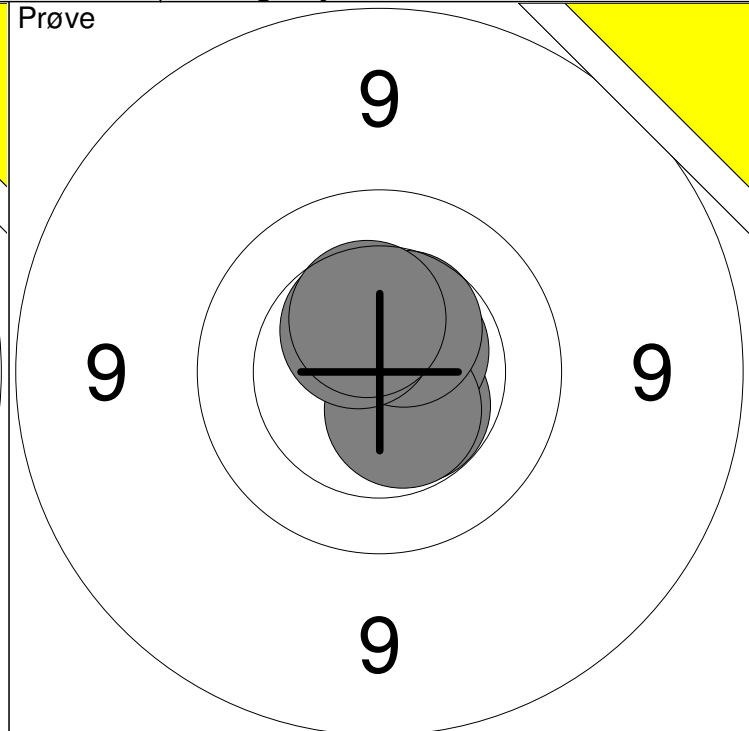
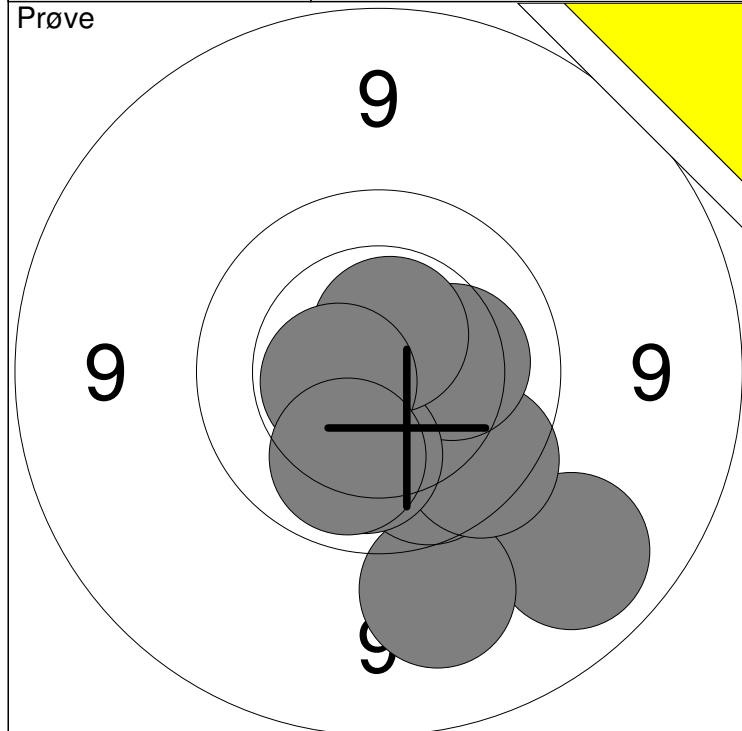

| | | | |
|-----------|------------|-------|----|
| 1: 9.1 ↘ | 6: 10.1 ↓ | Serie | 86 |
| 2: 9.3 ↘ | 8: 10.6x ↗ | | |
| 3: 9.9 ↘ | 9: 10.6x ← | Total | 0 |
| 4: 9.8 ↘ | 10: 10.1 ↓ | | |
| 5: 10.2 → | | | |

| | | | |
|-------------|------------|-------|----|
| 11: 10.5x ↘ | 16: 10.4 ↑ | Serie | 60 |
| 12: 10.6x ↗ | | | |
| 13: 10.5x ↘ | | Total | 0 |
| 14: 10.5 ↗ | | | |
| 15: 10.5x ↗ | | | |

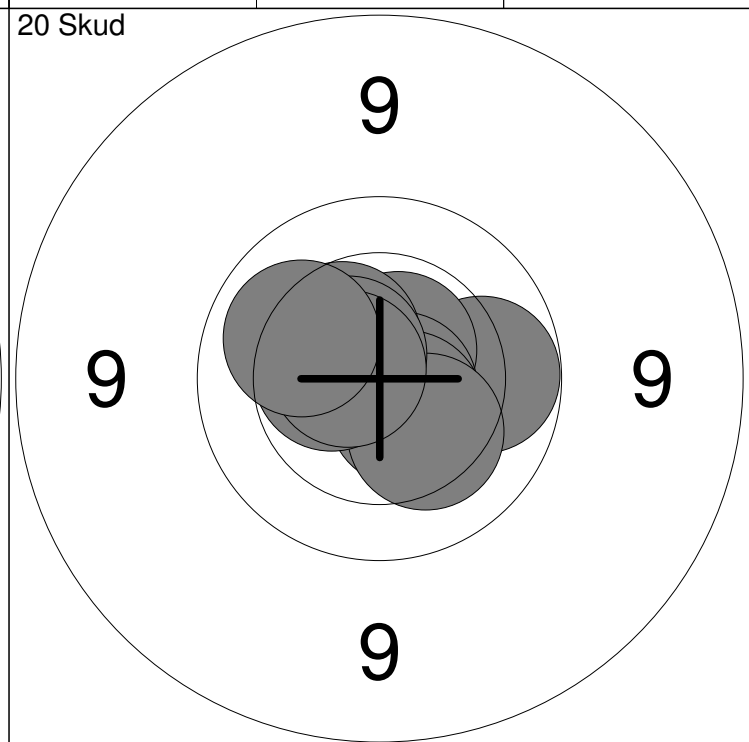
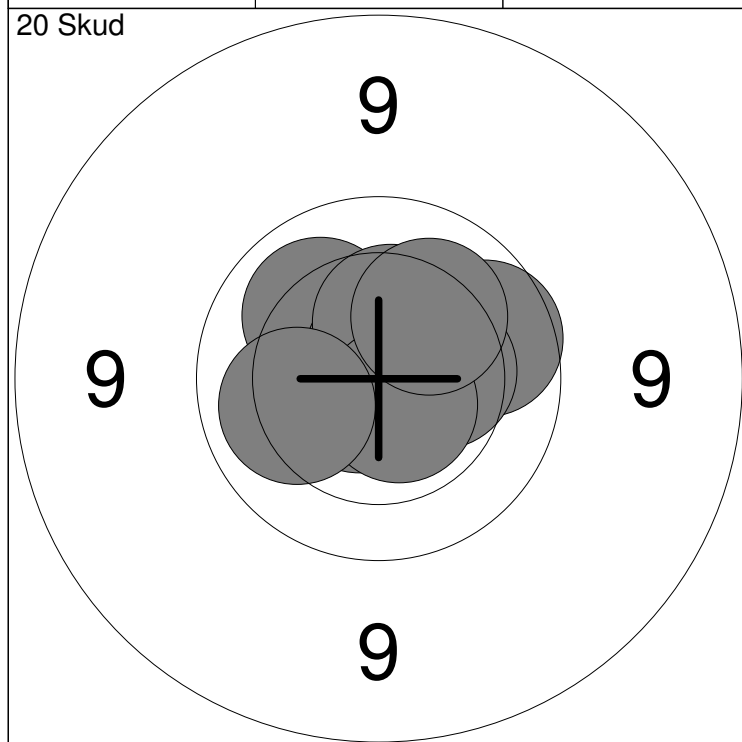

| | | | |
|------------|------------|-------|----|
| 1: 10.5x ↗ | 6: 10.7x ↖ | Serie | 99 |
| 2: 9.9 → | 7: 10.4 ↗ | | |
| 3: 10.4 → | 8: 10.6x ↘ | Total | 99 |
| 4: 10.1 ↗ | 9: 10.1 ← | | |
| 5: 10.7x ↗ | 10: 10.2 ↗ | | |

| | | | |
|-------------|-------------|-------|-----|
| 11: 10.0 → | 16: 10.4 ↗ | Serie | 100 |
| 12: 10.6x ↗ | 17: 10.6x ↗ | | |
| 13: 10.7x ↘ | 18: 10.5 ← | Total | 199 |
| 14: 10.6x ↘ | 19: 10.6x ← | | |
| 15: 10.3 ↘ | 20: 10.1 ↖ | | |

| Hold | Skive | Jørgen Thomsen | |
|---------------------------------|-----------------------------|---------------------|-----|
| 23 | 5 | | |
| 15m | Hobro Egnens Skytteforening | | MÅ1 |
| 15 meter riffelstævne oktober 2 | | Aalborg Skyttekreds | |
| Prøve | | 1: 10.2 ← | |
| | | 2: 10.4 ↗ | |
| | | 3: 10.0 ← | |
| | | 4: 10.6x ↗ | |
| | | 5: 10.6x ↗ | |
| Serie | | 50.0 | |
| Total | | 0.0 | |
| 20 Skud | | 1: 10.0 → | |
| | | 2: 10.5x ↗ | |
| | | 3: 10.7x ← | |
| | | 4: 10.4 ↗ | |
| | | 5: 10.5x ↗ | |
| | | 6: 10.4 ← | |
| | | 7: 10.6x ← | |
| | | 8: 10.7x ← | |
| | | 9: 10.7x → | |
| | | 10: 9.9 ↗ | |
| Serie | | 99.0 | |
| Total | | 99.0 | |
| 20 Skud | | 11: 10.3 ↑ | |
| | | 12: 10.3 ↑ | |
| | | 13: 10.5x → | |
| | | 14: 10.4 ↓ | |
| | | 15: 10.6x → | |
| | | 16: 10.4 → | |
| | | 17: 10.7x ↓ | |
| | | 18: 10.1 ↗ | |
| | | 19: 10.0 ← | |
| | | 20: 10.8x ↗ | |
| Serie | | 100.0 | |
| Total | | 199.0 | |

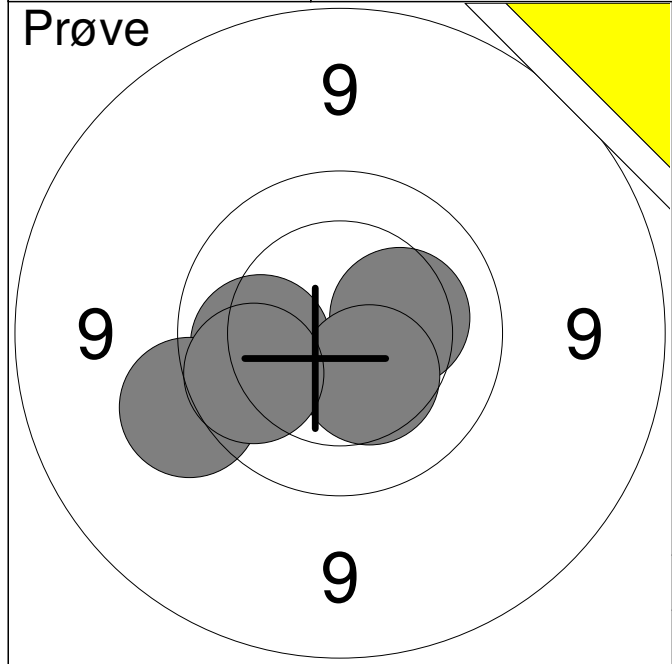

| | | |
|--------------|------|-------------|
| 1: | 10.3 | → |
| 2: | 10.1 | ← |
| 3: | 9.5 | ↙ |
| 4: | 10.4 | ↘ |
| 5: | 9.9 | ↙ |
| Serie | | 48.0 |
| Total | | 0.0 |

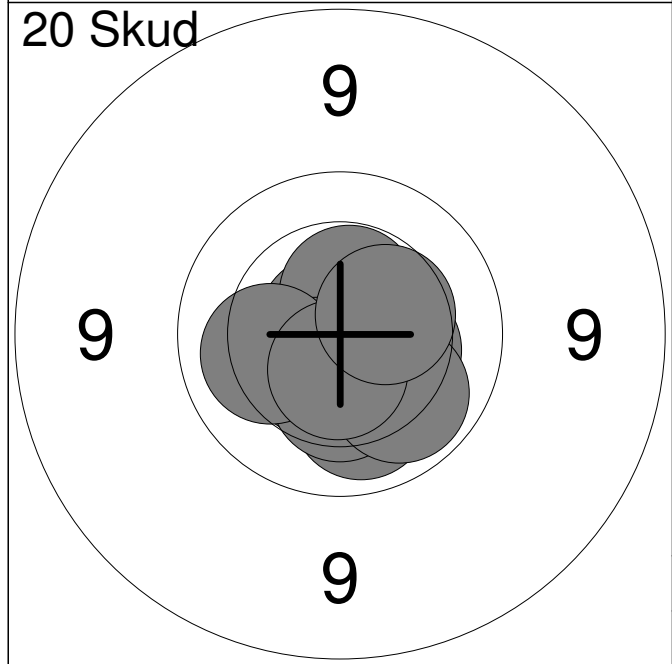

| | | |
|--------------|-------|--------------|
| 1: | 10.8x | ↗ |
| 2: | 10.1 | ↘ |
| 3: | 10.4 | → |
| 4: | 10.5x | ↑ |
| 5: | 10.5x | ↙ |
| 6: | 10.3 | ↘ |
| 7: | 10.0 | ↘ |
| 8: | 10.2 | ← |
| 9: | 10.6x | ↘ |
| 10: | 10.4 | → |
| Serie | | 100.0 |
| Total | | 100.0 |

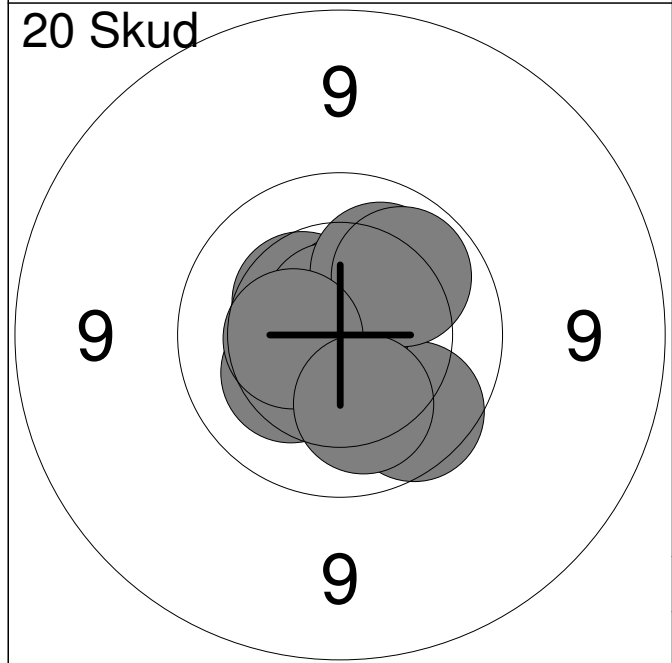

| | | |
|--------------|-------|--------------|
| 11: | 9.9 | ↘ |
| 12: | 10.4 | ↗ |
| 13: | 10.8x | ↑ |
| 14: | 10.6x | ↑ |
| 15: | 10.3 | ↙ |
| 16: | 10.7x | ↑ |
| 17: | 10.1 | ↗ |
| 18: | 10.0 | ↗ |
| 19: | 10.4 | ← |
| 20: | 10.2 | ↘ |
| Serie | | 99.0 |
| Total | | 199.0 |

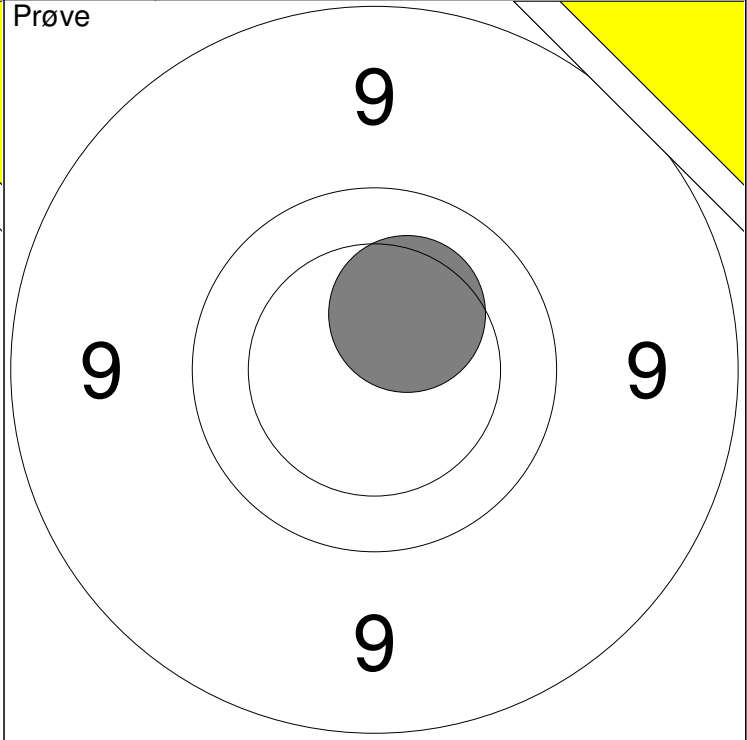
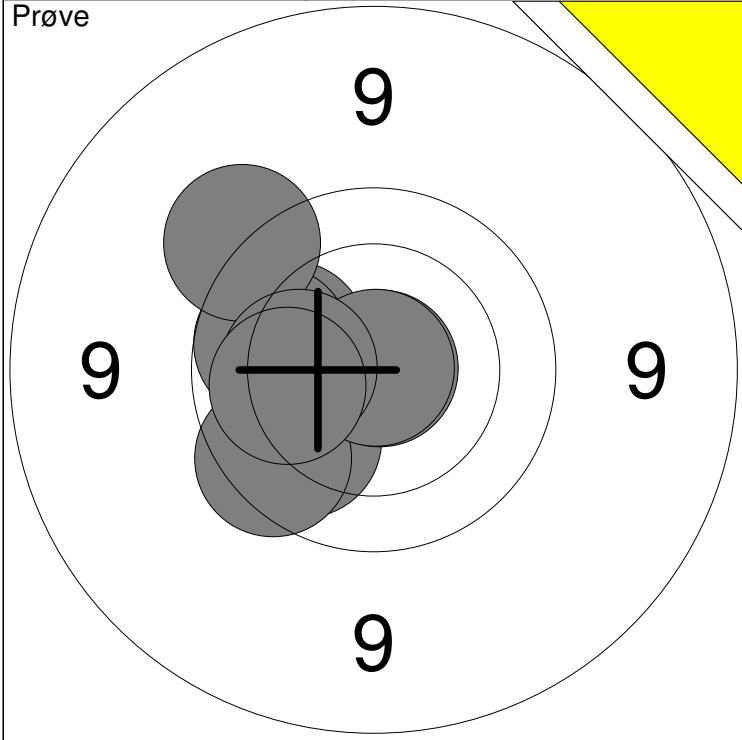

| | | | |
|------------|------------|-------|----|
| 1: 10.0 ↙ | 6: 9.9 ← | Serie | 97 |
| 2: 9.8 ↙ | 7: 9.5 ↗ | | |
| 3: 10.9x → | 8: 10.9x ↗ | Total | 0 |
| 4: 10.1 ← | 9: 10.2 ← | | |
| 5: 10.1 ← | 10: 10.1 ← | | |

| | | |
|------------|-------|----|
| 11: 10.3 ↗ | Serie | 10 |
| | | |
| | Total | 0 |
| | | |

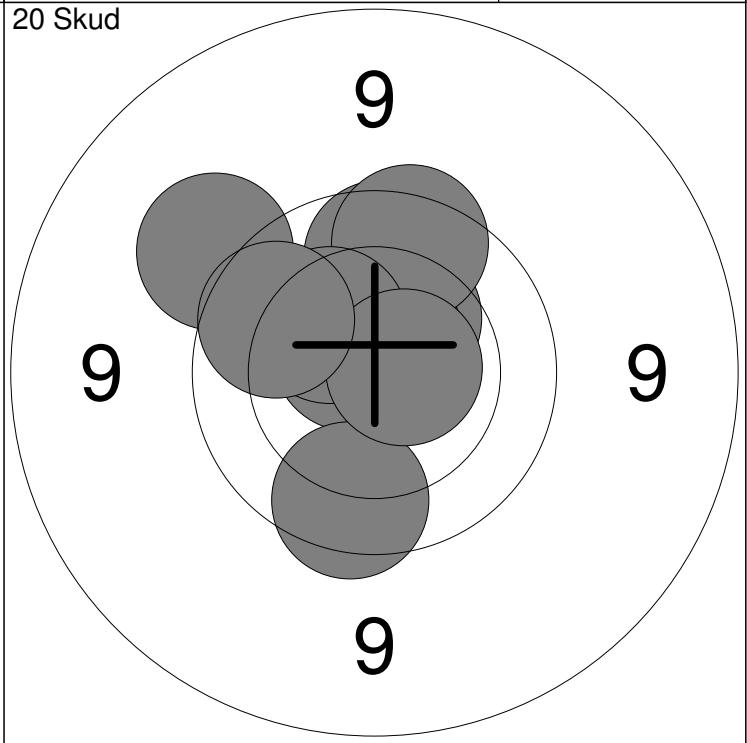
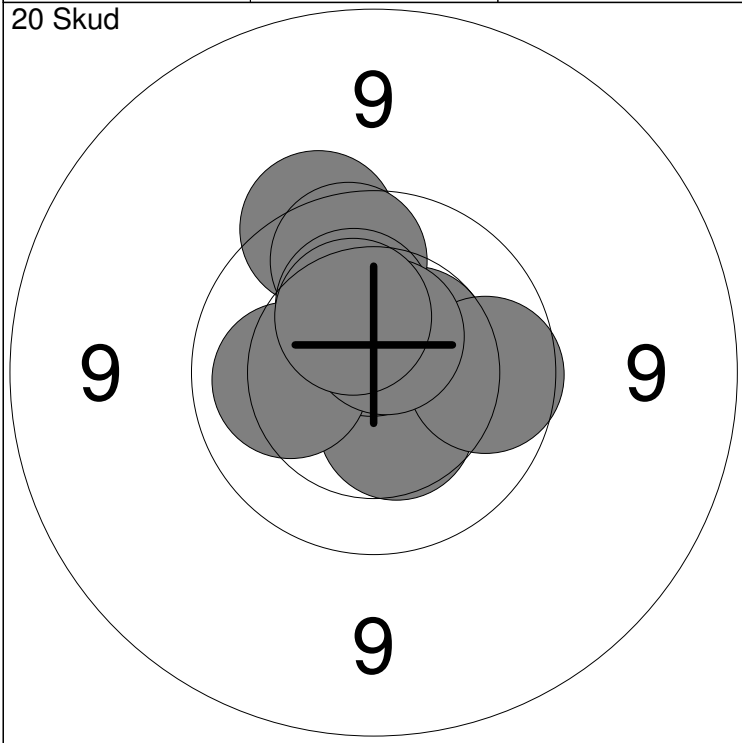

| | | | |
|------------|------------|-------|----|
| 1: 10.5x ↗ | 6: 10.3 ↗ | Serie | 97 |
| 2: 9.7 ↗ | 7: 9.9 → | | |
| 3: 9.9 ↗ | 8: 10.1 ← | Total | 97 |
| 4: 10.4 ↓ | 9: 10.6x ↗ | | |
| 5: 10.6x ↗ | 10: 10.4 ↗ | | |

| | | | |
|-------------|-------------|-------|-----|
| 11: 9.4 ↗ | 16: 9.8 ↓ | Serie | 95 |
| 12: 10.7x ↗ | 17: 9.8 ↗ | | |
| 13: 10.4 ↗ | 18: 10.3 ↗ | Total | 192 |
| 14: 10.6x ↗ | 19: 10.7x → | | |
| 15: 9.9 ↗ | 20: 9.9 ↗ | | |

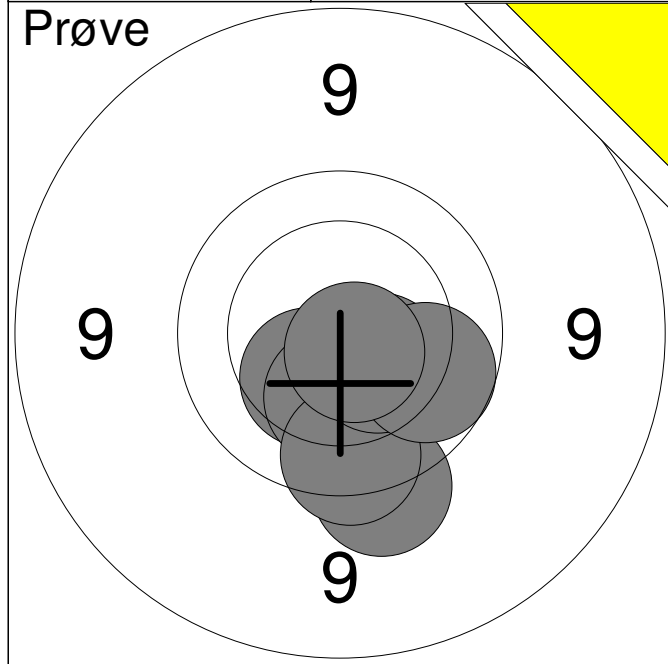

| | | |
|----|-------|---|
| 1: | 9.5 | ↘ |
| 2: | 10.4 | ↘ |
| 3: | 10.3 | ↘ |
| 4: | 9.8 | ↘ |
| 5: | 10.4 | ↘ |
| 6: | 9.9 | ↘ |
| 7: | 10.7x | ↘ |

| | |
|-------|------|
| Serie | 67.0 |
| Total | 0.0 |

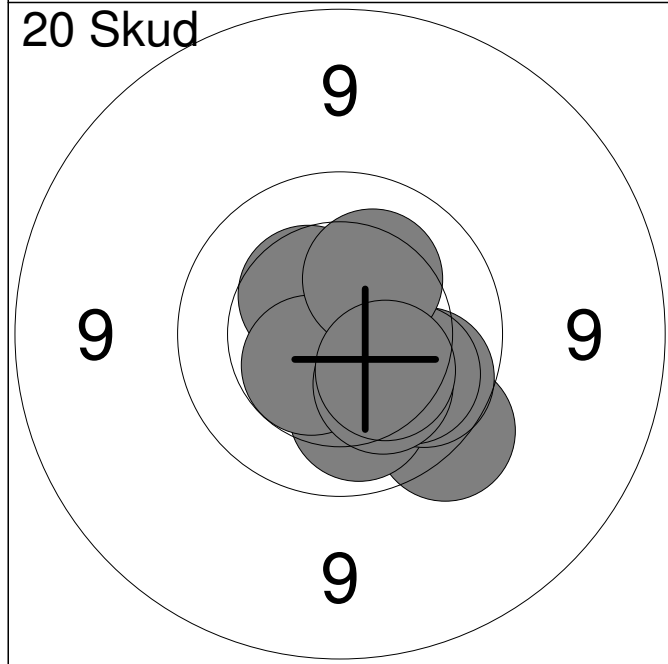

| | | |
|-----|-------|---|
| 1: | 9.6 | ↘ |
| 2: | 10.1 | ↘ |
| 3: | 9.9 | ↘ |
| 4: | 10.4 | ↗ |
| 5: | 10.7x | ↘ |
| 6: | 10.1 | ↘ |
| 7: | 10.5x | ↘ |
| 8: | 10.2 | ↘ |
| 9: | 10.3 | ↗ |
| 10: | 10.3 | ↘ |

| | |
|-------|------|
| Serie | 98.0 |
| Total | 98.0 |

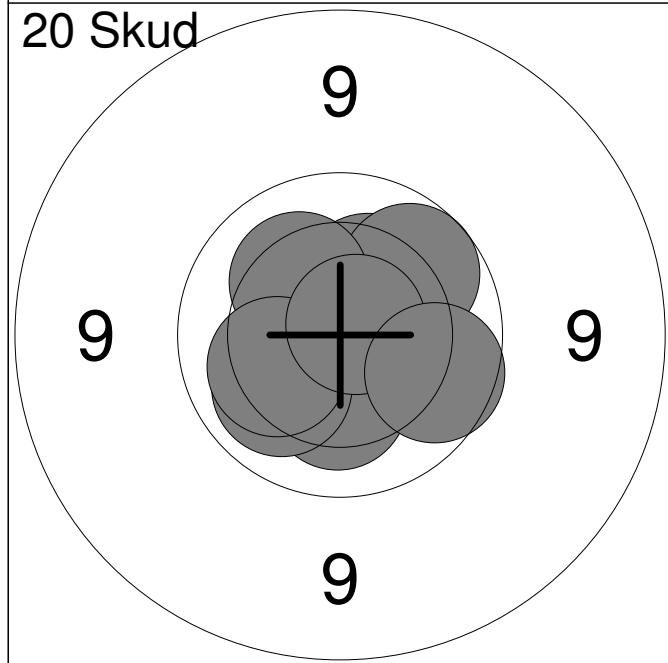

| | | |
|-----|-------|---|
| 11: | 10.7x | ↗ |
| 12: | 10.2 | ↘ |
| 13: | 10.6x | ↗ |
| 14: | 10.3 | ↗ |
| 15: | 10.0 | ↗ |
| 16: | 10.1 | ↘ |
| 17: | 10.2 | ↗ |
| 18: | 10.2 | ↘ |
| 19: | 10.7x | ↗ |
| 20: | 9.9 | ↘ |

| | |
|-------|-------|
| Serie | 99.0 |
| Total | 197.0 |

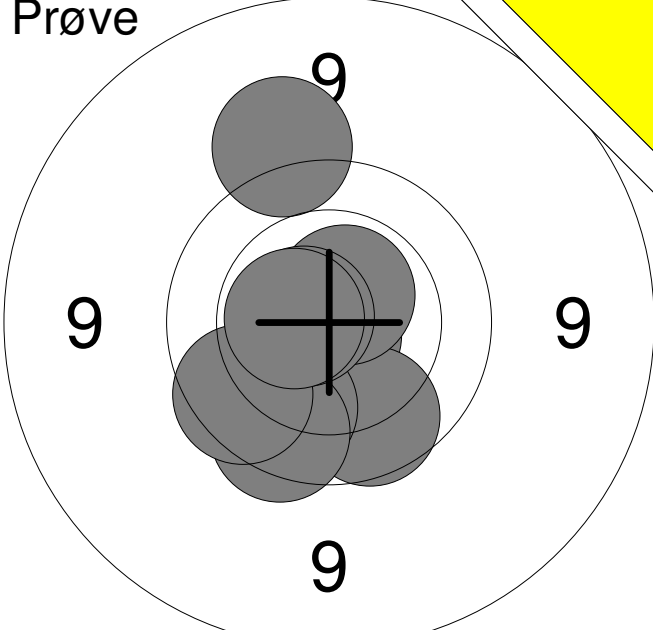
| | | | |
|--|--------------|------------|-------------|
| Prøve  | 1: | 10.8x | ↓ |
| | 2: | 9.9 | ↓ |
| | 3: | 9.9 | ↓ |
| | 4: | 9.8 | ↓ |
| | 5: | 10.6x | ↗ |
| | 6: | 9.4 | ↗ |
| | 7: | 10.7x | ← |
| | 8: | 9.8 | ↙ |
| | 9: | 10.6x | ← |
| | Serie | | 85.0 |
| Total | | 0.0 | |

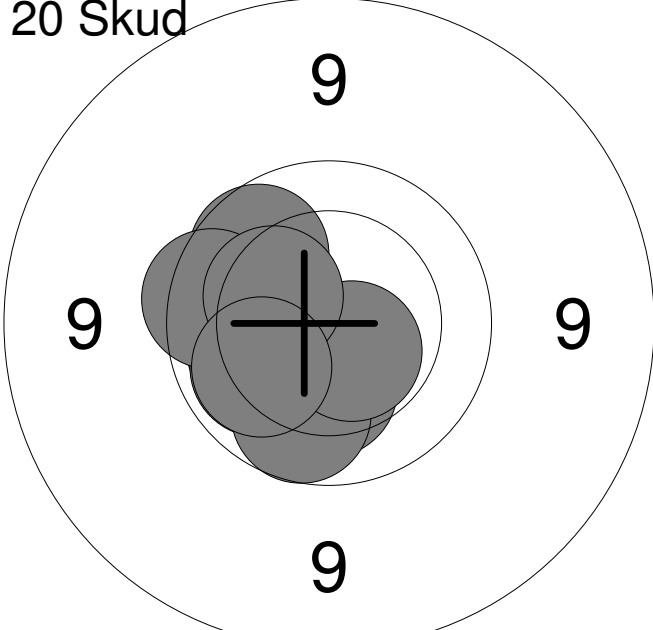
| | | | |
|---|-----|-------------|---|
| 20 Skud  | 1: | 9.9 | ↖ |
| | 2: | 10.4 | ↙ |
| | 3: | 10.1 | ← |
| | 4: | 10.1 | ↙ |
| | 5: | 10.3 | ↓ |
| | 6: | 9.9 | ↓ |
| | 7: | 10.6x | ↓ |
| | 8: | 9.8 | ← |
| | 9: | 10.3 | ↖ |
| | 10: | 10.1 | ↙ |
| Serie | | 97.0 | |
| Total | | 97.0 | |

| | | | |
|--|-----|--------------|---|
| 20 Skud  | 11: | 9.6 | ← |
| | 12: | 10.5x | ← |
| | 13: | 9.8 | ↙ |
| | 14: | 10.0 | ↙ |
| | 15: | 10.1 | ↙ |
| | 16: | 10.0 | ← |
| | 17: | 9.9 | ↙ |
| | 18: | 10.2 | ← |
| | 19: | 10.9x | ↙ |
| | 20: | 10.1 | ↗ |
| Serie | | 97.0 | |
| Total | | 194.0 | |

| | | | |
|-------------------|--------------------|-----------------------------|--|
| Hold 23 | Skive 10 | Markus Kjær Pedersen | |
|-------------------|--------------------|-----------------------------|--|

| | | | |
|-----|-----------------------------|-----|--|
| 15m | Hobro Egnens Skytteforening | MB2 | |
|-----|-----------------------------|-----|--|

| | | | |
|--|---------------------------------|---------------------|--|
| | 15 meter riffelstævne oktober 2 | Aalborg Skyttekreds | |
|--|---------------------------------|---------------------|--|

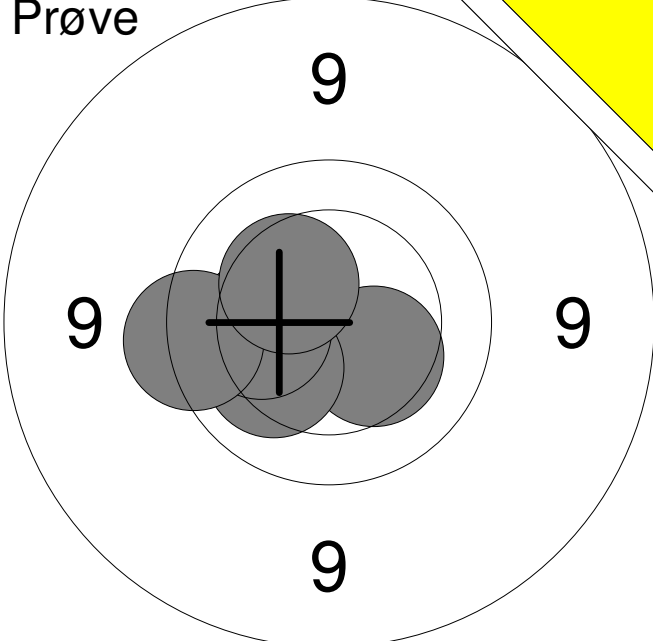
| | | | |
|--|--------------|------------|-------------|
| Prøve  | 1: | 10.3 | ↘ |
| | 2: | 10.2 | ↙ |
| | 3: | 10.2 | ← |
| | 4: | 9.7 | ↖ |
| | 5: | 10.4 | ↗ |
| | Serie | | 49.0 |
| Total | | 0.0 | |

| | | | |
|---|--------------|-------------|-------------|
| 20 Skud  | 1: | 9.9 | ↓ |
| | 2: | 9.8 | ↙ |
| | 3: | 9.6 | ↑ |
| | 4: | 10.0 | ↓ |
| | 5: | 10.9x | ↑ |
| | 6: | 10.0 | ↗ |
| | 7: | 10.0 | → |
| | 8: | 10.3 | ↗ |
| | 9: | 10.5x | ↙ |
| | 10: | 9.7 | ← |
| | Serie | | 96.0 |
| Total | | 96.0 | |

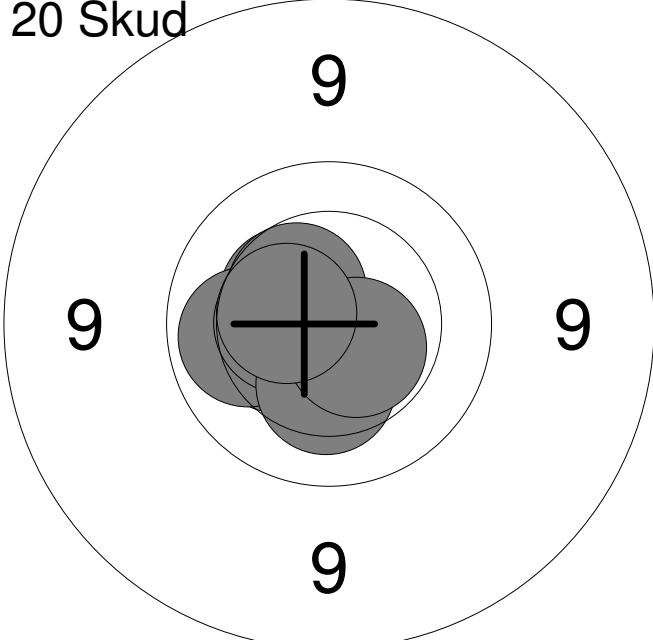
| | | | |
|--|--------------|--------------|--------------|
| 20 Skud  | 11: | 10.4 | ↗ |
| | 12: | 10.6x | ↙ |
| | 13: | 10.4 | ← |
| | 14: | 10.8x | ↓ |
| | 15: | 10.1 | ← |
| | 16: | 10.5 | ← |
| | 17: | 10.3 | ↓ |
| | 18: | 10.5 | ↗ |
| | 19: | 10.6x | ↘ |
| | 20: | 10.5 | ← |
| | Serie | | 100.0 |
| Total | | 196.0 | |

| | | | |
|-------------------|--------------------|----------------------------------|--|
| Hold 23 | Skive 11 | Christine Langbak Poulsen | |
|-------------------|--------------------|----------------------------------|--|

| | | | |
|-----|-----------------------------|-----|--|
| 15m | Hobro Egnens Skytteforening | MB2 | |
|-----|-----------------------------|-----|--|

| | | | |
|--|---------------------------------|---------------------|--|
| | 15 meter riffelstævne oktober 2 | Aalborg Skyttekreds | |
|--|---------------------------------|---------------------|--|

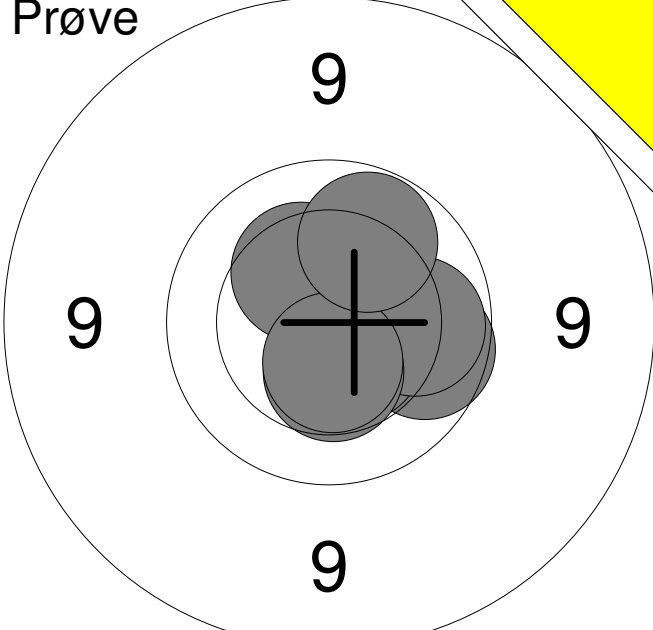
| | | | |
|--|--------------|-------|------------|
| Prøve  | 1: | 9.9 | → |
| | 2: | 10.5x | ↘ |
| | 3: | 10.0 | → |
| | 4: | 10.3 | ↗ |
| | 5: | 10.4 | ↘ |
| | 6: | 10.5x | ↘ |
| | 7: | 10.0 | ↗ |
| | Serie | | |
| Total | | | 0.0 |

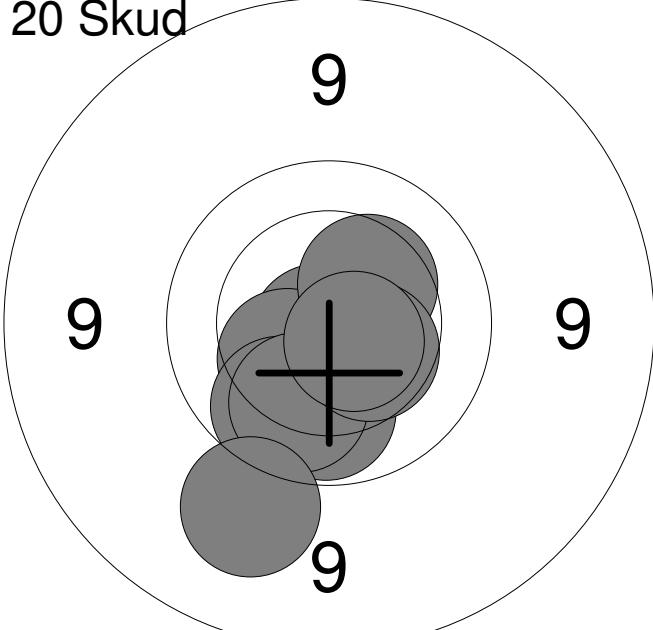
| | | | |
|---|--------------|-------|-------------|
| 20 Skud  | 1: | 10.8x | ↙ |
| | 2: | 10.2 | ↘ |
| | 3: | 10.4 | ↙ |
| | 4: | 10.4 | ↗ |
| | 5: | 9.9 | ↘ |
| | 6: | 10.0 | ↘ |
| | 7: | 10.0 | ↘ |
| | 8: | 9.3 | ↘ |
| | 9: | 10.4 | ↘ |
| | 10: | 10.6x | ↘ |
| | Serie | | |
| Total | | | 98.0 |

| | | | |
|--|--------------|-------|--------------|
| 20 Skud  | 11: | 10.2 | ↘ |
| | 12: | 10.8x | ↘ |
| | 13: | 10.3 | ↘ |
| | 14: | 10.7x | ← |
| | 15: | 10.1 | ↘ |
| | 16: | 10.5x | ← |
| | 17: | 10.0 | ↙ |
| | 18: | 10.4 | ↙ |
| | 19: | 9.8 | ← |
| | 20: | 10.1 | ← |
| | Serie | | |
| Total | | | 197.0 |

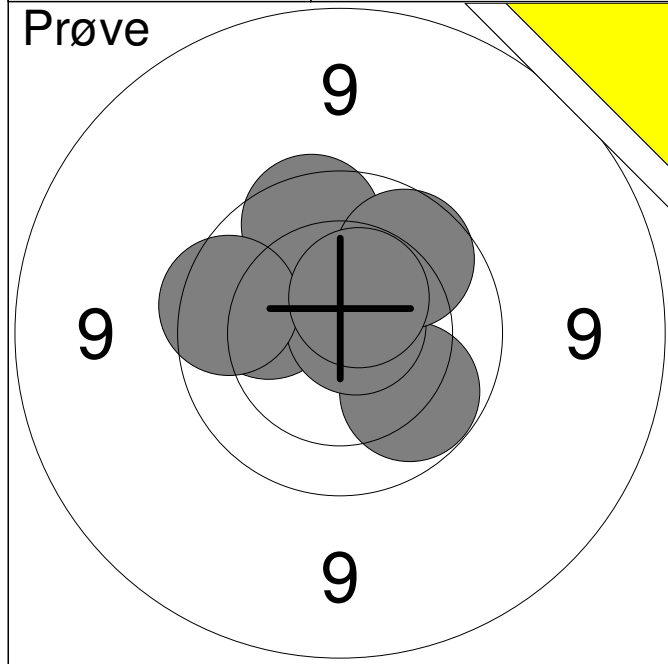

| | | |
|--------------|-------|-------------|
| 1: | 10.0 | ↘ |
| 2: | 10.1 | ↖ |
| 3: | 10.8x | ↗ |
| 4: | 9.8 | ↗ |
| 5: | 9.9 | ↗ |
| 6: | 9.8 | ↖ |
| 7: | 10.5x | ↗ |
| Serie | | 67.0 |
| Total | | 0.0 |

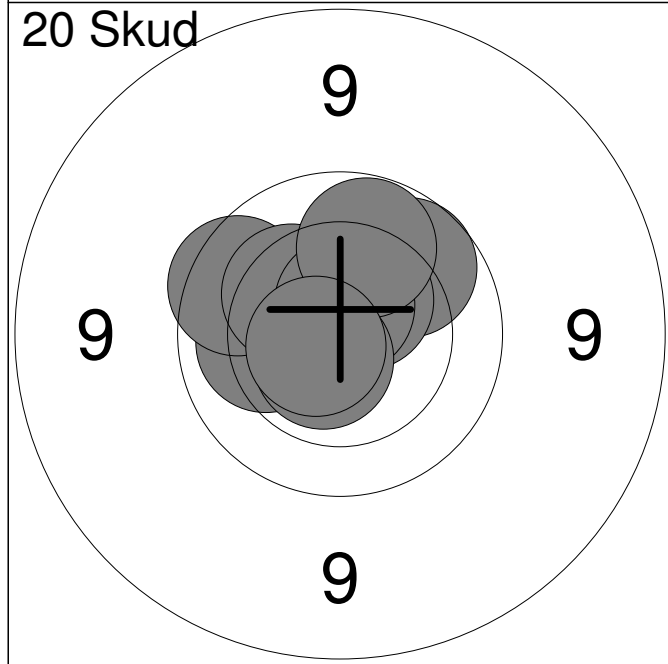

| | | |
|--------------|-------|-------------|
| 1: | 10.1 | ↖ |
| 2: | 10.8x | ↗ |
| 3: | 9.8 | ↖ |
| 4: | 9.9 | ↗ |
| 5: | 10.3 | ↖ |
| 6: | 10.5x | ↗ |
| 7: | 10.6x | ↗ |
| 8: | 10.0 | ↗ |
| 9: | 10.6x | ↘ |
| 10: | 10.7x | ↖ |
| Serie | | 98.0 |
| Total | | 98.0 |

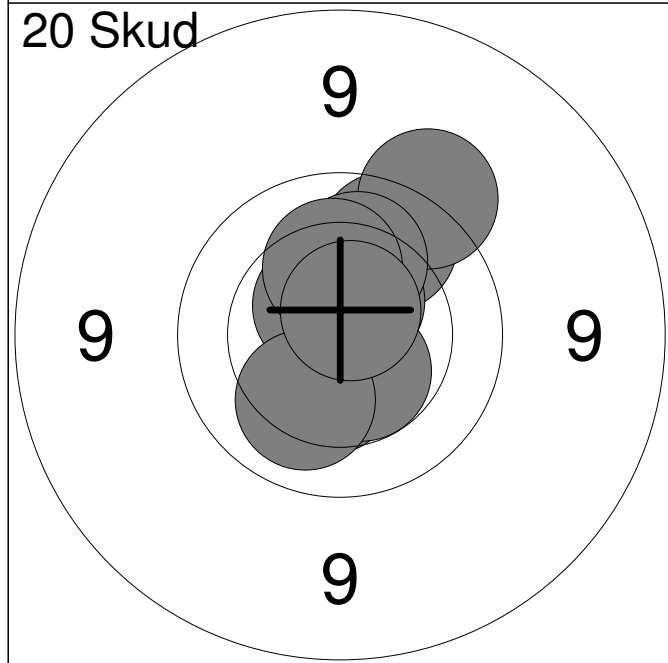

| | | |
|--------------|-------|--------------|
| 11: | 9.9 | ↗ |
| 12: | 10.4 | ↘ |
| 13: | 10.6x | ↗ |
| 14: | 10.6x | ↖ |
| 15: | 9.5 | ↗ |
| 16: | 10.5x | ↘ |
| 17: | 10.1 | ↗ |
| 18: | 10.2 | ↘ |
| 19: | 10.2 | ↗ |
| 20: | 10.7x | ↗ |
| Serie | | 98.0 |
| Total | | 196.0 |

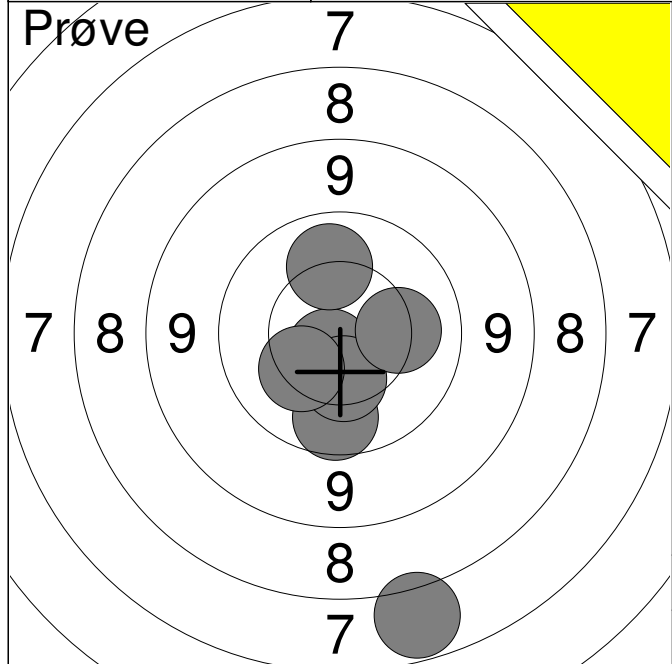

| | | |
|--------------|-------------|---|
| 1: | 9.9 | ↓ |
| 2: | 10.7x | ↙ |
| 3: | 7.0 | ↓ |
| 4: | 10.4 | ↓ |
| 5: | 10.3 | ↙ |
| 6: | 10.1 | ↑ |
| 7: | 10.2 | → |
| Serie | 66.0 | |
| Total | 0.0 | |

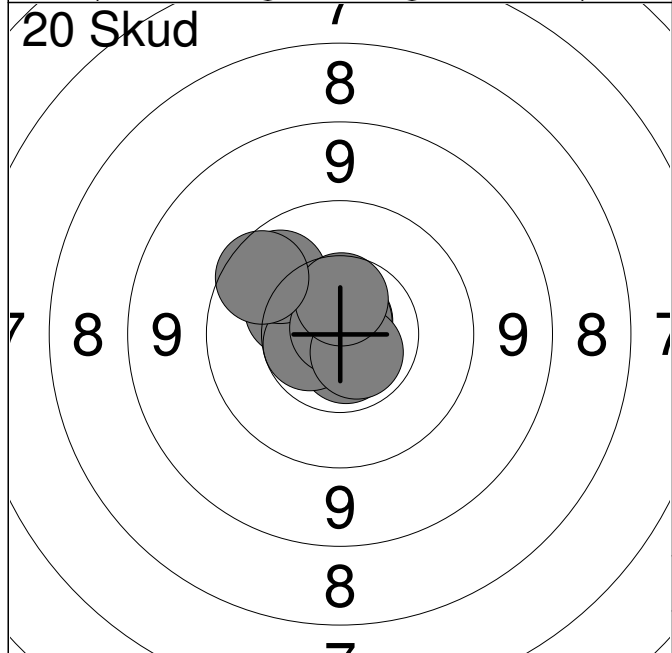

| | | |
|--------------|-------------|---|
| 1: | 10.8x | ↑ |
| 2: | 10.3 | ↙ |
| 3: | 10.7x | ↓ |
| 4: | 10.6 | ↙ |
| 5: | 10.8x | ↑ |
| 6: | 10.0 | ↗ |
| 7: | 10.9x | ↗ |
| 8: | 10.7x | ↘ |
| 9: | 10.5 | ↑ |
| 10: | 9.8 | ↖ |
| Serie | 99.0 | |
| Total | 99.0 | |

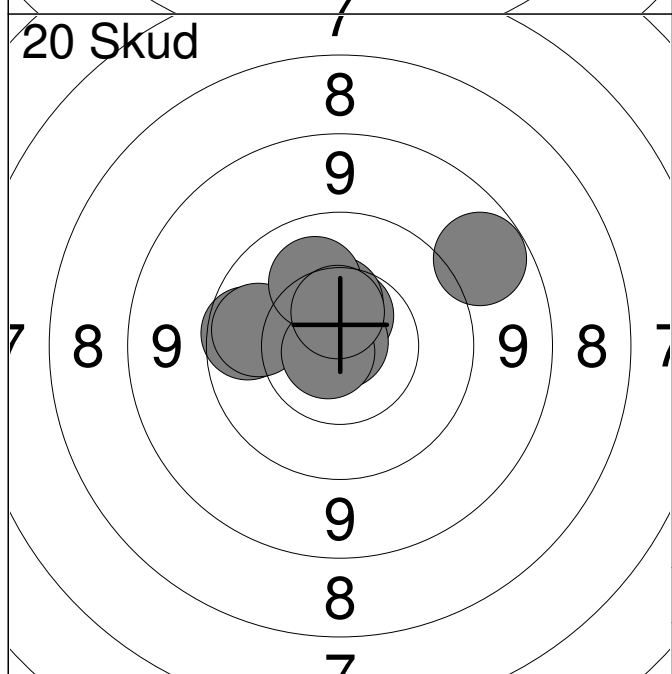

| | | |
|--------------|--------------|---|
| 11: | 10.7x | ↑ |
| 12: | 9.9 | ↙ |
| 13: | 10.6x | ↑ |
| 14: | 10.5 | ↑ |
| 15: | 10.0 | ↙ |
| 16: | 10.2 | ↗ |
| 17: | 10.9x | ↗ |
| 18: | 10.8x | ↙ |
| 19: | 9.0 | ↗ |
| 20: | 10.6 | ↑ |
| Serie | 98.0 | |
| Total | 197.0 | |

| | | | |
|-------------------|-------------------|------------------------------|--|
| Hold 24 | Skive 2 | Tobias Engberg Hansen | |
|-------------------|-------------------|------------------------------|--|

| | | | |
|-----|--------------------------|----|--|
| 15m | Løgstør Sportsskytteklub | J1 | |
|-----|--------------------------|----|--|

| | | | |
|--|---------------------------------|---------------------|--|
| | 15 meter riffelstævne oktober 2 | Aalborg Skyttekreds | |
|--|---------------------------------|---------------------|--|

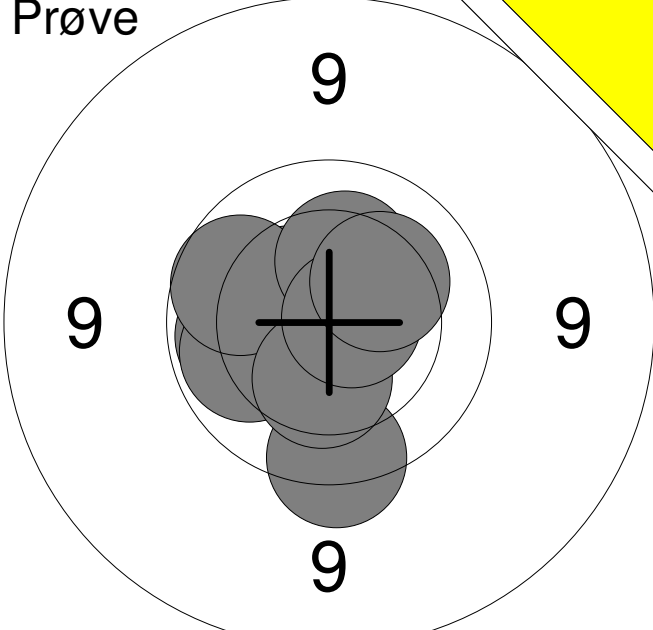
| | | | |
|--|--------------|------------|-------------|
| Prøve  | 1: | 9.7 | ↓ |
| | 2: | 10.0 | ← |
| | 3: | 10.5 | ↗ |
| | 4: | 10.0 | ← |
| | 5: | 9.9 | ↖ |
| | 6: | 10.3 | ↓ |
| | 7: | 10.3 | ↑ |
| | 8: | 10.7x | → |
| | 9: | 10.2 | ↗ |
| | Serie | | 88.0 |
| Total | | 0.0 | |

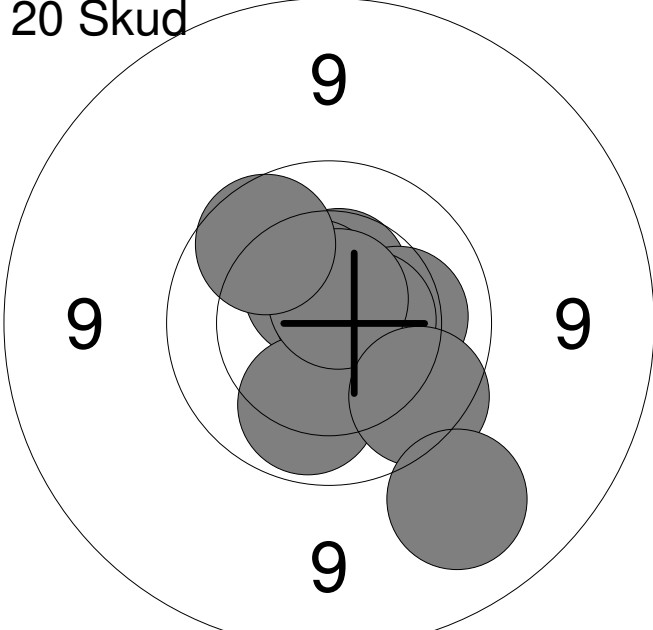
| | | | |
|---|-----|-------------|---|
| 20 Skud  | 1: | 10.5 | ↑ |
| | 2: | 10.2 | → |
| | 3: | 10.5x | ↗ |
| | 4: | 10.7x | ↗ |
| | 5: | 10.6x | → |
| | 6: | 10.0 | ↓ |
| | 7: | 10.7x | ↑ |
| | 8: | 9.8 | ↘ |
| | 9: | 9.9 | ↗ |
| | 10: | 9.2 | ↓ |
| Serie | | 97.0 | |
| Total | | 97.0 | |

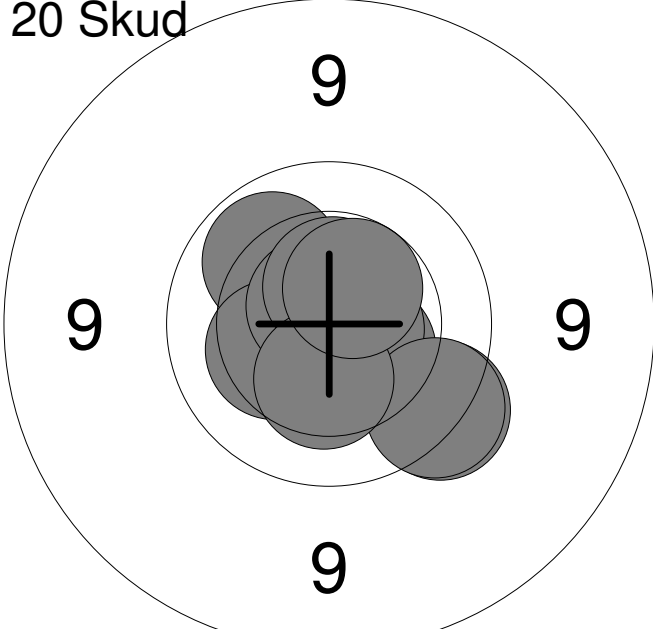
| | | | |
|--|-----|--------------|---|
| 20 Skud  | 11: | 9.7 | ↘ |
| | 12: | 10.5 | ↘ |
| | 13: | 10.0 | ↗ |
| | 14: | 10.3 | ← |
| | 15: | 10.7x | ↗ |
| | 16: | 10.7x | → |
| | 17: | 10.5x | ↑ |
| | 18: | 9.7 | ↘ |
| | 19: | 10.4 | ↓ |
| | 20: | 10.5x | ↗ |
| Serie | | 98.0 | |
| Total | | 195.0 | |

| | | |
|-------------------|-------------------|------------------------|
| Hold 24 | Skive 3 | Magnus Sørensen |
|-------------------|-------------------|------------------------|

| | | |
|-----|--------------------------|-----|
| 15m | Løgstør Sportsskytteklub | BK2 |
|-----|--------------------------|-----|

| | | |
|--|---------------------------------|---------------------|
| | 15 meter riffelstævne oktober 2 | Aalborg Skyttekreds |
|--|---------------------------------|---------------------|

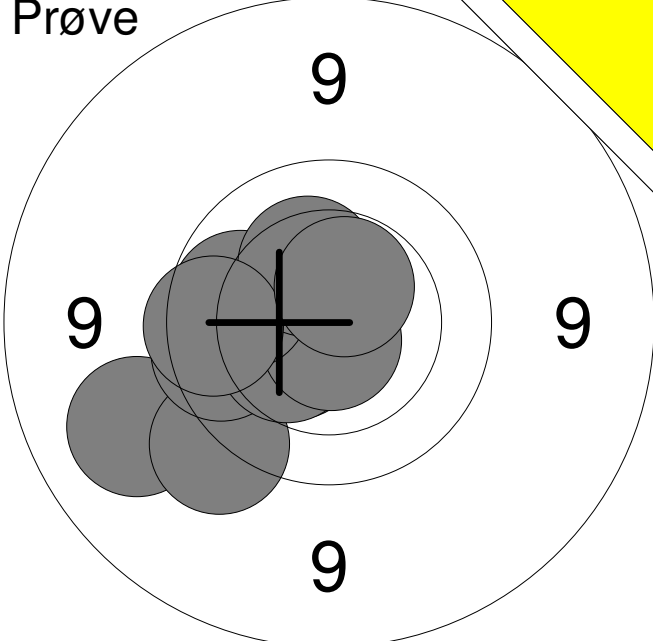
| | |
|--|--------------|
| Prøve  | 1: 10.5 ↙ |
| | 2: 9.2 ↙ |
| | 3: 9.5 ↙ |
| | 4: 9.8 ↙ |
| | 5: 10.4 ↙ |
| | 6: 10.8x ↓ |
| | 7: 10.0 ↙ |
| | 8: 10.3 ↑ |
| | 9: 9.8 ↙ |
| | 10: 10.5x ↑ |
| | Serie |
| Total | 0.0 |

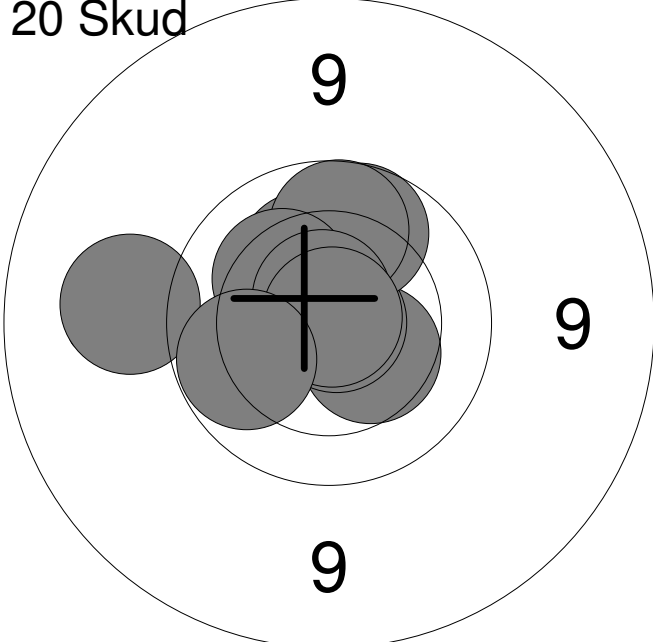
| | |
|---|--------------|
| 20 Skud  | 1: 10.4 ↘ |
| | 2: 10.9x → |
| | 3: 10.2 ↑ |
| | 4: 9.9 ↑ |
| | 5: 9.9 ↑ |
| | 6: 10.3 ↘ |
| | 7: 10.7x ↑ |
| | 8: 10.9x ↑ |
| | 9: 9.3 ↙ |
| | 10: 10.0 ↙ |
| | Serie |
| Total | 97.0 |

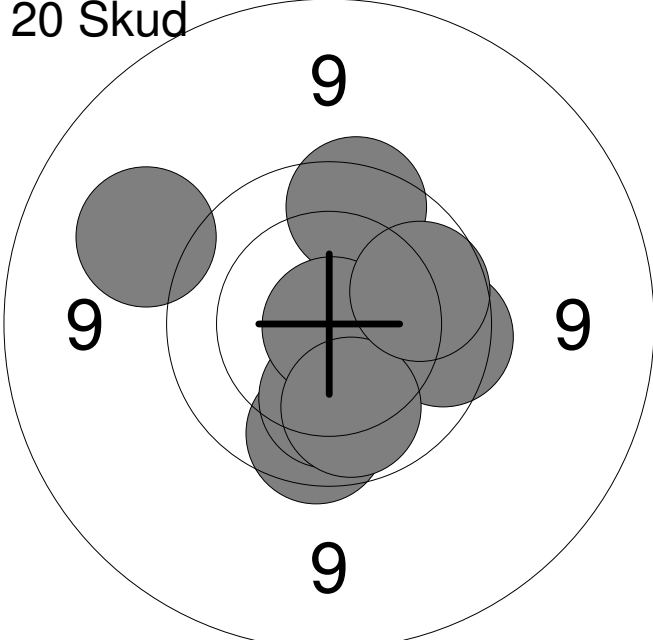
| | |
|--|--------------|
| 20 Skud  | 11: 9.8 ↓ |
| | 12: 9.8 ↑ |
| | 13: 10.5 ↓ |
| | 14: 10.1 ↓ |
| | 15: 10.4 ↓ |
| | 16: 9.8 → |
| | 17: 10.9x ↓ |
| | 18: 10.0 ↓ |
| | 19: 9.3 ↗ |
| | 20: 9.9 → |
| | Serie |
| Total | 192.0 |

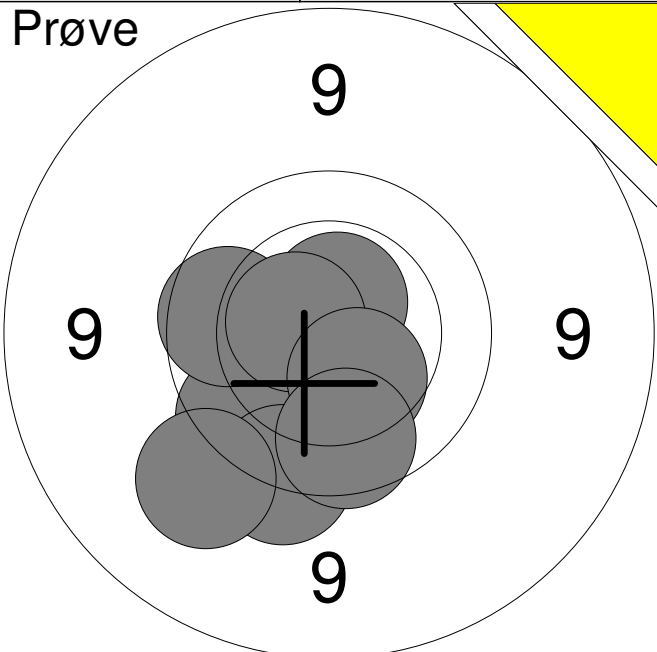
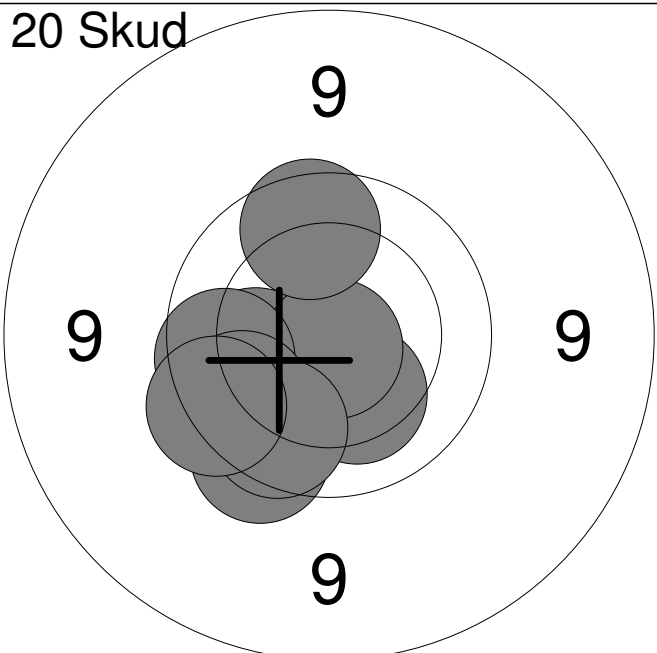
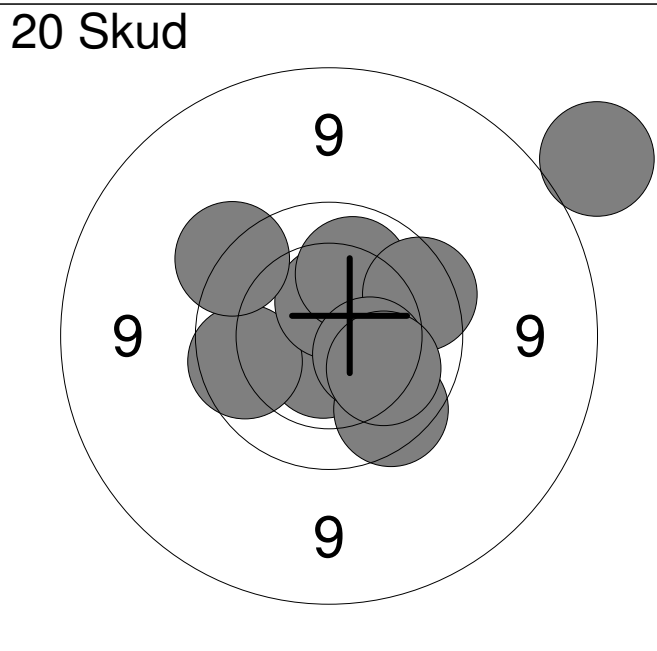
| Hold | Skive | Caroline Lykke Larsen | |
|---------|--|---|-------|
| 24 | 4 | | |
| 15m | Løgstør Sportsskytteklub | BK4 | |
| | 15 meter riffelstævne oktober 2 | Aalborg Skyttekreds | |
| Prøve |  | 1: 10.6x ↑ 2: 9.8 ↙ 3: 9.9 ← 4: 9.6 ↘ 5: 9.3 ↙ 6: 10.6x ← 7: 10.4 ↘ 8: 9.9 ↘ | |
| | | Serie | 75.0 |
| | | Total | 0.0 |
| 20 Skud |  | 1: 9.9 ↙ 2: 10.1 ← 3: 10.2 ↘ 4: 10.8x ↘ 5: 9.9 ← 6: 9.9 ↙ 7: 9.7 ↘ 8: 9.9 ↑ 9: 9.9 ↙ 10: 9.7 ↙ | |
| | | Serie | 93.0 |
| | | Total | 93.0 |
| 20 Skud |  | 11: 10.6x ↘ 12: 9.9 ← 13: 10.5x ↑ 14: 9.6 ↗ 15: 9.8 ↘ 16: 10.1 ↑ 17: 9.8 → 18: 8.4 ↗ 19: 10.4 ↘ 20: 10.1 ↘ | |
| | | Serie | 94.0 |
| | | Total | 187.0 |

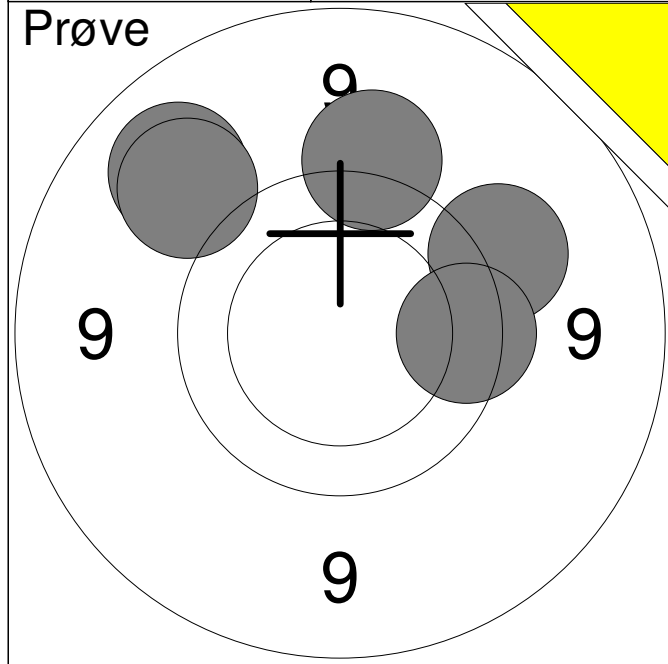

| | | |
|--------------|-----|-------------|
| 1: | 9.1 | ↗ |
| 2: | 9.4 | ↑ |
| 3: | 9.2 | ↗ |
| 4: | 9.4 | ↗ |
| 5: | 9.7 | → |
| Serie | | 45.0 |
| Total | | 0.0 |

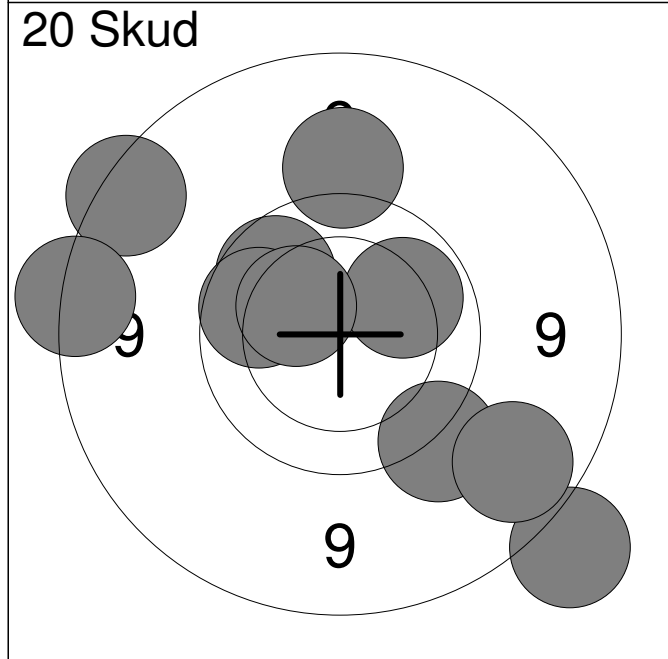

| | | |
|--------------|------|-------------|
| 1: | 8.8 | ↗ |
| 2: | 8.5 | ↘ |
| 3: | 9.9 | ↗ |
| 4: | 9.9 | ↖ |
| 5: | 8.7 | ↖ |
| 6: | 10.1 | ↗ |
| 7: | 10.3 | ↗ |
| 8: | 9.5 | ↘ |
| 9: | 9.3 | ↑ |
| 10: | 9.0 | ↘ |
| Serie | | 89.0 |
| Total | | 89.0 |

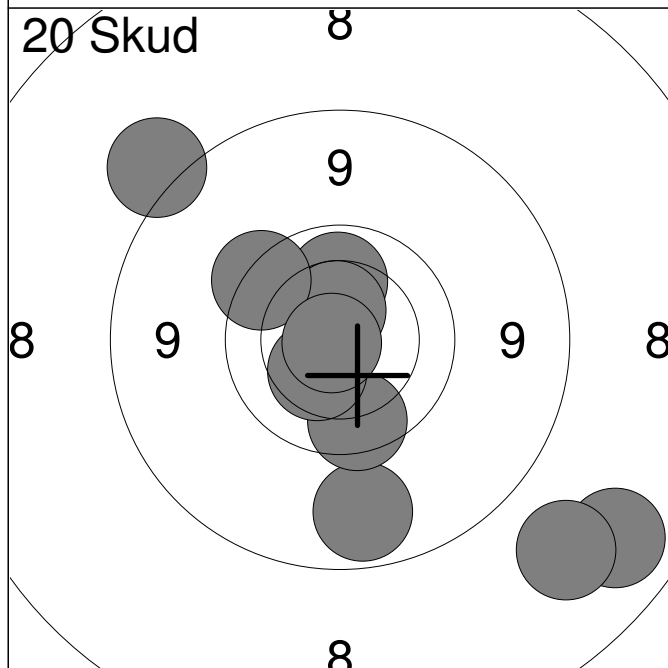

| | | |
|--------------|-------|--------------|
| 11: | 8.1 | ↘ |
| 12: | 10.1 | ↑ |
| 13: | 8.6 | ↗ |
| 14: | 9.0 | ↘ |
| 15: | 10.5x | ↑ |
| 16: | 8.2 | ↘ |
| 17: | 9.8 | ↘ |
| 18: | 10.4 | ↖ |
| 19: | 9.7 | ↗ |
| 20: | 10.8x | ↖ |
| Serie | | 91.0 |
| Total | | 180.0 |

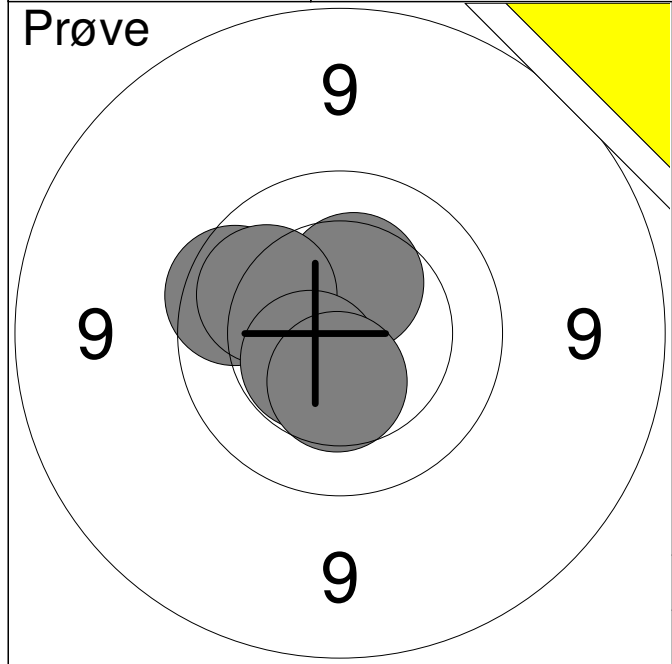

| | | |
|--------------|-------|-------------|
| 1: | 9.8 | ← |
| 2: | 10.4 | ↑ |
| 3: | 10.1 | ← |
| 4: | 10.5x | ↙ |
| 5: | 10.4 | ↓ |
| Serie | | 49.0 |
| Total | | 0.0 |

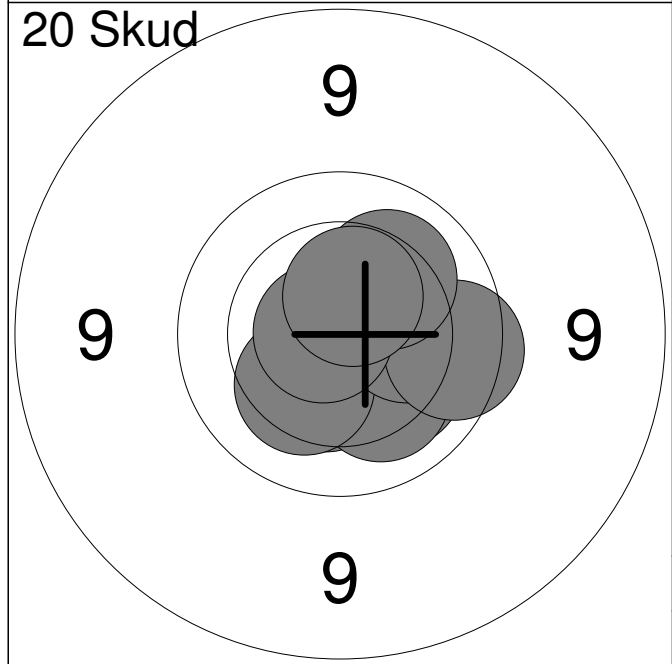

| | | |
|--------------|-------|-------------|
| 1: | 10.3 | → |
| 2: | 10.2 | ↘ |
| 3: | 10.4 | ↓ |
| 4: | 10.2 | ↘ |
| 5: | 10.3 | ↙ |
| 6: | 10.2 | → |
| 7: | 9.8 | → |
| 8: | 10.2 | ↗ |
| 9: | 10.8x | ← |
| 10: | 10.5x | ↑ |
| Serie | | 99.0 |
| Total | | 99.0 |

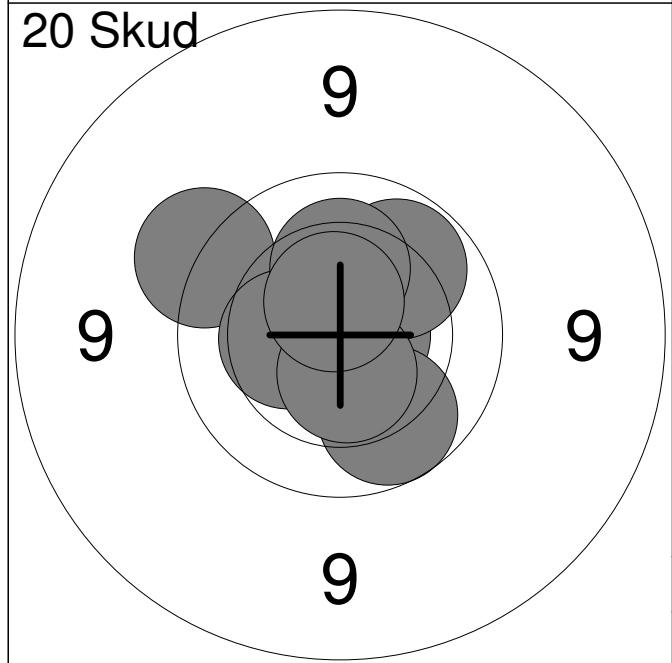

| | | |
|--------------|-------|--------------|
| 11: | 10.5 | ↖ |
| 12: | 10.6x | ↑ |
| 13: | 10.7x | → |
| 14: | 9.9 | ↘ |
| 15: | 9.6 | ↗ |
| 16: | 10.4 | ← |
| 17: | 10.0 | ↗ |
| 18: | 10.5x | ↓ |
| 19: | 10.2 | ↑ |
| 20: | 10.6x | ↑ |
| Serie | | 98.0 |
| Total | | 197.0 |

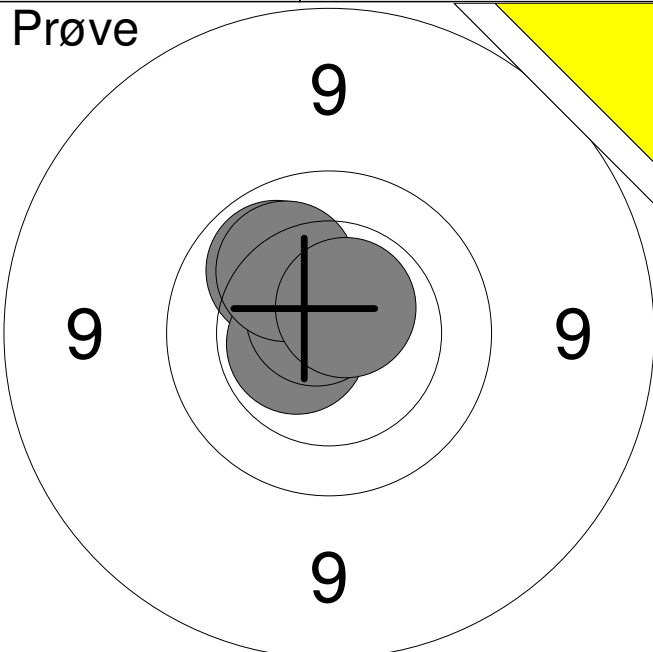
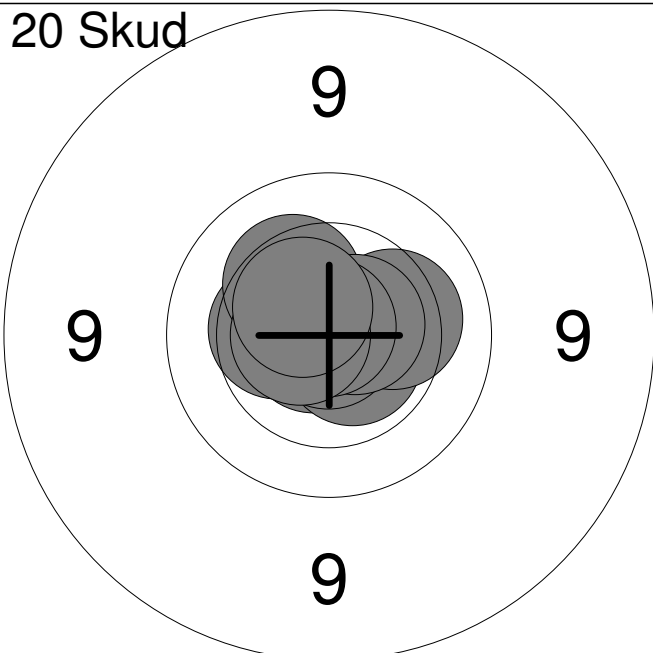
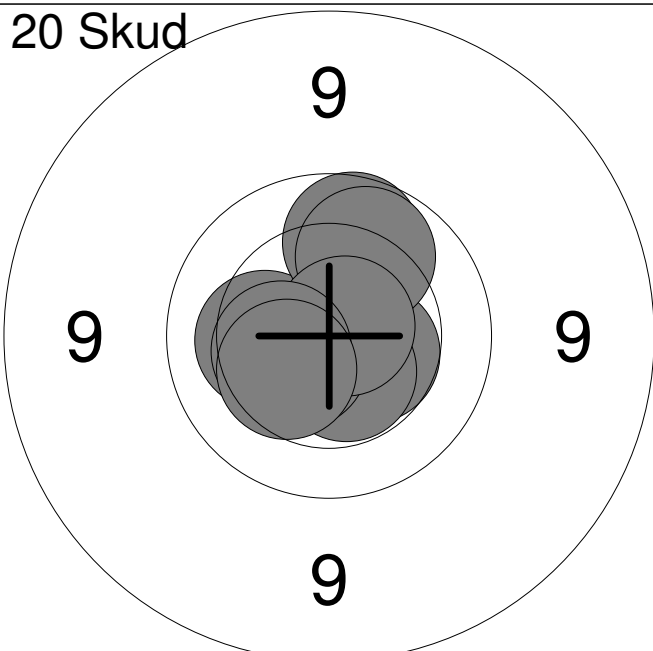
| Hold | Skive | Jørn Kristensen | |
|---------|--|---------------------|--------------|
| 24 | 8 | | |
| 15m | Midtdjurs Skytteforening | | MÅ1 |
| | 15 meter riffelstævne oktober 2 | Aalborg Skyttekreds | |
| Prøve |  | 1: 10.1 | ↗ |
| | | 2: 10.6x | ↖ |
| | | 3: 10.7x | ↗ |
| | | 4: 10.1 | ↗ |
| | | 5: 10.6x | ↗ |
| | | Serie | 50.0 |
| | | Total | 0.0 |
| 20 Skud |  | 1: 10.4 | ↖ |
| | | 2: 10.8x | ↖ |
| | | 3: 10.6x | ↘ |
| | | 4: 10.2 | ↗ |
| | | 5: 10.3 | ↗ |
| | | 6: 10.9x | ↘ |
| | | 7: 10.6x | ↗ |
| | | 8: 10.9x | ↗ |
| | | 9: 10.6x | ↖ |
| | | 10: 10.5x | ↗ |
| | | Serie | 100.0 |
| | | Total | 100.0 |
| 20 Skud |  | 11: 10.8x | ↘ |
| | | 12: 10.5 | ↘ |
| | | 13: 10.5x | ↘ |
| | | 14: 10.3 | ↖ |
| | | 15: 9.9 | ↗ |
| | | 16: 10.0 | ↗ |
| | | 17: 10.5x | ↖ |
| | | 18: 10.7x | ↗ |
| | | 19: 10.4 | ↖ |
| | | 20: 10.4 | ↖ |
| | | Serie | 99.0 |
| | | Total | 199.0 |

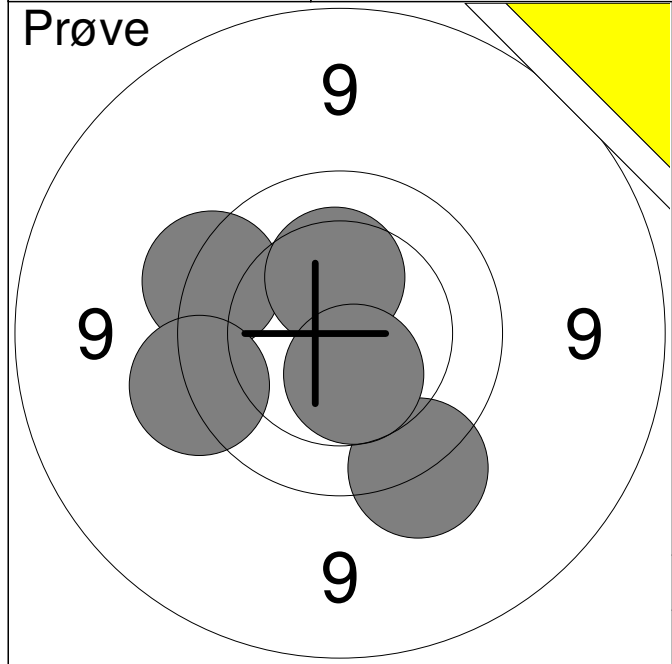

| | | |
|--------------|------|-------------|
| 1: | 9.7 | ↗ |
| 2: | 9.6 | ↖ |
| 3: | 10.3 | ↑ |
| 4: | 9.6 | ↓ |
| 5: | 10.5 | ↓ |
| Serie | | 47.0 |
| Total | | 0.0 |

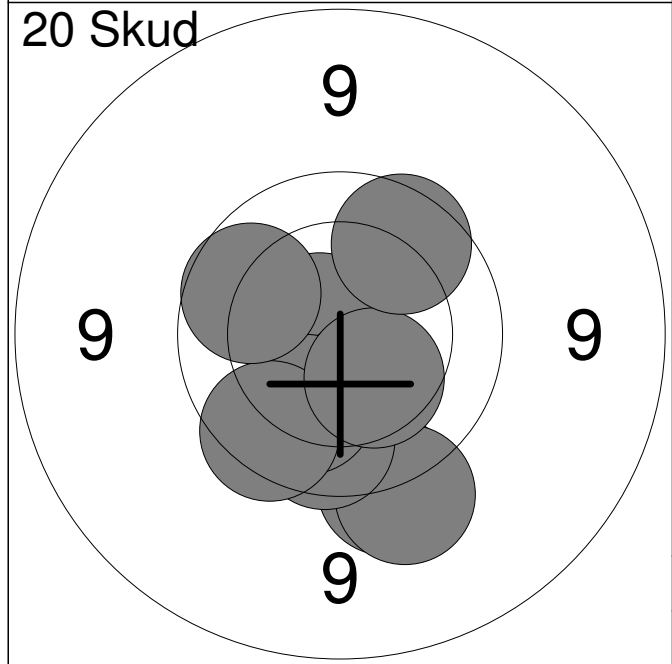

| | | |
|--------------|-------|-------------|
| 1: | 10.7x | ↗ |
| 2: | 10.3 | ↓ |
| 3: | 9.5 | ↓ |
| 4: | 9.5 | ↓ |
| 5: | 9.9 | ↓ |
| 6: | 10.1 | ↓ |
| 7: | 9.8 | ↖ |
| 8: | 9.9 | ↗ |
| 9: | 10.4 | ↓ |
| 10: | 9.8 | ↗ |
| Serie | | 94.0 |
| Total | | 94.0 |

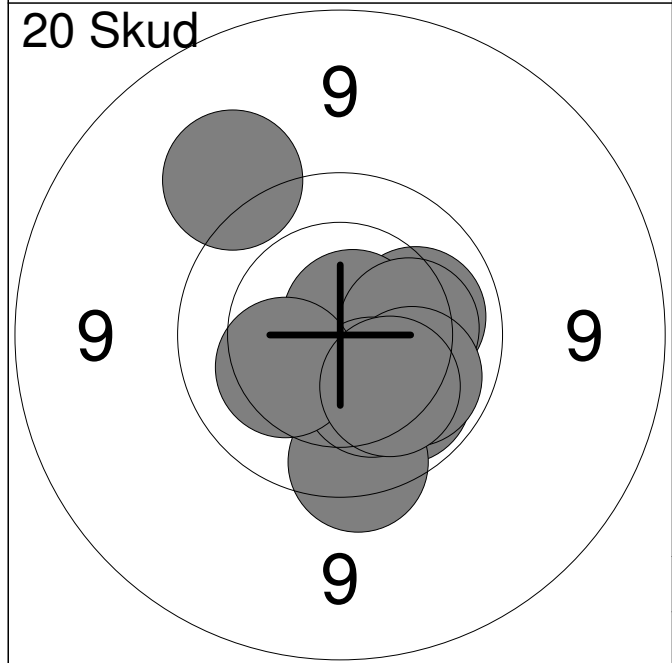

| | | |
|--------------|-------|--------------|
| 11: | 10.1 | → |
| 12: | 10.7x | ↗ |
| 13: | 10.2 | → |
| 14: | 10.0 | ↓ |
| 15: | 10.1 | ↓ |
| 16: | 9.4 | ↗ |
| 17: | 9.7 | ↓ |
| 18: | 10.3 | ↓ |
| 19: | 10.3 | ↖ |
| 20: | 10.2 | ↓ |
| Serie | | 98.0 |
| Total | | 192.0 |

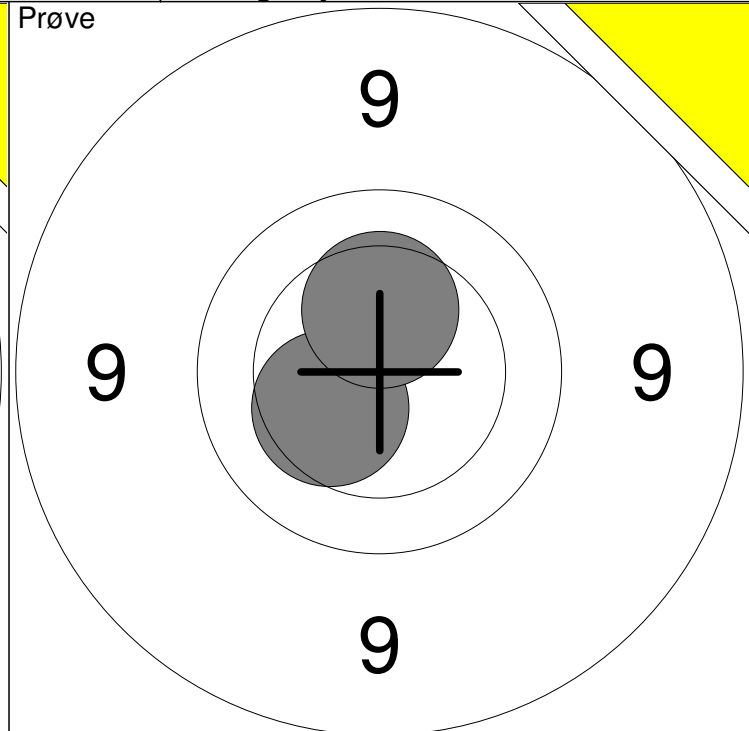
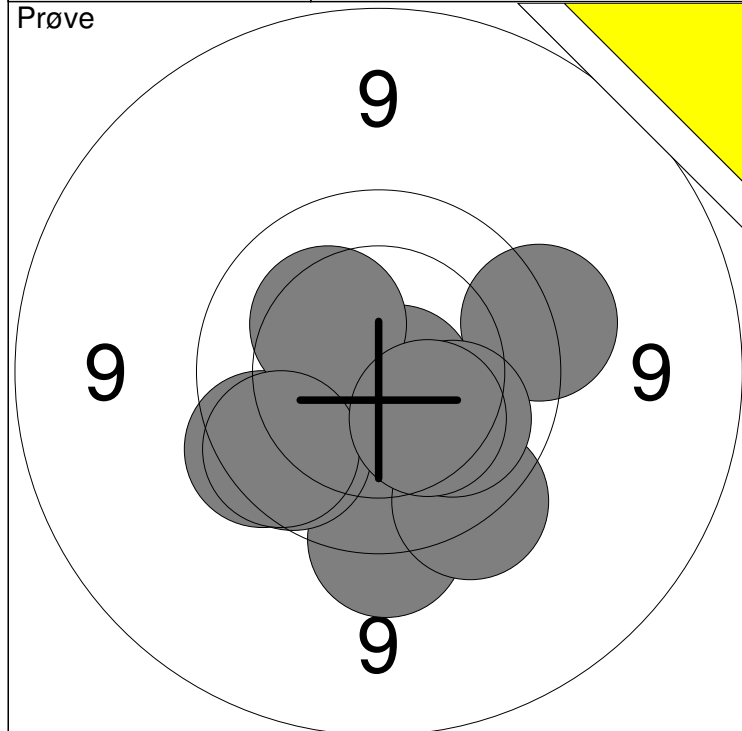

| | | | |
|------------|------------|-------|----|
| 1: 9.6 ↓ | 6: 9.9 ↙ | Serie | 94 |
| 2: 9.6 → | 7: 10.3 ↗ | | |
| 3: 9.8 ↙ | 8: 9.8 ↙ | Total | 0 |
| 4: 9.6 ↓ | 9: 10.1 ↘ | | |
| 5: 10.7x ↘ | 10: 10.3 ↘ | | |

| | | |
|------------|-------|----|
| 11: 10.4 ↙ | Serie | 20 |
| 12: 10.3 ↑ | | |
| Total | | 0 |

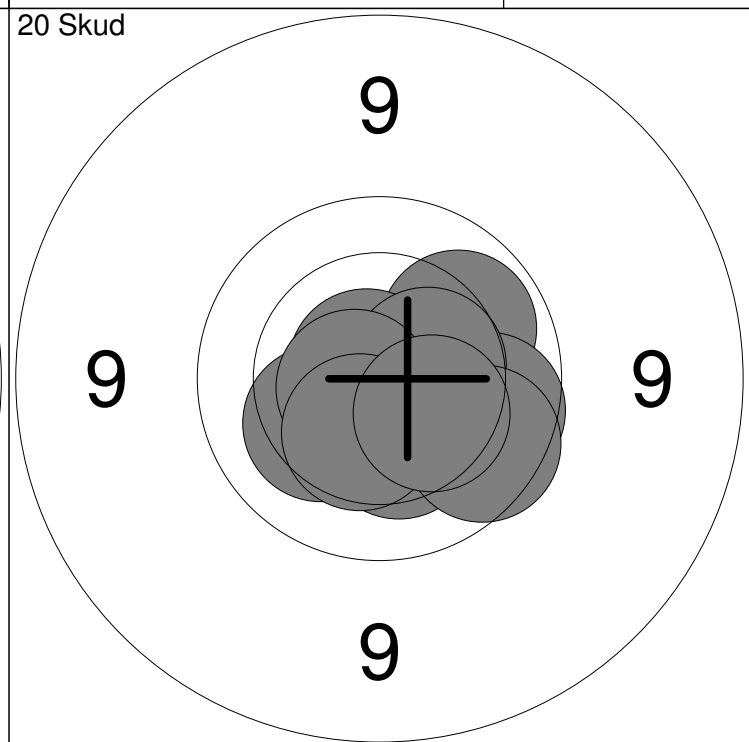
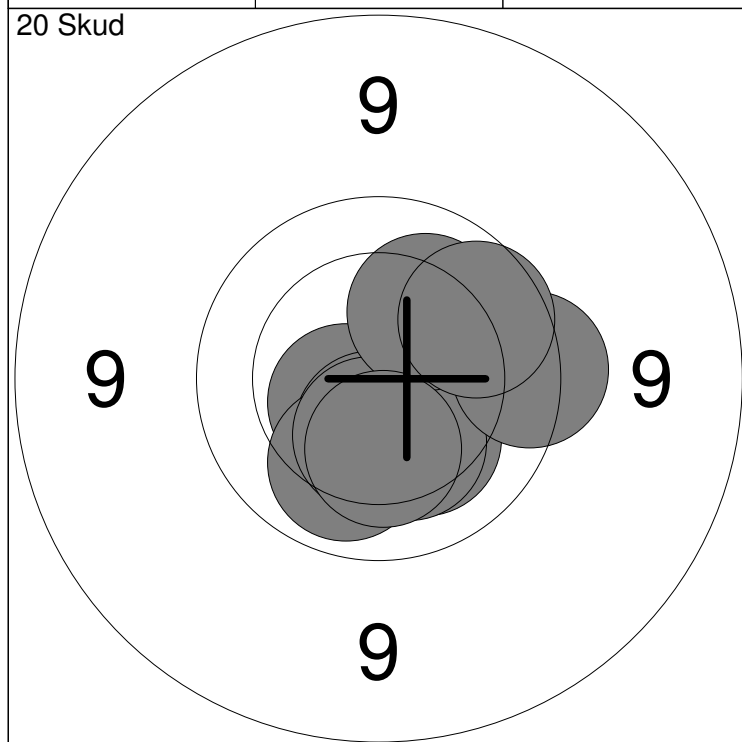

| | | | |
|------------|-----------|-------|----|
| 1: 10.6x ↙ | 6: 10.3 ↓ | Serie | 98 |
| 2: 10.5 ↓ | 7: 10.2 ↗ | | |
| 3: 10.1 ↓ | 8: 9.7 → | Total | 98 |
| 4: 10.4 ↓ | 9: 10.3 ↓ | | |
| 5: 10.2 ↓ | 10: 9.9 ↗ | | |

| | | | |
|-------------|-------------|-------|-----|
| 11: 10.0 ↗ | 16: 10.3 ↓ | Serie | 98 |
| 12: 9.9 → | 17: 10.7x ↙ | | |
| 13: 10.2 ↙ | 18: 9.8 ↘ | Total | 196 |
| 14: 10.8x ↙ | 19: 10.4 ↓ | | |
| 15: 10.5 → | 20: 10.3 ↓ | | |

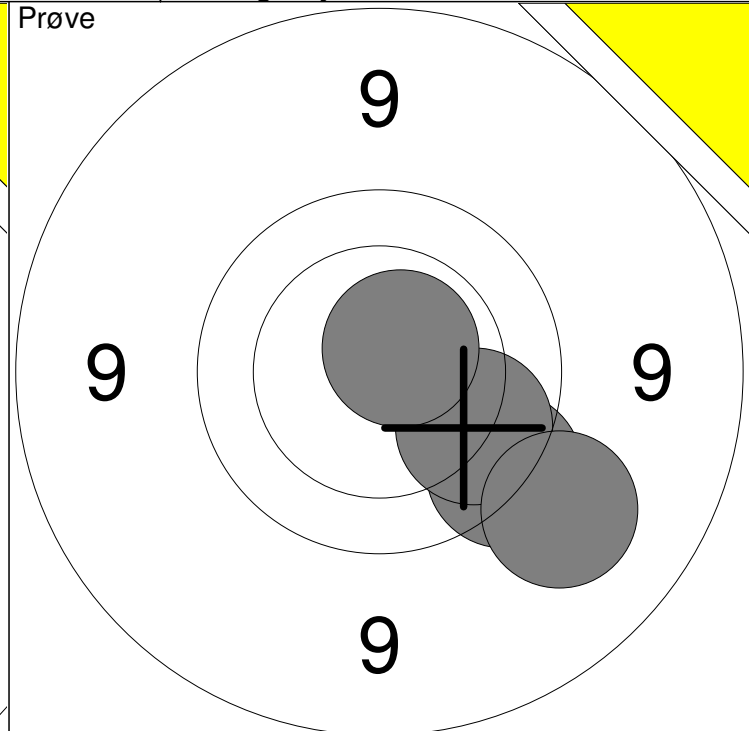
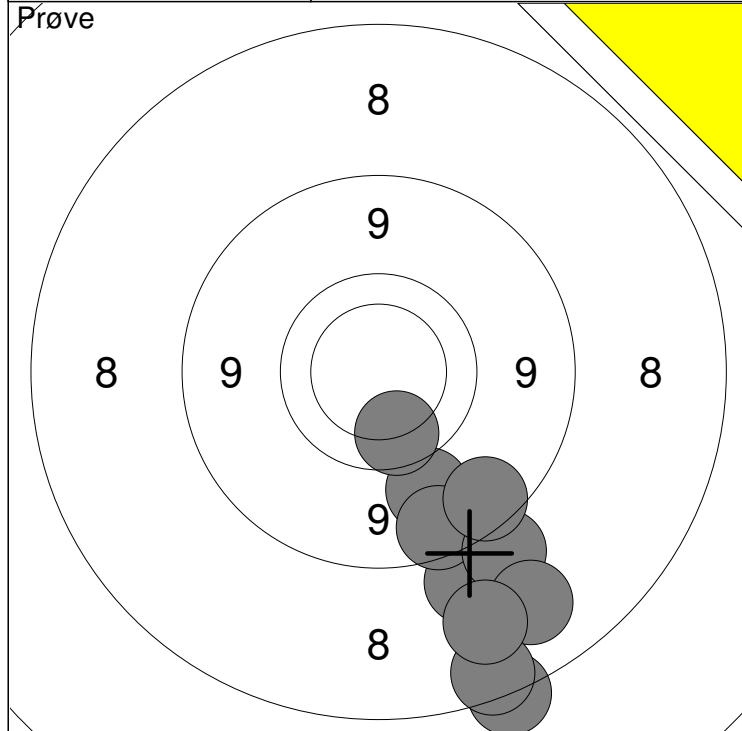

| | | | |
|----------|-----------|--------------|----|
| 1: 8.5 ↓ | 6: 7.7 ↓ | Serie | 80 |
| 2: 9.2 ↓ | 7: 7.8 ↓ | | |
| 3: 8.9 ↓ | 8: 8.2 ↓ | Total | 0 |
| 4: 8.5 ↓ | 9: 8.9 ↓ | | |
| 5: 8.1 ↓ | 10: 9.9 ↓ | | |
| | | | |

| | | |
|-------------|--------------|----|
| 11: 9.7 ↓ | Serie | 37 |
| 12: 9.9 ↓ | | |
| 13: 9.3 ↓ | Total | 0 |
| 14: 10.6x ↗ | | |
| | | |

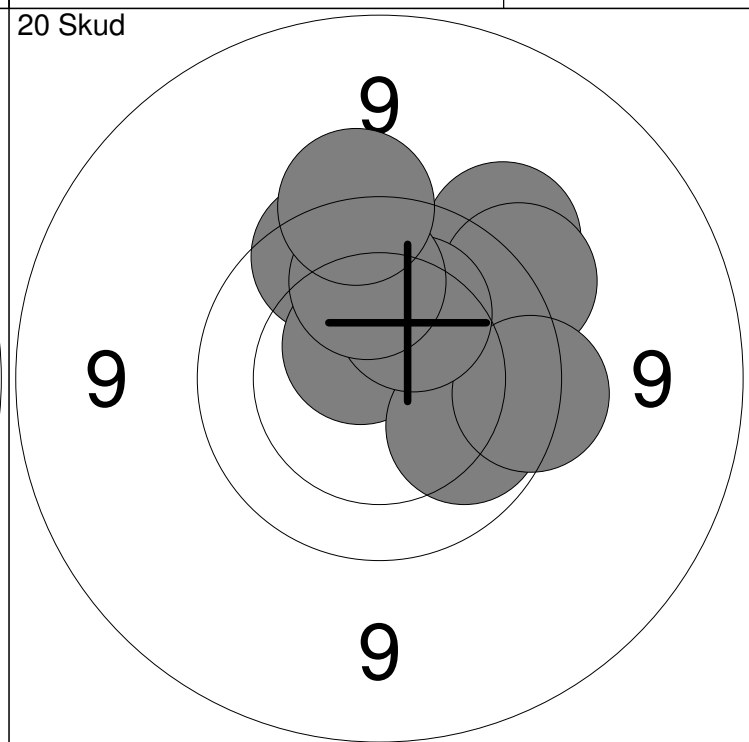
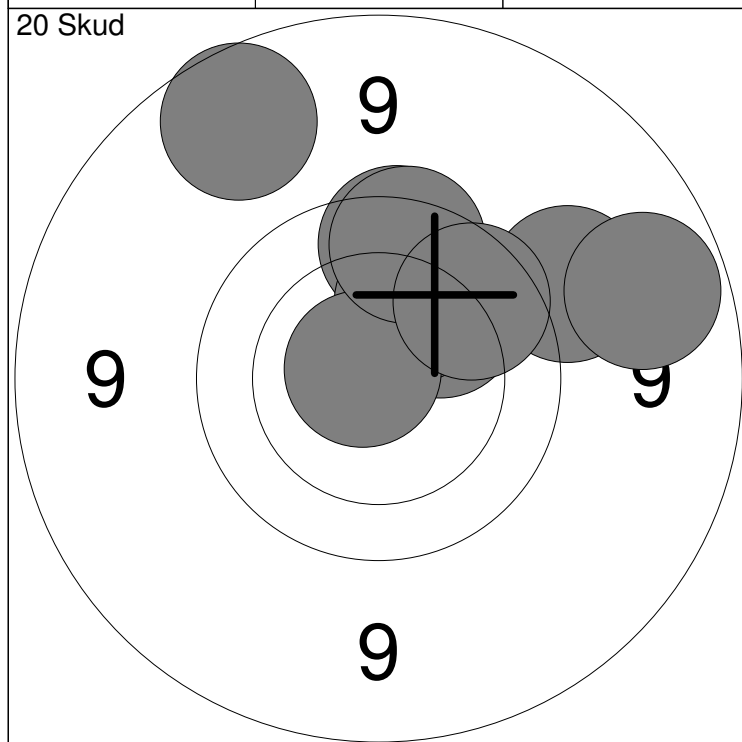

| | | | |
|-----------|------------|--------------|----|
| 1: 8.9 ↗ | 6: 10.2 ↗ | Serie | 92 |
| 2: 9.4 ↗ | 7: 10.8x ↖ | | |
| 3: 9.9 ↗ | 8: 9.8 ↗ | Total | 92 |
| 4: 10.1 ↗ | 9: 9.0 → | | |
| 5: 9.8 ↗ | 10: 9.9 ↗ | | |
| | | | |

| | | | |
|-------------|------------|--------------|-----|
| 11: 9.8 ↗ | 16: 10.0 ↓ | Serie | 94 |
| 12: 9.8 ↗ | 17: 9.7 → | | |
| 13: 9.5 ↗ | 18: 10.2 ↗ | Total | 186 |
| 14: 10.6x ↗ | 19: 10.0 ↗ | | |
| 15: 9.6 ↗ | 20: 9.6 ↗ | | |
| | | | |

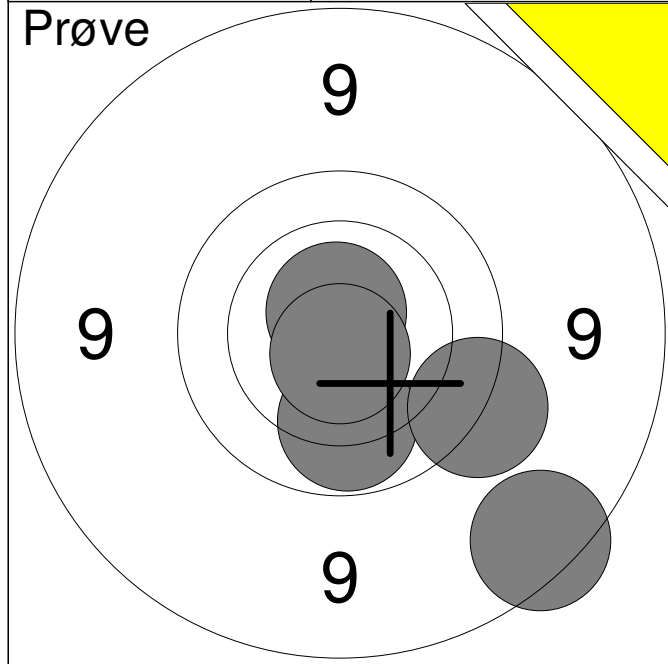

| | | |
|--------------|-------|-------------|
| 1: | 8.8 | ↘ |
| 2: | 10.7x | ↑ |
| 3: | 10.0 | ↘ |
| 4: | 9.6 | ↘ |
| 5: | 10.7x | ↓ |
| Serie | | 47.0 |
| Total | | 0.0 |

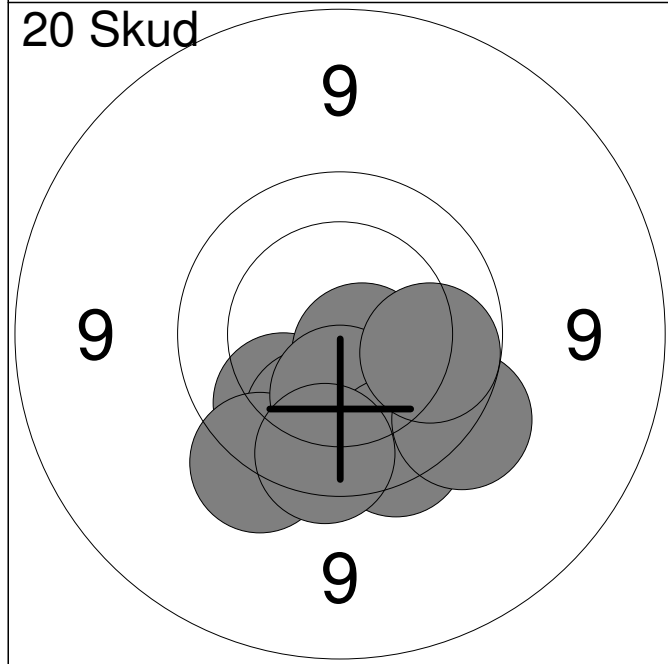

| | | |
|--------------|-------|-------------|
| 1: | 10.0 | ↙ |
| 2: | 10.6x | ↘ |
| 3: | 9.8 | ↘ |
| 4: | 10.0 | ↘ |
| 5: | 9.6 | ↙ |
| 6: | 10.3 | ↘ |
| 7: | 9.7 | ↘ |
| 8: | 9.8 | ↘ |
| 9: | 9.6 | ↘ |
| 10: | 10.0 | → |
| Serie | | 95.0 |
| Total | | 95.0 |

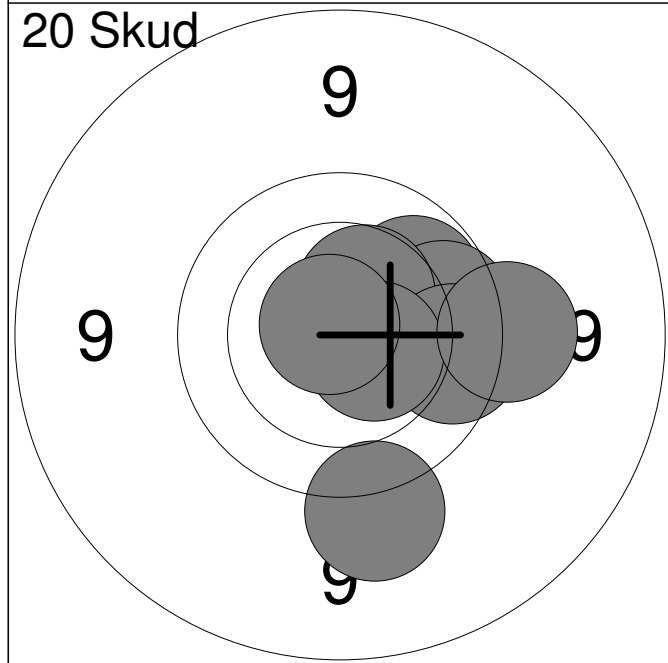

| | | |
|--------------|-------|--------------|
| 11: | 10.4 | → |
| 12: | 10.0 | ↗ |
| 13: | 9.9 | → |
| 14: | 10.8x | ↗ |
| 15: | 10.4 | ↗ |
| 16: | 9.8 | → |
| 17: | 10.5x | ↘ |
| 18: | 10.8x | ↗ |
| 19: | 9.5 | → |
| 20: | 9.4 | ↓ |
| Serie | | 96.0 |
| Total | | 191.0 |

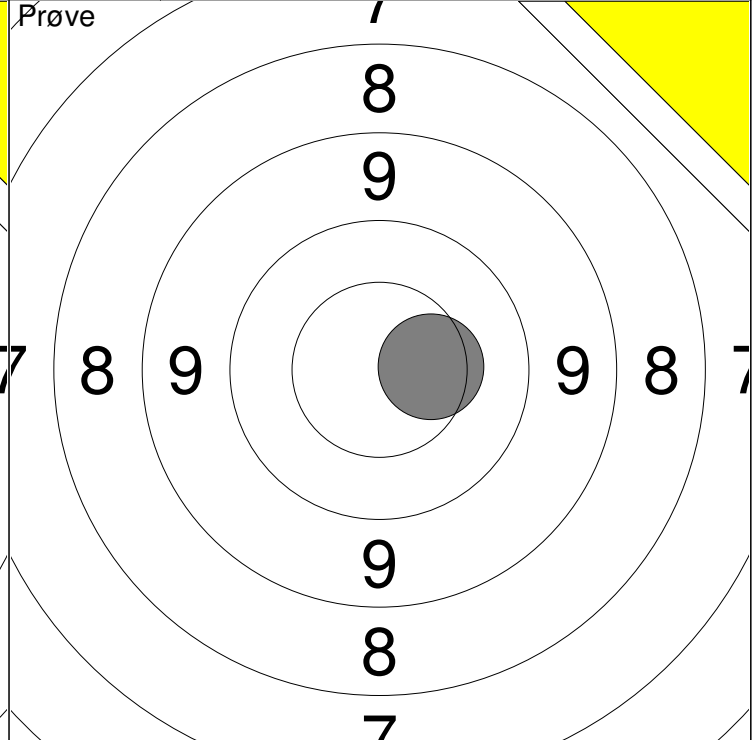
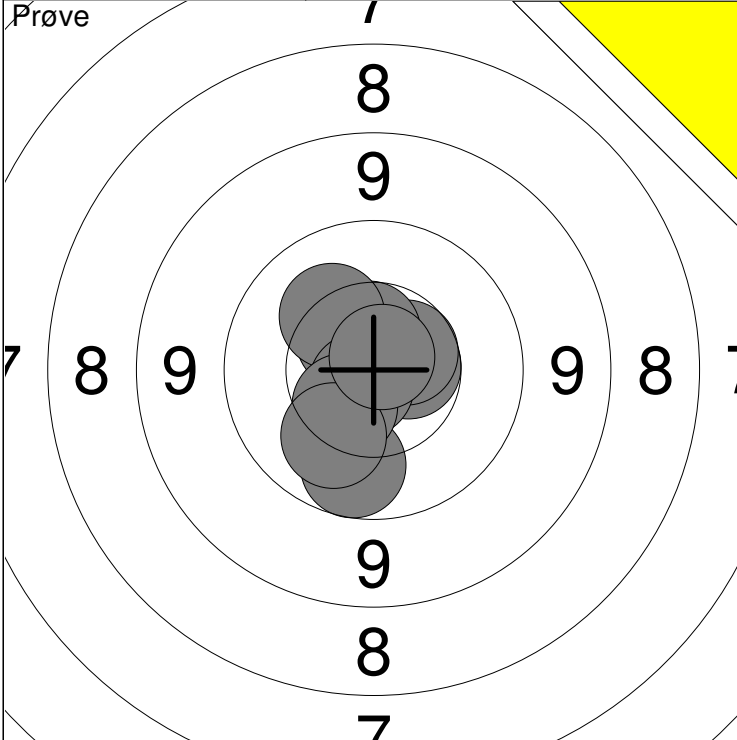

| | | | |
|------------|-------------|-------------|--|
| 1: 10.5 ↗ | 6: 10.8x ↘ | Serie 99 | |
| 2: 10.6x → | 7: 9.9 ↓ | | |
| 3: 10.6 ↗ | 8: 10.5 ↘ | Total 0 | |
| 4: 10.6 ↑ | 9: 10.2 ↘ | | |
| 5: 10.2 ↖ | 10: 10.8x ↗ | | |

| | | | |
|------------|--|-------------|--|
| 11: 10.4 → | | Serie 10 | |
| | | Total 0 | |

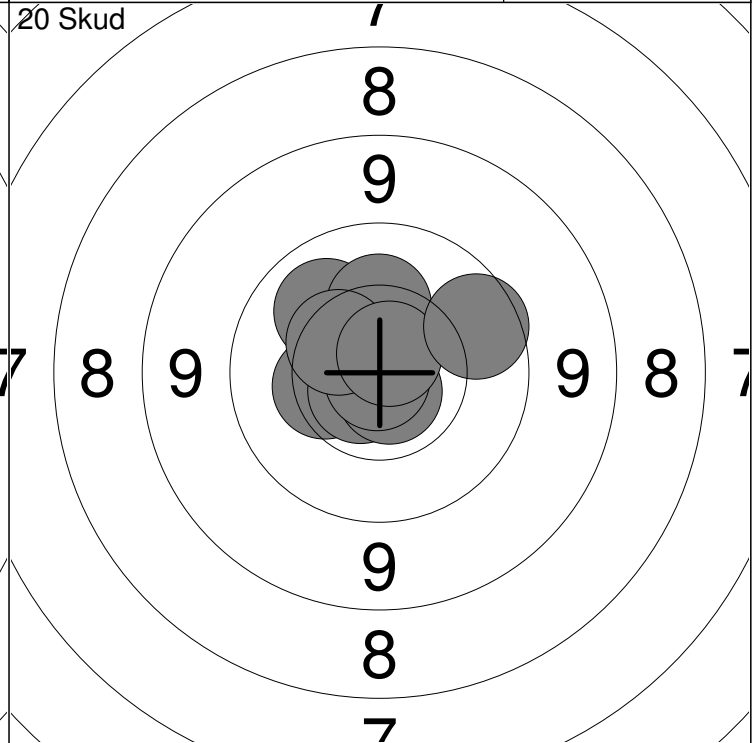
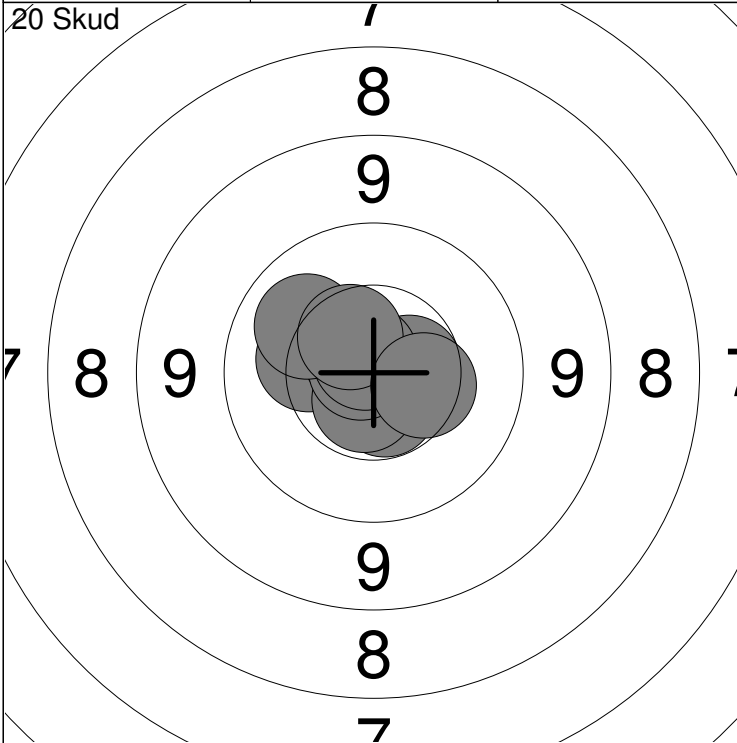

| | | | |
|------------|------------|--------------|--|
| 1: 10.3 ← | 6: 10.8x ↖ | Serie 100 | |
| 2: 10.7x ↗ | 7: 10.1 ↗ | | |
| 3: 10.6x ↓ | 8: 10.8x ↗ | Total 100 | |
| 4: 10.6 → | 9: 10.5 ↗ | | |
| 5: 10.7x ↓ | 10: 10.4 ↘ | | |

| | | | |
|-------------|-------------|--------------|--|
| 11: 10.4 ← | 16: 10.1 ↖ | Serie 99 | |
| 12: 10.7x ↖ | 17: 10.3 ↑ | | |
| 13: 10.7x ↘ | 18: 10.4 ↖ | Total 199 | |
| 14: 10.7x ↓ | 19: 10.7x ↗ | | |
| 15: 10.9x ↓ | 20: 9.8 ↗ | | |

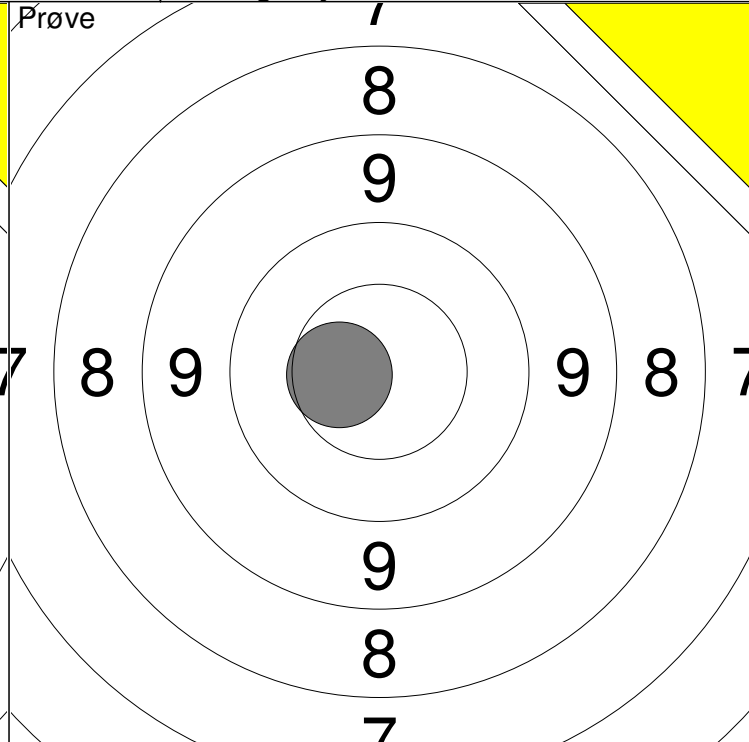
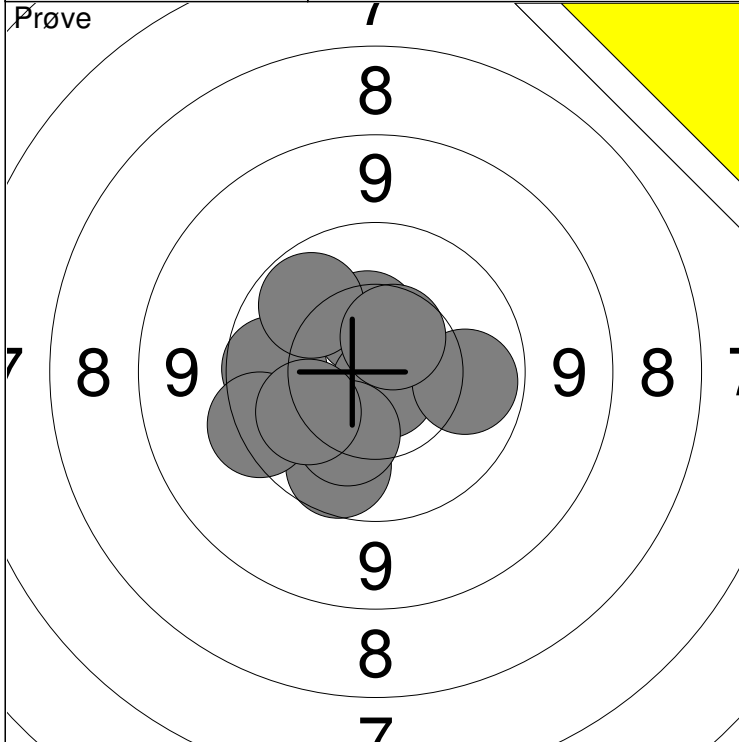

| | | |
|------------|------------|----------|
| 1: 10.4 ↑ | 6: 10.0 → | Serie 97 |
| 2: 9.9 ← | 7: 9.6 ← | |
| 3: 9.9 ↓ | 8: 10.1 ← | Total 0 |
| 4: 10.8x ↓ | 9: 10.0 ↖ | |
| 5: 10.3 ↓ | 10: 10.5 ↗ | |
| | | |

| | |
|------------|----------|
| 11: 10.5 ← | Serie 10 |
| | Total 0 |

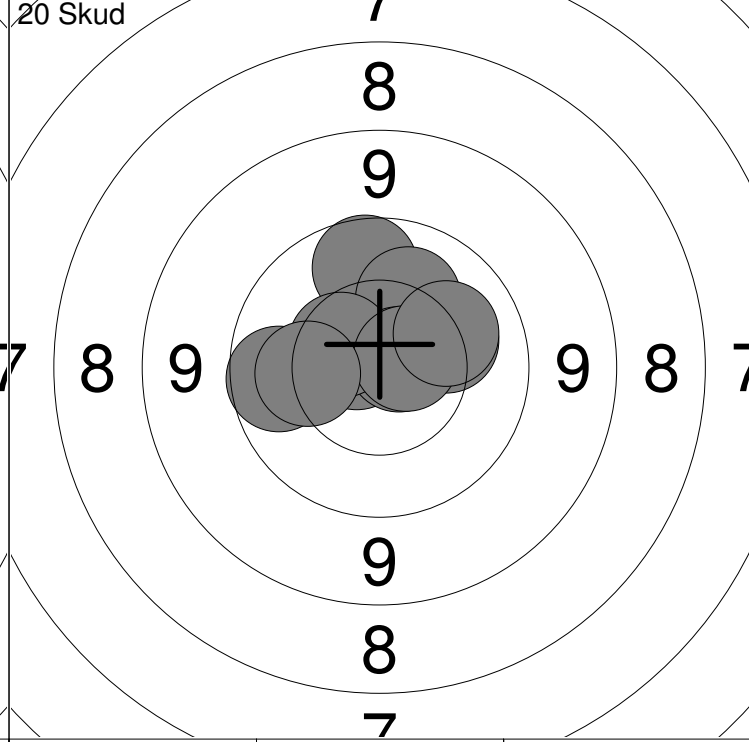
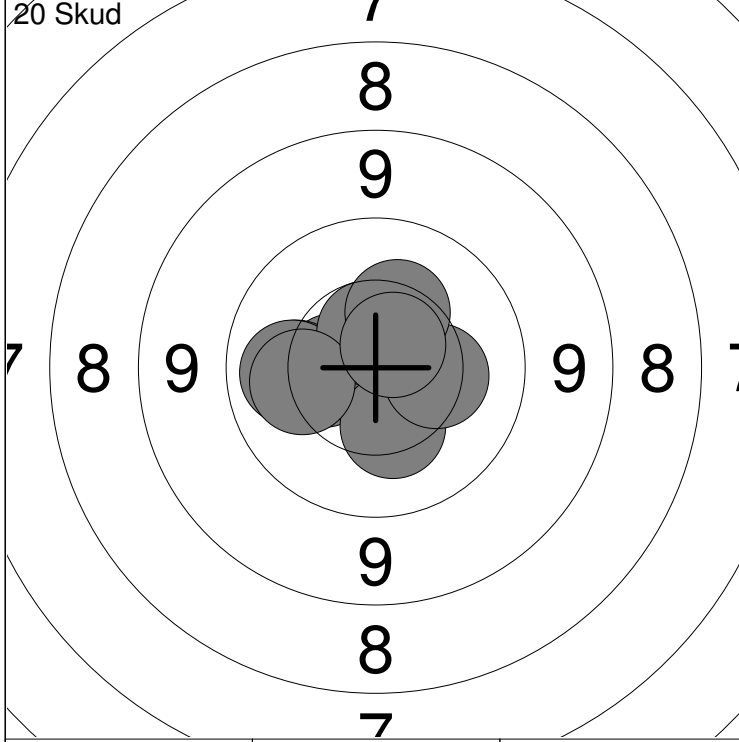

| | | |
|-----------|-------------|-----------|
| 1: 10.4 ← | 6: 10.3 ↓ | Serie 100 |
| 2: 10.5 ← | 7: 10.3 → | |
| 3: 10.1 ← | 8: 10.3 ↑ | Total 100 |
| 4: 10.1 ← | 9: 10.2 ← | |
| 5: 10.6 ↑ | 10: 10.7x ↗ | |
| | | |

| | | |
|-------------|-------------|-----------|
| 11: 9.9 ↑ | 16: 10.2 → | Serie 98 |
| 12: 10.7x ← | 17: 10.7x → | |
| 13: 10.2 ↑ | 18: 9.9 ← | Total 198 |
| 14: 10.7x → | 19: 10.2 ← | |
| 15: 10.5 ← | 20: 10.2 → | |
| | | |

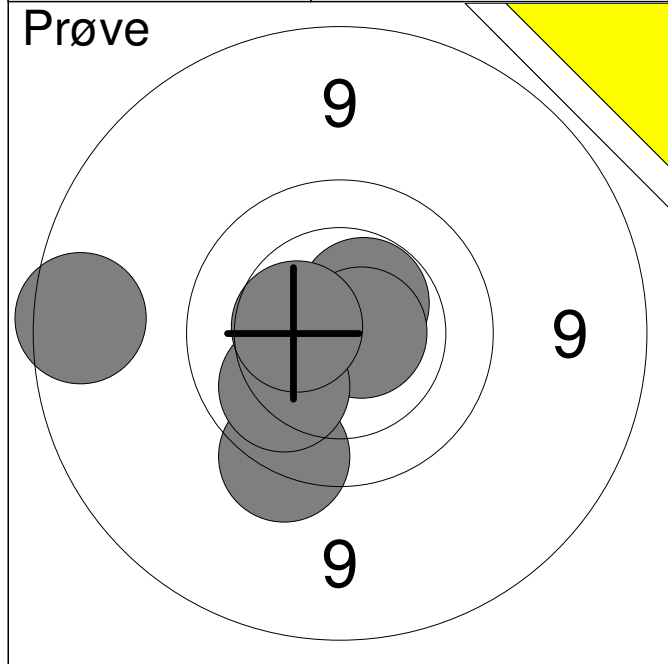

| | | |
|----|-------|---|
| 1: | 8.9 | ← |
| 2: | 10.5x | ↗ |
| 3: | 9.6 | ↘ |
| 4: | 10.7x | → |
| 5: | 10.1 | ↖ |
| 6: | 10.5 | ← |

| | |
|--------------|-------------|
| Serie | 57.0 |
| Total | 0.0 |

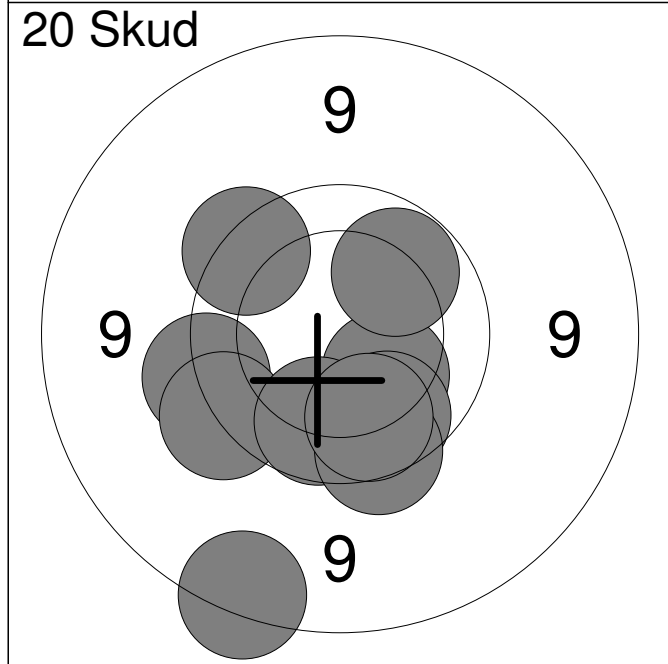

| | | |
|-----|------|---|
| 1: | 9.6 | ← |
| 2: | 8.8 | ↘ |
| 3: | 10.2 | ↘ |
| 4: | 9.9 | ↘ |
| 5: | 9.6 | ↖ |
| 6: | 9.7 | ↗ |
| 7: | 9.9 | ↘ |
| 8: | 9.7 | ↘ |
| 9: | 10.0 | ↗ |
| 10: | 9.9 | ↘ |

| | |
|--------------|-------------|
| Serie | 91.0 |
| Total | 91.0 |

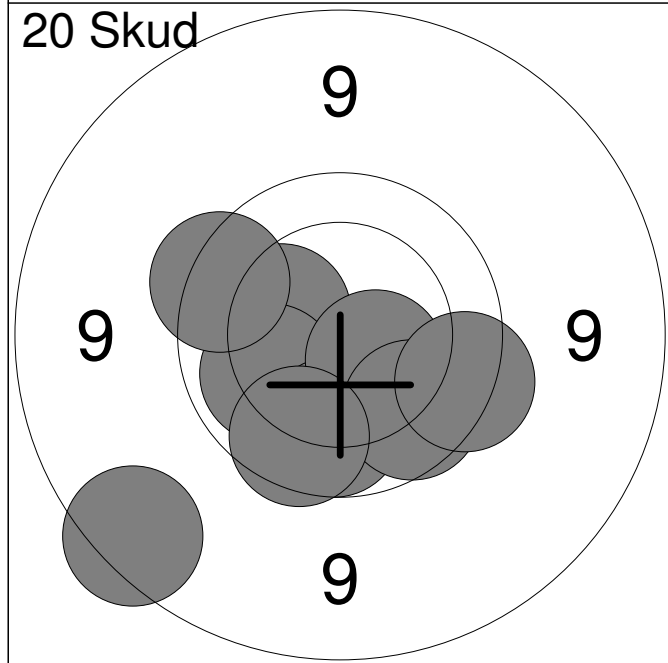

| | | |
|-----|------|---|
| 11: | 8.8 | ↖ |
| 12: | 10.3 | ↗ |
| 13: | 10.2 | ↘ |
| 14: | 10.1 | ↖ |
| 15: | 9.9 | ↘ |
| 16: | 9.7 | ↗ |
| 17: | 10.5 | ↘ |
| 18: | 9.9 | ↘ |
| 19: | 9.8 | ↘ |
| 20: | 9.7 | ↘ |

| | |
|--------------|--------------|
| Serie | 93.0 |
| Total | 184.0 |

| | | | |
|-------------------|-------------------|-----------------------------|--|
| Hold 25 | Skive 4 | Emil Myrup Langgaard | |
|-------------------|-------------------|-----------------------------|--|

| | | | |
|-----|--------------------------|----|--|
| 15m | Løgstør Sportsskytteklub | J1 | |
|-----|--------------------------|----|--|

| | | | |
|--|---------------------------------|---------------------|--|
| | 15 meter riffelstævne oktober 2 | Aalborg Skyttekreds | |
|--|---------------------------------|---------------------|--|

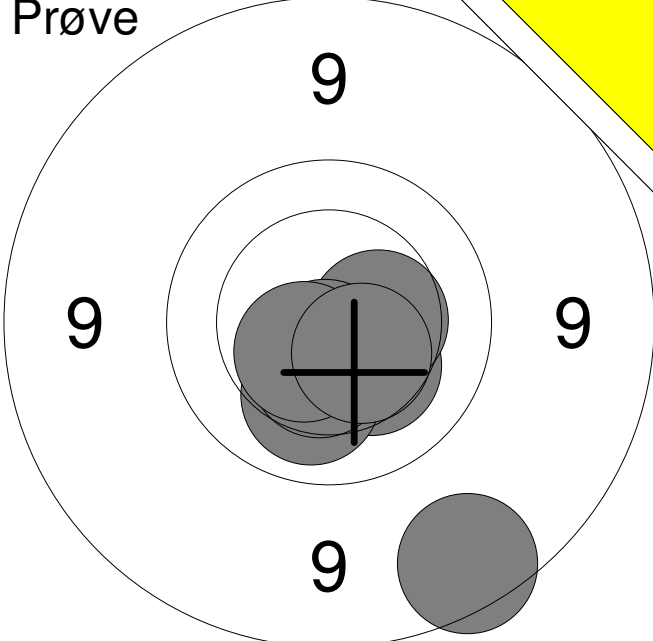
| | | | |
|--|--------------|------------|-------------|
| Prøve  | 1: | 8.9 | ↘ |
| | 2: | 10.3 | ↘ |
| | 3: | 10.4 | → |
| | 4: | 10.1 | ↘ |
| | 5: | 10.7x | ↘ |
| | 6: | 10.4 | ↘ |
| | 7: | 10.5x | ↙ |
| | 8: | 10.5 | ↘ |
| | Serie | | 78.0 |
| Total | | 0.0 | |

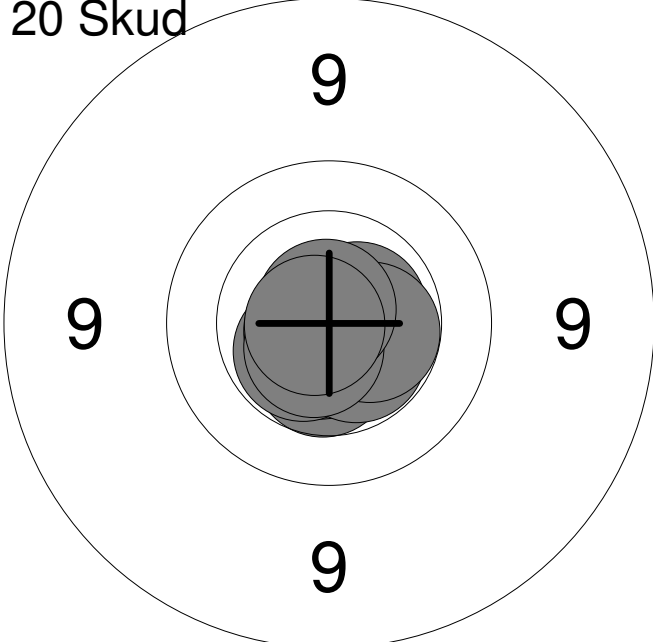
| | | | |
|---|--------------|--------------|--------------|
| 20 Skud  | 1: | 10.5 | ↘ |
| | 2: | 10.7x | ↘ |
| | 3: | 10.6x | → |
| | 4: | 10.5x | ↙ |
| | 5: | 10.5x | ↘ |
| | 6: | 10.8x | ↙ |
| | 7: | 10.5x | → |
| | 8: | 10.6x | ↘ |
| | 9: | 10.8x | ↑ |
| | 10: | 10.8x | ← |
| | Serie | | 100.0 |
| Total | | 100.0 | |

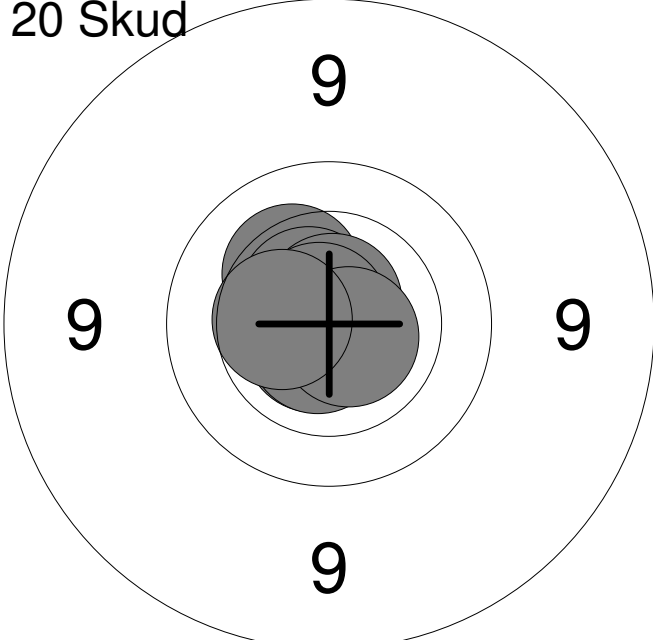
| | | | |
|--|--------------|--------------|--------------|
| 20 Skud  | 11: | 10.7x | ↙ |
| | 12: | 10.8x | ↙ |
| | 13: | 10.3 | ↗ |
| | 14: | 10.6x | ↗ |
| | 15: | 10.7x | ← |
| | 16: | 10.7x | ↑ |
| | 17: | 10.8x | ↗ |
| | 18: | 10.7x | ↘ |
| | 19: | 10.7x | ↘ |
| | 20: | 10.4 | ← |
| | Serie | | 100.0 |
| Total | | 200.0 | |

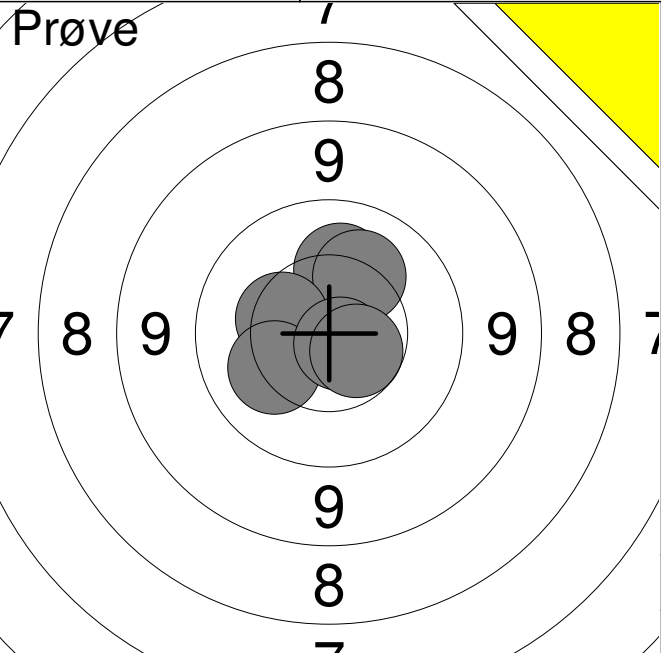
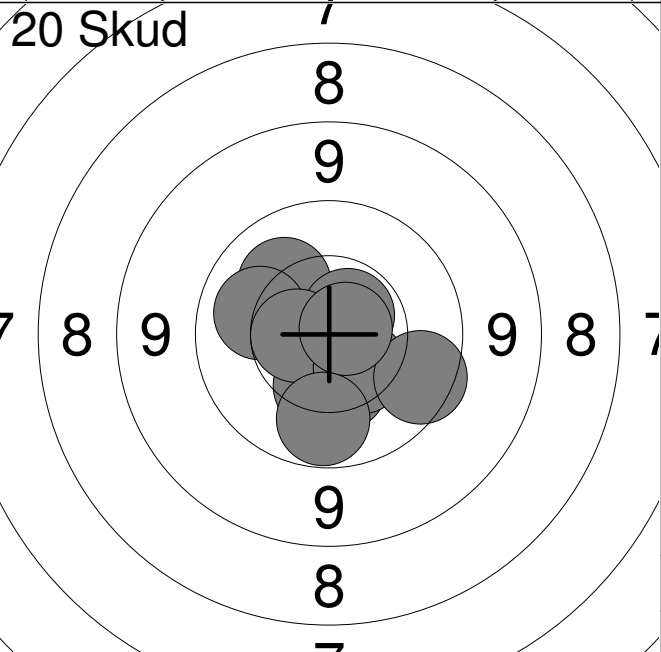
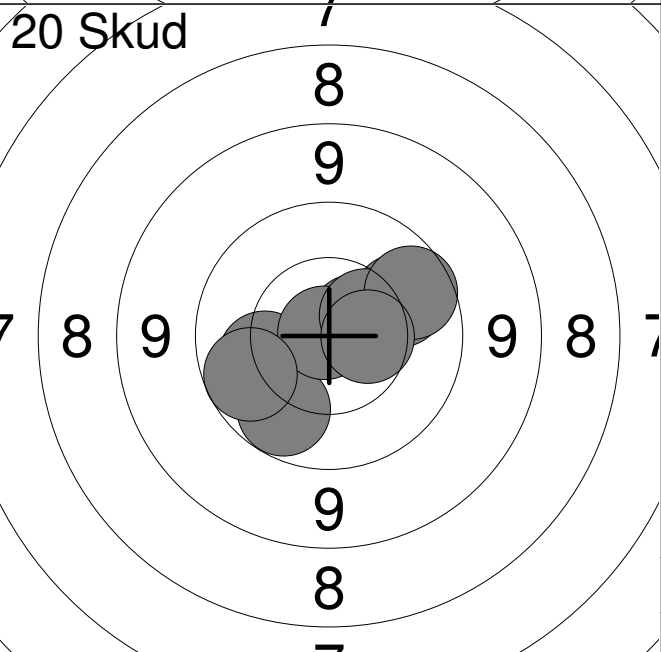
| | | 15 meter riffelstævne oktober 2 | Aalborg Skyttekreds | | |
|---------|-------|--|---------------------|-------------|---|
| Prøve | 7 | | 1: | 10.2 | ↑ |
| | 8 | | 2: | 10.2 | ↗ |
| | 9 | | 3: | 10.4 | ← |
| | 9 | | 4: | 10.2 | ↙ |
| | 7 8 9 |  | 5: | 10.8x | ↘ |
| | 9 8 7 | | 6: | 10.6 | ↘ |
| | 8 7 | | Serie | 60.0 | |
| | | Total | 0.0 | | |
| 20 Skud | 7 | | 1: | 10.4 | ↓ |
| | 8 | | 2: | 10.2 | ↗ |
| | 9 | | 3: | 10.3 | ↓ |
| | 9 | | 4: | 10.1 | ← |
| | 7 8 9 |  | 5: | 10.6x | ↗ |
| | 9 8 7 | | 6: | 10.6 | ← |
| | 8 7 | | 7: | 10.4 | ↓ |
| | | | 8: | 9.8 | ↘ |
| | | | 9: | 10.7x | → |
| | | | 10: | 10.0 | ↓ |
| | | | Serie | 99.0 | |
| | | Total | 99.0 | | |
| 20 Skud | 7 | | 11: | 10.2 | ← |
| | 8 | | 12: | 10.6x | ↗ |
| | 9 | | 13: | 10.0 | ↓ |
| | 9 | | 14: | 10.0 | ↗ |
| | 7 8 9 |  | 15: | 10.5 | ↗ |
| | 9 8 7 | | 16: | 10.9x | ↗ |
| | 8 7 | | 17: | 9.9 | ← |
| | | | 18: | 10.5 | ↗ |
| | | | 19: | 9.9 | ↗ |
| | | | 20: | 10.5 | → |
| | | | Serie | 98.0 | |
| | | Total | 197.0 | | |

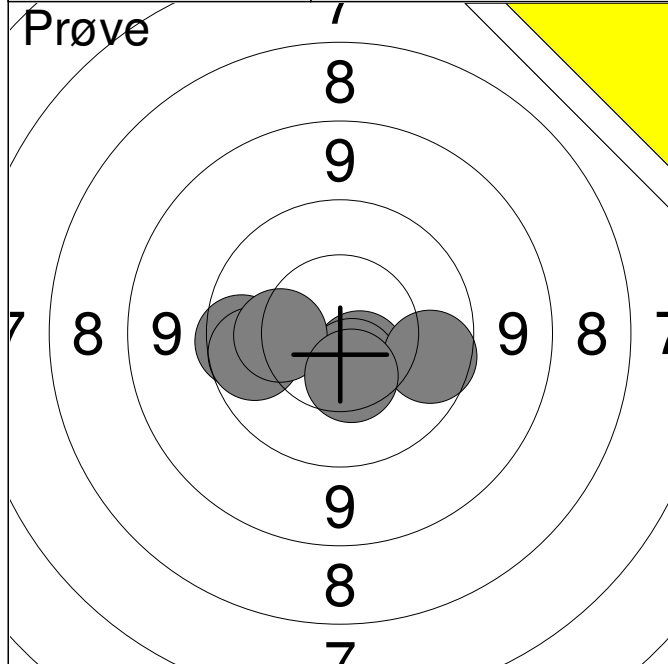

| | | |
|--------------|-------|-------------|
| 1: | 10.6x | ↘ |
| 2: | 10.6 | ↘ |
| 3: | 9.8 | ← |
| 4: | 9.9 | ← |
| 5: | 10.3 | ← |
| 6: | 9.9 | → |
| 7: | 10.4 | ↘ |
| Serie | | 67.0 |
| Total | | 0.0 |

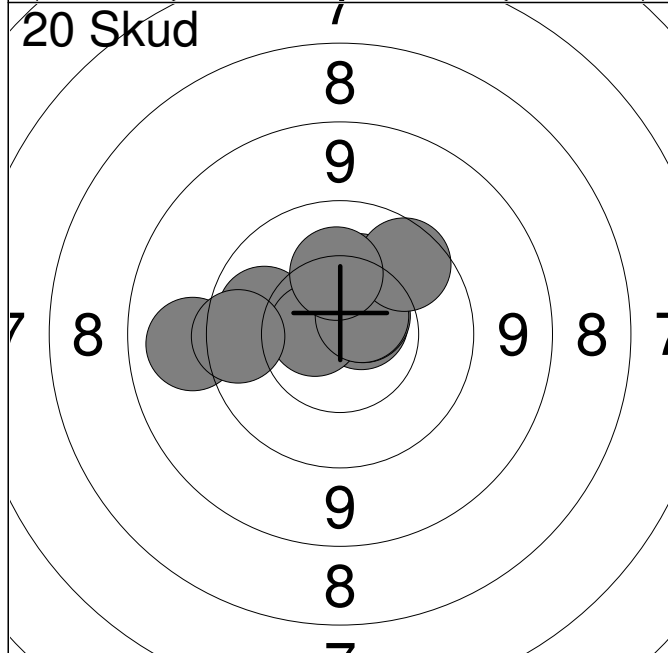

| | | |
|--------------|-------|-------------|
| 1: | 10.7x | ↗ |
| 2: | 10.6x | ↗ |
| 3: | 10.0 | ← |
| 4: | 10.7x | ← |
| 5: | 10.3 | ↑ |
| 6: | 10.6x | ↗ |
| 7: | 9.8 | ↗ |
| 8: | 9.2 | ← |
| 9: | 10.2 | ↑ |
| 10: | 9.7 | ← |
| Serie | | 97.0 |
| Total | | 97.0 |

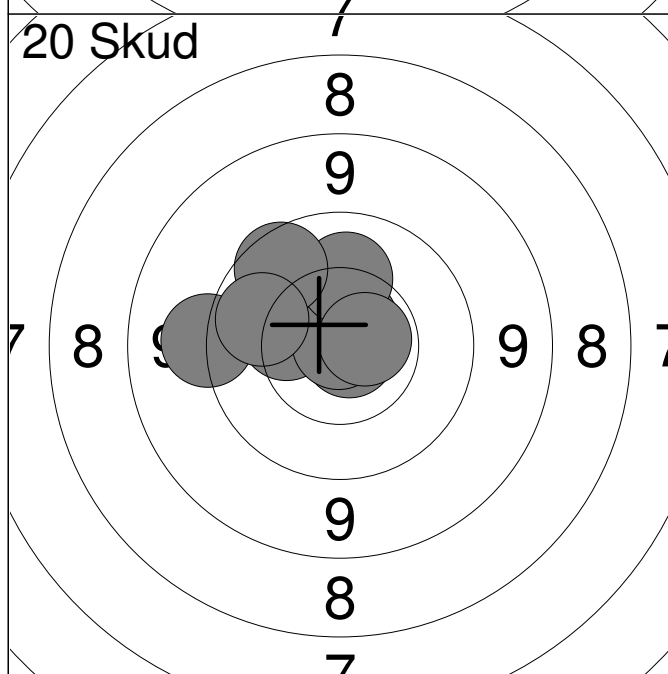

| | | |
|--------------|-------|--------------|
| 11: | 10.2 | ← |
| 12: | 9.4 | ← |
| 13: | 10.8x | ↘ |
| 14: | 10.3 | ← |
| 15: | 10.6x | ↗ |
| 16: | 10.9x | ↗ |
| 17: | 10.2 | ↑ |
| 18: | 10.6x | → |
| 19: | 9.8 | ↗ |
| 20: | 10.0 | ← |
| Serie | | 98.0 |
| Total | | 195.0 |

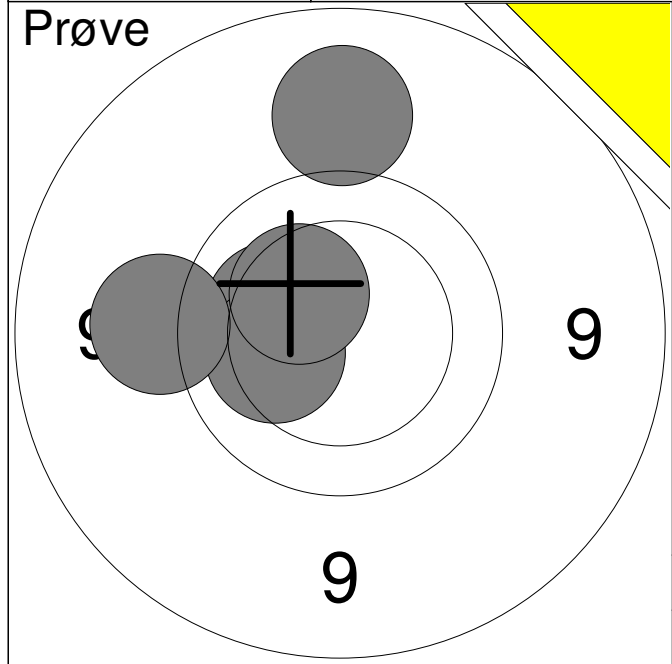

| | | | |
|--------------|----|------|-------------|
| | 1: | 9.2 | ↑ |
| | 2: | 10.2 | ↖ |
| | 3: | 10.2 | ↖ |
| | 4: | 10.3 | ↗ |
| | 5: | 9.4 | ↖ |
| Serie | | | 48.0 |
| Total | | | 0.0 |

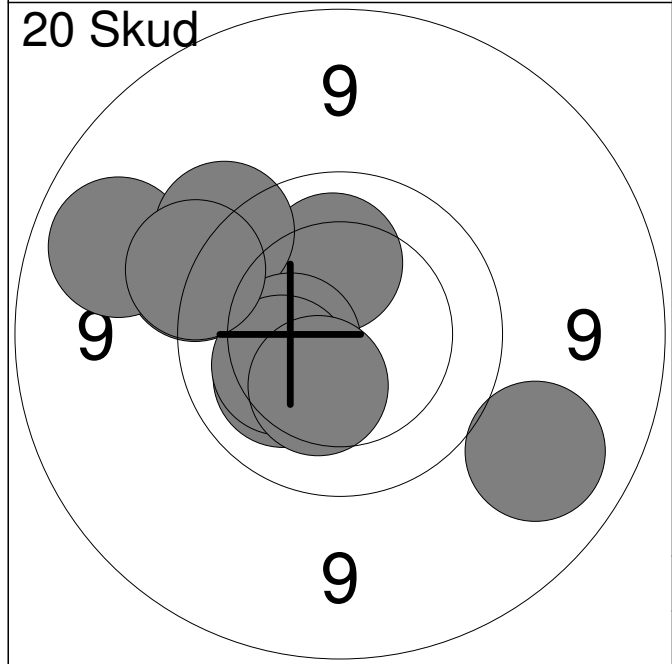

| | | | |
|--------------|-----|------|-------------|
| | 1: | 9.1 | ↘ |
| | 2: | 9.5 | ↗ |
| | 3: | 9.1 | ↗ |
| | 4: | 10.2 | ↑ |
| | 5: | 9.6 | ↗ |
| | 6: | 10.2 | ↖ |
| | 7: | 10.4 | ↖ |
| | 8: | 10.2 | ↖ |
| | 9: | 9.5 | ↗ |
| | 10: | 10.3 | ↘ |
| Serie | | | 95.0 |
| Total | | | 95.0 |

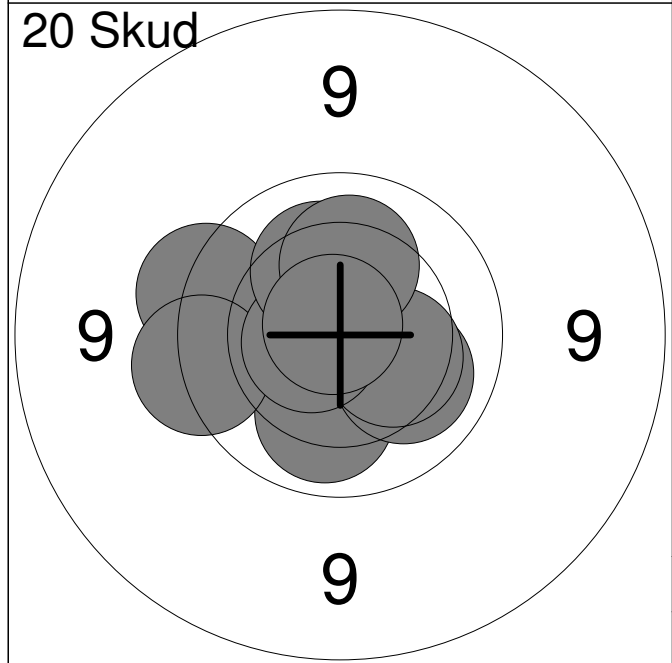

| | | | |
|--------------|-----|-------|--------------|
| | 11: | 9.7 | ↖ |
| | 12: | 10.4 | ↘ |
| | 13: | 10.1 | ↘ |
| | 14: | 9.6 | ↖ |
| | 15: | 10.1 | ↘ |
| | 16: | 10.3 | ↘ |
| | 17: | 10.6x | ↖ |
| | 18: | 10.2 | ↑ |
| | 19: | 10.2 | ↑ |
| | 20: | 10.8x | ↗ |
| Serie | | | 98.0 |
| Total | | | 193.0 |

| | | |
|-------------------|-------------------|--|
| Hold 25 | Skive 8 | |
|-------------------|-------------------|--|

| | | |
|-----|--|--|
| 15m | | |
|-----|--|--|

| | | |
|--|---------------------------------|---------------------|
| | 15 meter riffelstævne oktober 2 | Aalborg Skyttekreds |
|--|---------------------------------|---------------------|

Prøve

| |
|--|
| |
|--|

| | |
|-------|---|
| Serie | 0 |
|-------|---|

| | |
|-------|---|
| Total | 0 |
|-------|---|

| | | |
|-------------------|-------------------|-----------------------|
| Hold 25 | Skive 9 | Michael Brasch |
|-------------------|-------------------|-----------------------|

| | | |
|-----|--------------------------|-----|
| 15m | Midtdjurs Skytteforening | ÅK1 |
|-----|--------------------------|-----|

| | | |
|--|---------------------------------|---------------------|
| | 15 meter riffelstævne oktober 2 | Aalborg Skyttekreds |
|--|---------------------------------|---------------------|

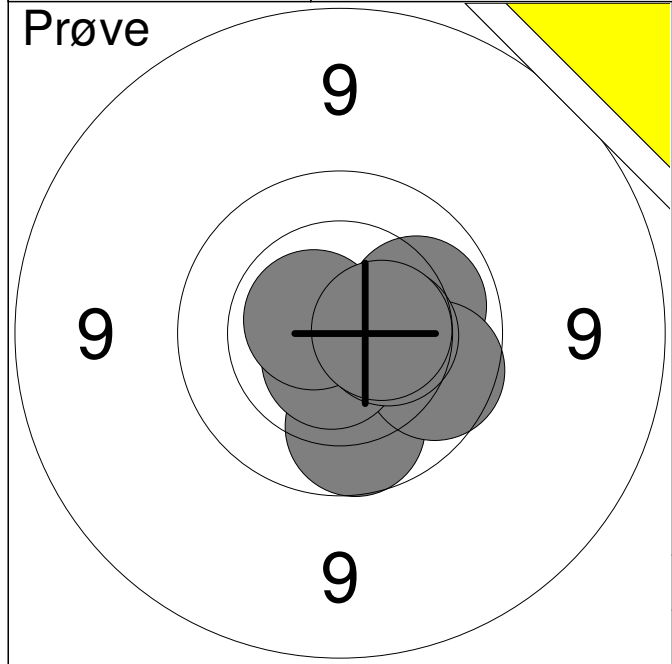

| | | |
|--------------|-------|-------------|
| 1: | 10.1 | → |
| 2: | 9.9 | ↓ |
| 3: | 9.9 | → |
| 4: | 10.7x | ↓ |
| 5: | 10.4 | → |
| 6: | 10.6x | ↗ |
| 7: | 10.5x | → |
| Serie | | 68.0 |
| Total | | 0.0 |

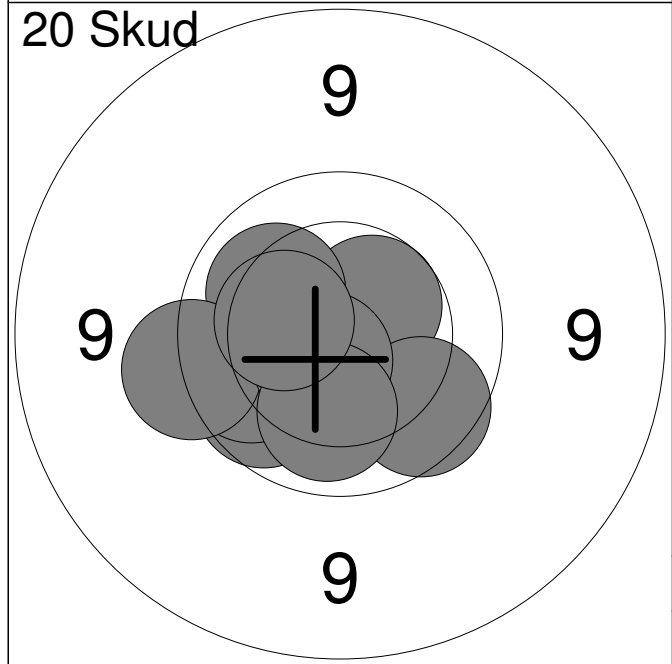

| | | |
|--------------|-------|-------------|
| 1: | 10.3 | ↓ |
| 2: | 10.5x | ↗ |
| 3: | 9.9 | ↓ |
| 4: | 9.9 | ↙ |
| 5: | 9.9 | ↙ |
| 6: | 10.1 | ↗ |
| 7: | 9.6 | ↙ |
| 8: | 10.6x | ↓ |
| 9: | 10.1 | ↓ |
| 10: | 10.3 | ↙ |
| Serie | | 96.0 |
| Total | | 96.0 |

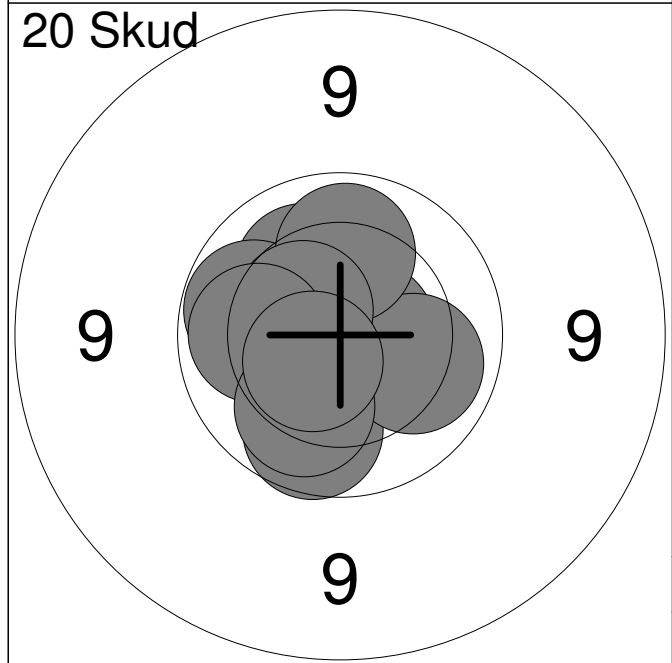

| | | |
|--------------|-------|--------------|
| 11: | 9.9 | ↓ |
| 12: | 10.2 | ↗ |
| 13: | 10.7x | → |
| 14: | 10.0 | ↙ |
| 15: | 10.1 | → |
| 16: | 10.1 | ↑ |
| 17: | 10.5 | ↗ |
| 18: | 10.1 | ↙ |
| 19: | 10.1 | ↓ |
| 20: | 10.5x | ↙ |
| Serie | | 99.0 |
| Total | | 195.0 |

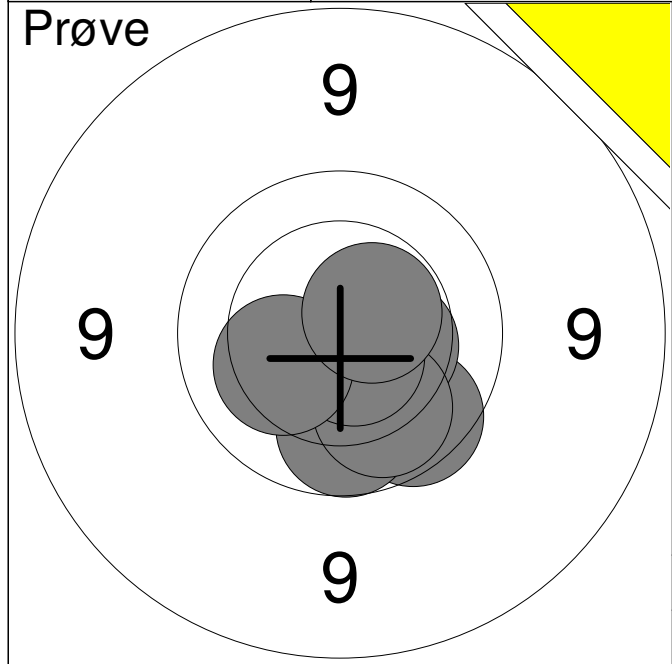

| | | |
|--------------|-------|-------------|
| 1: | 9.8 | ↘ |
| 2: | 9.9 | ↘ |
| 3: | 10.7x | ↘ |
| 4: | 10.4 | → |
| 5: | 10.0 | ↘ |
| 6: | 10.7x | ↘ |
| 7: | 10.2 | ↙ |
| 8: | 10.5x | ↗ |
| Serie | | 78.0 |
| Total | | 0.0 |

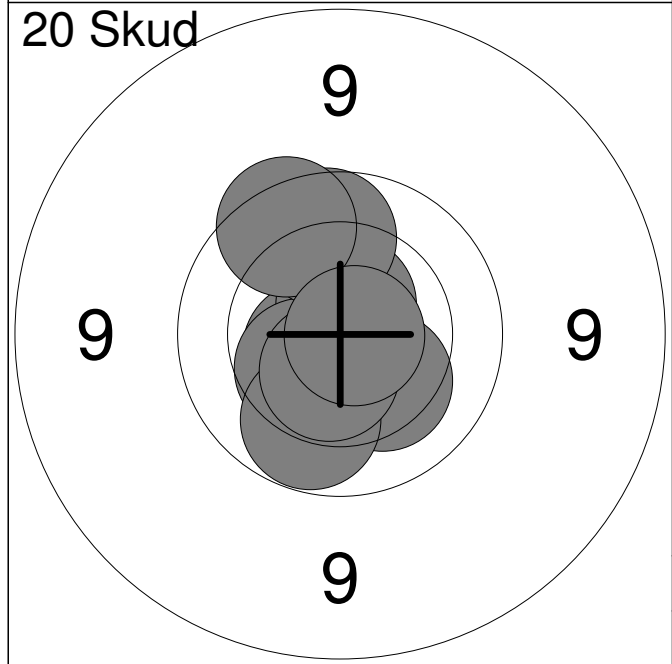

| | | |
|--------------|-------|-------------|
| 1: | 10.6x | ↙ |
| 2: | 10.5x | ↘ |
| 3: | 10.6x | ↑ |
| 4: | 10.4 | ↙ |
| 5: | 10.3 | ↘ |
| 6: | 10.0 | ↘ |
| 7: | 10.5x | ↘ |
| 8: | 9.9 | ↑ |
| 9: | 9.8 | ↑ |
| 10: | 10.8x | → |
| Serie | | 98.0 |
| Total | | 98.0 |

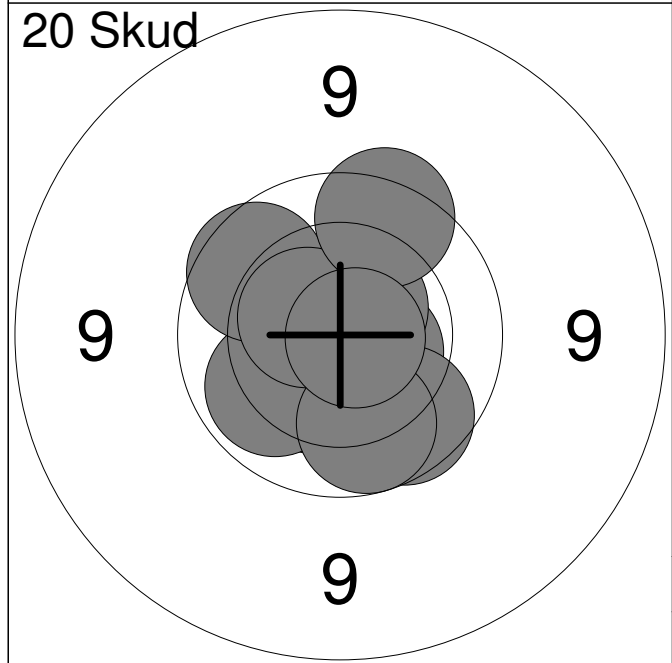

| | | |
|--------------|-------|--------------|
| 11: | 10.4 | ↘ |
| 12: | 10.5x | → |
| 13: | 10.1 | ↙ |
| 14: | 9.9 | ↘ |
| 15: | 9.9 | ↗ |
| 16: | 10.6x | ↗ |
| 17: | 10.5x | ↗ |
| 18: | 9.7 | ↑ |
| 19: | 10.0 | ↘ |
| 20: | 10.8x | → |
| Serie | | 97.0 |
| Total | | 195.0 |

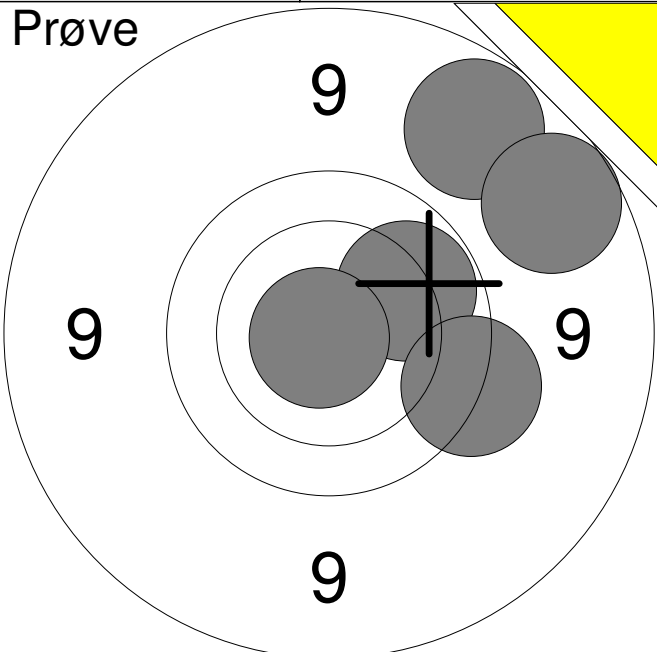
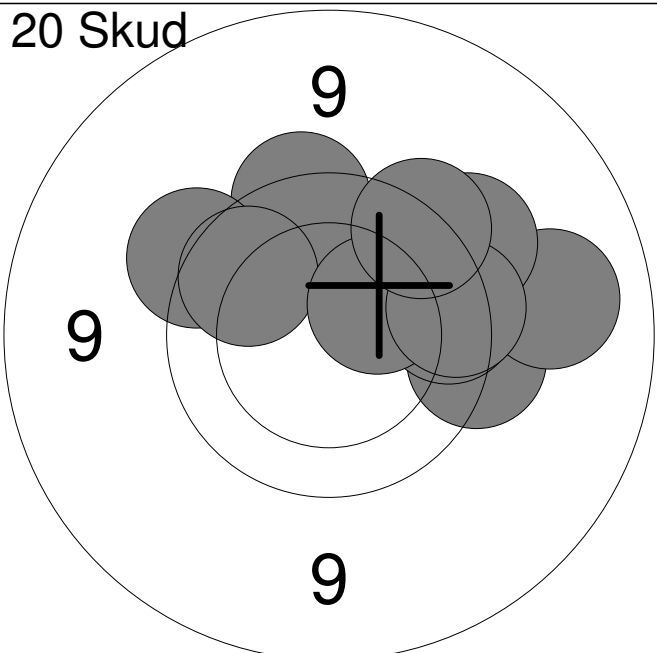
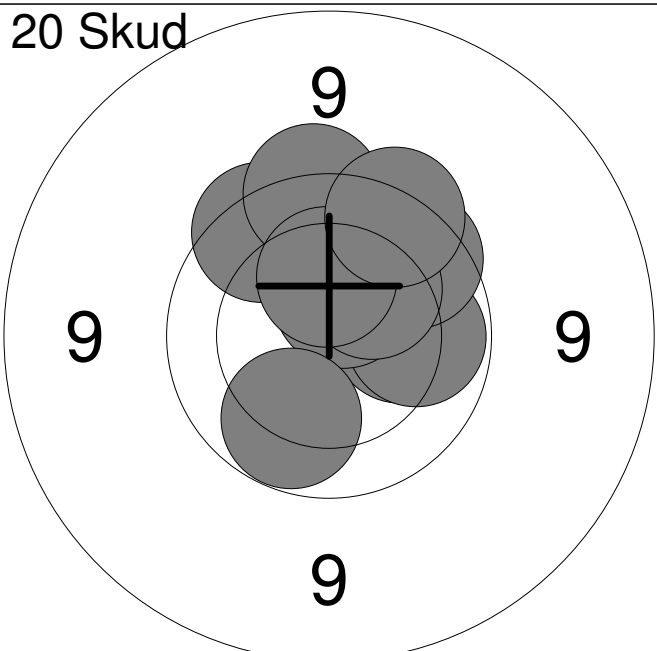
| Hold | Skive | Erling Pedersen | |
|---------|--|---------------------|-----|
| 25 | 11 | | |
| 15m | Hobro Egnens Skytteforening | | MÅ2 |
| | 15 meter riffelstævne oktober 2 | Aalborg Skyttekreds | |
| Prøve |  | 1: 9.0 ↗ | |
| | | 2: 8.9 → | |
| | | 3: 10.0 → | |
| | | 4: 9.6 → | |
| | | 5: 10.8x ← | |
| | Serie | 46.0 | |
| | Total | 0.0 | |
| 20 Skud |  | 1: 9.6 → | |
| | | 2: 9.7 ↑ | |
| | | 3: 9.1 → | |
| | | 4: 9.5 → | |
| | | 5: 9.6 ↗ | |
| | | 6: 9.8 → | |
| | | 7: 9.9 ↗ | |
| | | 8: 10.3 → | |
| | | 9: 9.7 → | |
| | | 10: 9.7 ↗ | |
| | Serie | 91.0 | |
| | Total | 91.0 | |
| 20 Skud |  | 11: 10.2 → | |
| | | 12: 10.0 → | |
| | | 13: 10.5x ↑ | |
| | | 14: 9.8 ↗ | |
| | | 15: 9.8 ↗ | |
| | | 16: 9.6 ↑ | |
| | | 17: 10.3 ↗ | |
| | | 18: 10.0 ↘ | |
| | | 19: 10.3 ↑ | |
| | | 20: 9.7 ↗ | |
| | Serie | 96.0 | |
| | Total | 187.0 | |

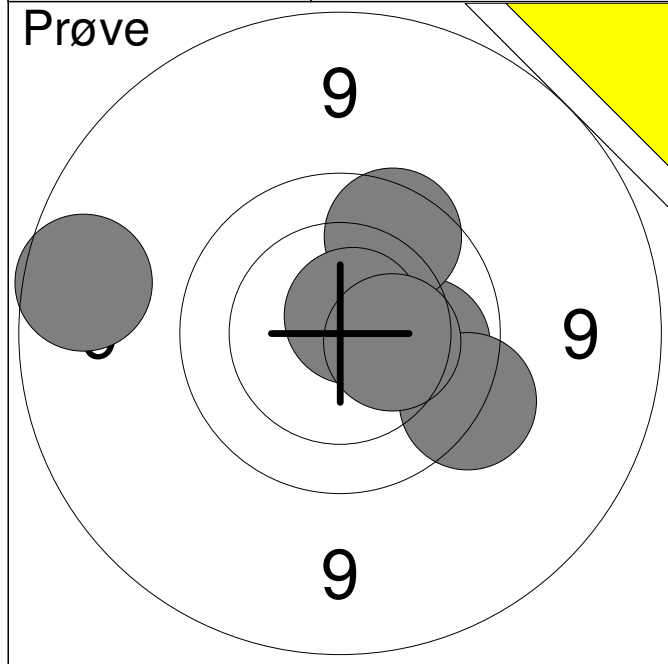

| | | |
|----|-------|---|
| 1: | 10.0 | → |
| 2: | 8.9 | ← |
| 3: | 9.8 | ↗ |
| 4: | 10.7x | ↗ |
| 5: | 9.6 | → |
| 6: | 10.4 | → |

| | |
|--------------|-------------|
| Serie | 56.0 |
| Total | 0.0 |

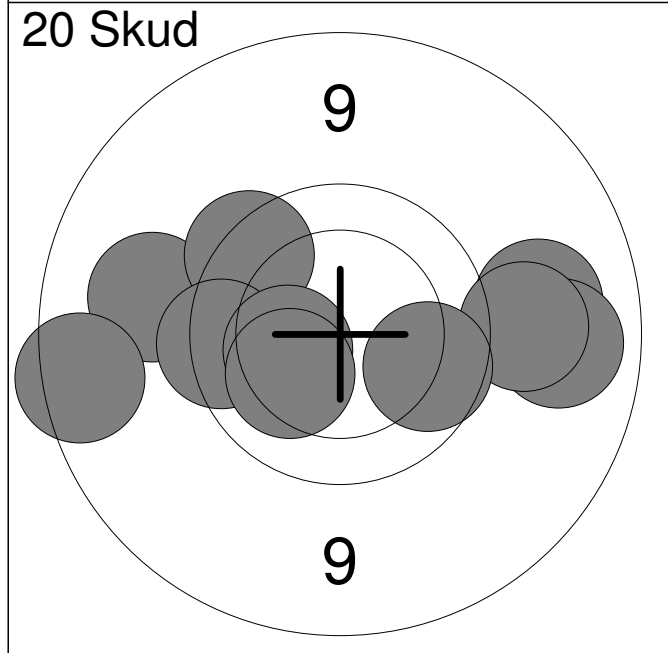

| | | |
|-----|------|---|
| 1: | 9.3 | ← |
| 2: | 9.7 | ↗ |
| 3: | 8.8 | ← |
| 4: | 9.2 | → |
| 5: | 9.1 | → |
| 6: | 9.3 | → |
| 7: | 9.7 | ← |
| 8: | 10.3 | ← |
| 9: | 9.9 | → |
| 10: | 10.2 | ↙ |

| | |
|--------------|-------------|
| Serie | 91.0 |
| Total | 91.0 |

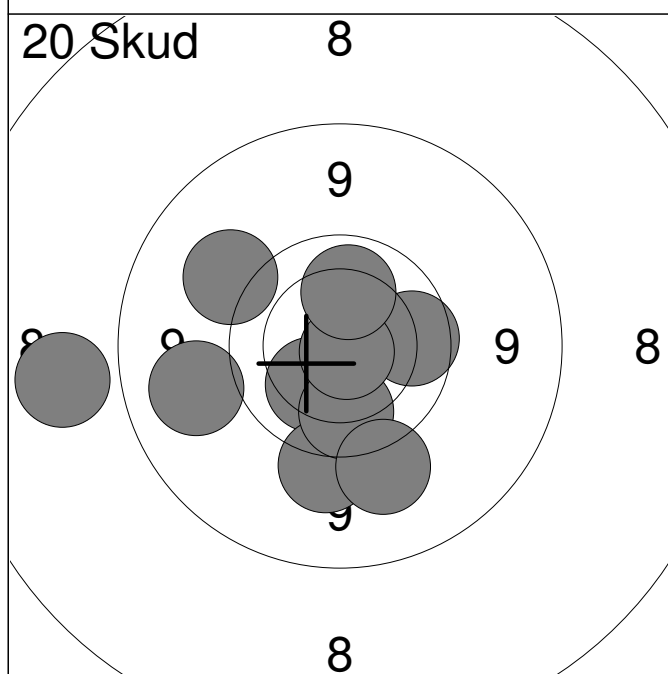

| | | |
|-----|-------|---|
| 11: | 10.2 | ↙ |
| 12: | 9.2 | ← |
| 13: | 9.4 | ↓ |
| 14: | 9.9 | → |
| 15: | 9.4 | ↗ |
| 16: | 9.9 | ↓ |
| 17: | 9.4 | ↓ |
| 18: | 8.3 | ← |
| 19: | 10.8x | ↘ |
| 20: | 10.1 | ↑ |

| | |
|--------------|--------------|
| Serie | 92.0 |
| Total | 183.0 |

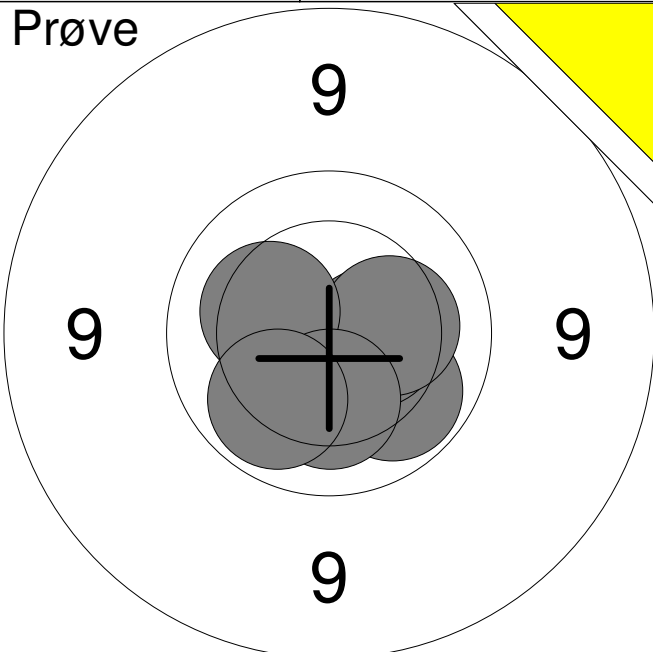
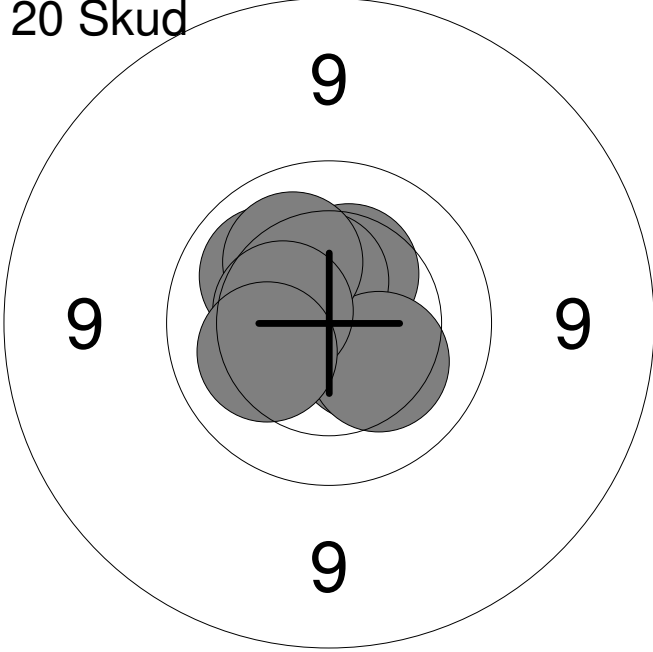
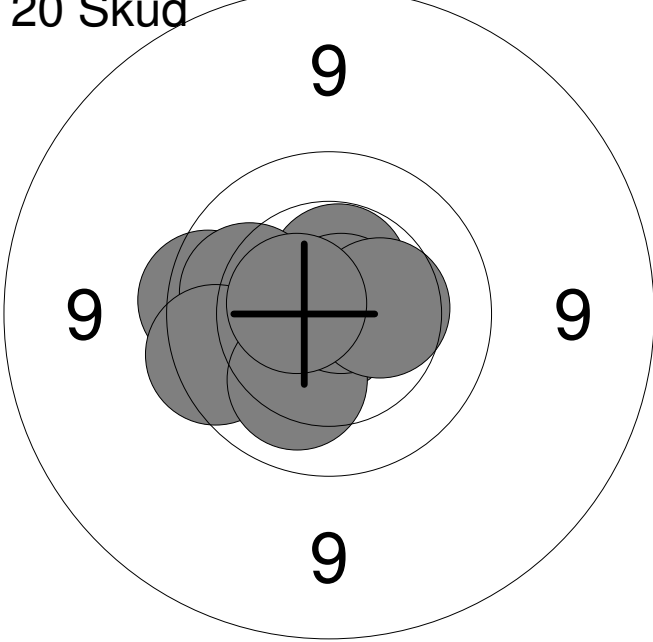
| Hold | Skive | Frederik B. Sørensen | |
|---------|--|--------------------------|--------------|
| 26 | 1 | Løgstør Sportsskytteklub | MJ1 |
| 15m | 15 meter riffelstævne oktober 2 | Aalborg Skyttekreds | |
| Prøve |  | 1: 10.0 ↘ | |
| | | 2: 10.4 ↓ | |
| | | 3: 10.5x → | |
| | | 4: 10.3 → | |
| | | 5: 10.3 ↗ | |
| | | 6: 10.2 ↓ | |
| | | 7: 10.0 ↘ | |
| | | Serie | 70.0 |
| | | Total | 0.0 |
| 20 Skud |  | 1: 10.4 ↖ | |
| | | 2: 10.8x ↙ | |
| | | 3: 10.5 ↓ | |
| | | 4: 10.4 ↗ | |
| | | 5: 10.5 ↗ | |
| | | 6: 10.1 ↗ | |
| | | 7: 10.3 ↓ | |
| | | 8: 10.2 ↗ | |
| | | 9: 10.4 ↖ | |
| | | 10: 10.2 ↙ | |
| | | Serie | 100.0 |
| | | Total | 100.0 |
| 20 Skud |  | 11: 9.8 ← | |
| | | 12: 9.8 ← | |
| | | 13: 10.8x ↓ | |
| | | 14: 10.5x ↑ | |
| | | 15: 10.1 ← | |
| | | 16: 9.8 ← | |
| | | 17: 10.2 ↓ | |
| | | 18: 10.8x ↗ | |
| | | 19: 10.4 → | |
| | | 20: 10.6x ← | |
| | | Serie | 97.0 |
| | | Total | 197.0 |

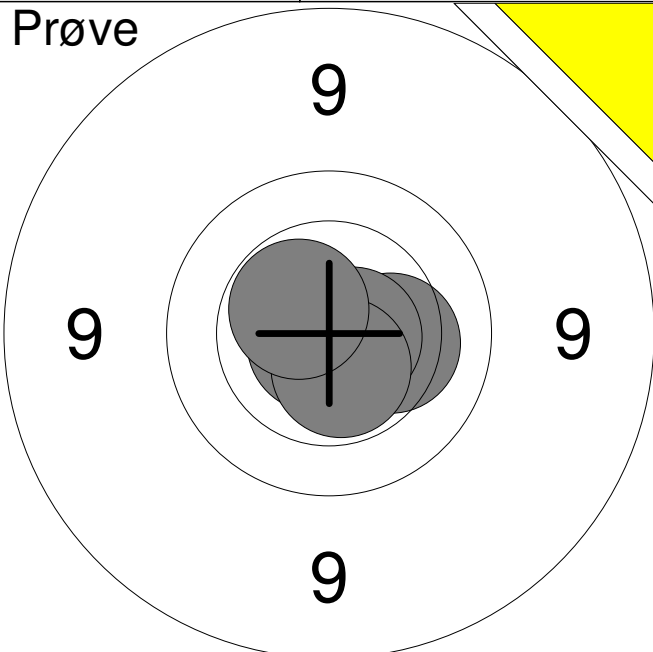
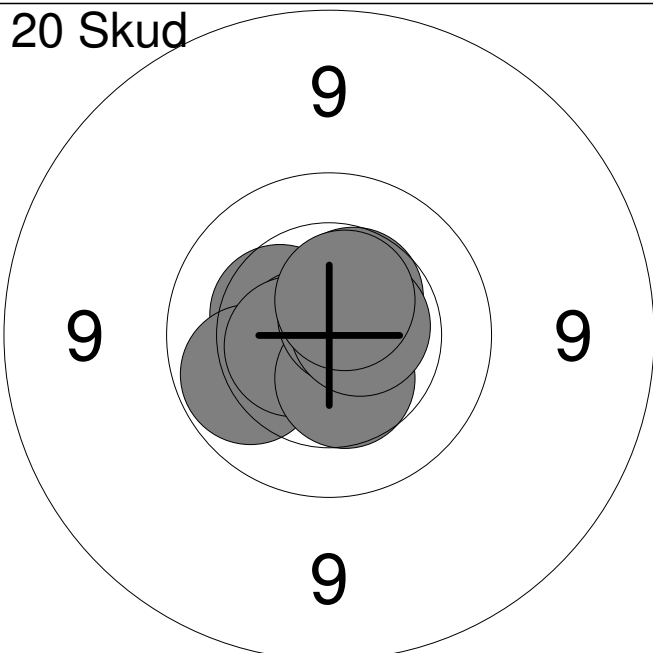
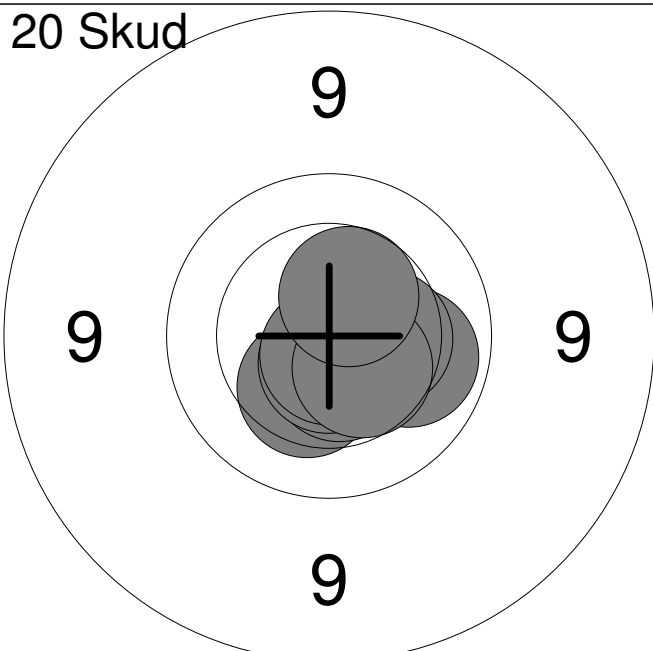
| Hold | Skive | Simon Andersen | |
|---------|--|---------------------|--------------|
| 26 | 2 | | |
| 15m | Løgstør Sportsskytteklub | MJ1 | |
| | 15 meter riffelstævne oktober 2 | Aalborg Skyttekreds | |
| Prøve |  | 1: 10.8x ↙ | |
| | | 2: 10.3 → | |
| | | 3: 10.7x → | |
| | | 4: 10.6x ↓ | |
| | | 5: 10.5x ↗ | |
| | | Serie | 50.0 |
| | | Total | 0.0 |
| 20 Skud |  | 1: 10.4 ↙ | |
| | | 2: 10.7x ← | |
| | | 3: 10.0 ↙ | |
| | | 4: 10.5x ← | |
| | | 5: 10.6x → | |
| | | 6: 10.4 ↓ | |
| | | 7: 10.7x ↗ | |
| | | 8: 10.5 ↗ | |
| | | 9: 10.6x → | |
| | | 10: 10.5x ↗ | |
| | | Serie | 100.0 |
| | | Total | 100.0 |
| 20 Skud |  | 11: 10.7x → | |
| | | 12: 10.1 → | |
| | | 13: 10.4 → | |
| | | 14: 10.8x → | |
| | | 15: 10.3 ↓ | |
| | | 16: 10.5x ↓ | |
| | | 17: 10.7x ↓ | |
| | | 18: 10.7x ↓ | |
| | | 19: 10.5 ↓ | |
| | | 20: 10.5 ↗ | |
| | | Serie | 100.0 |
| | | Total | 200.0 |

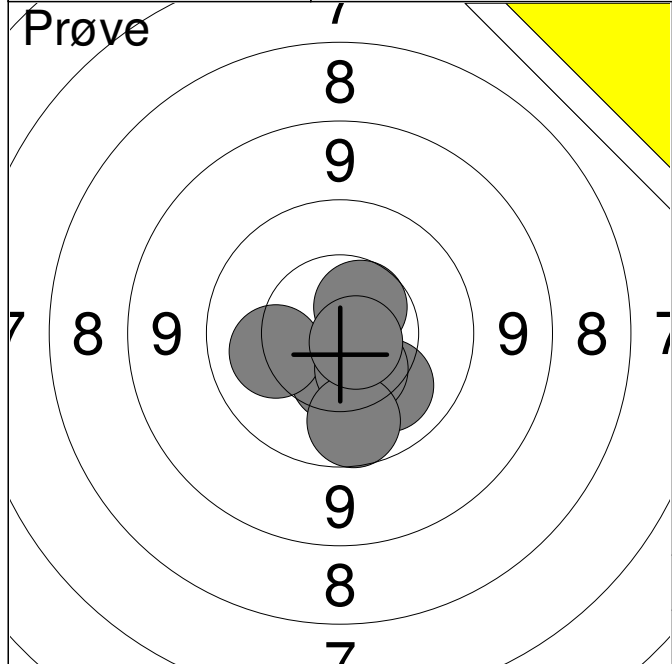

| | | |
|--------------|-------|-------------|
| 1: | 10.1 | ↘ |
| 2: | 10.5 | ↘ |
| 3: | 10.5 | ↘ |
| 4: | 10.2 | ← |
| 5: | 10.6 | ↗ |
| 6: | 10.5 | ↘ |
| 7: | 9.9 | ↘ |
| 8: | 10.7x | ↘ |
| Serie | | 79.0 |
| Total | | 0.0 |

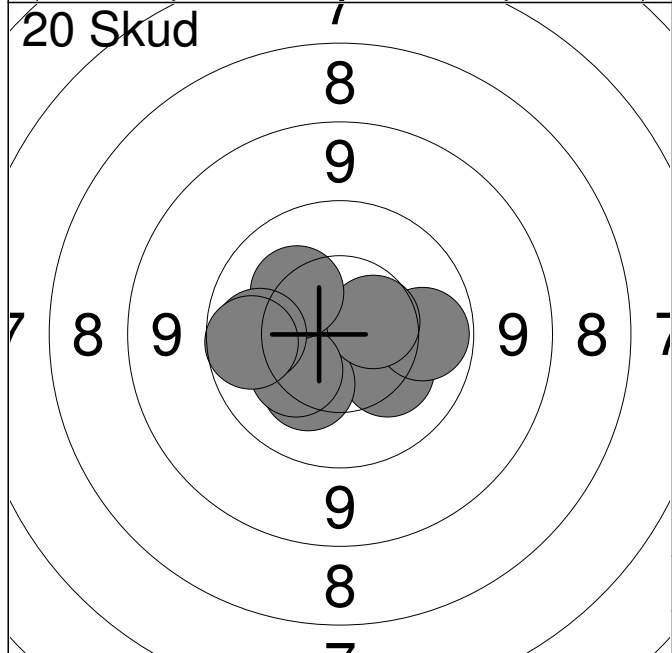

| | | |
|--------------|------|-------------|
| 1: | 10.3 | ↘ |
| 2: | 10.0 | → |
| 3: | 10.3 | ← |
| 4: | 10.5 | ← |
| 5: | 10.3 | ↘ |
| 6: | 10.5 | → |
| 7: | 10.3 | ↘ |
| 8: | 10.3 | ↗ |
| 9: | 10.0 | ← |
| 10: | 9.9 | ← |
| Serie | | 99.0 |
| Total | | 99.0 |

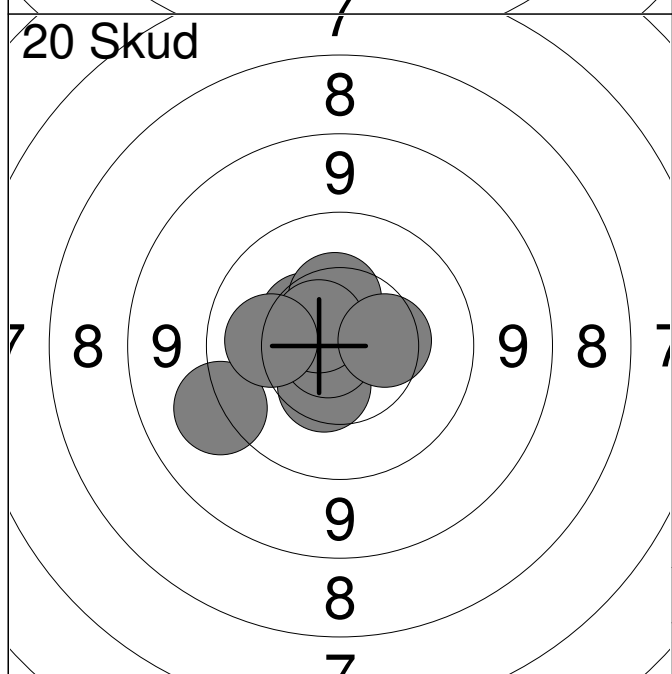

| | | |
|--------------|-------|--------------|
| 11: | 10.5 | ↗ |
| 12: | 9.3 | ← |
| 13: | 10.8x | ← |
| 14: | 10.7x | ↘ |
| 15: | 10.5 | ↘ |
| 16: | 10.8x | ← |
| 17: | 10.4 | ↑ |
| 18: | 10.6x | ↗ |
| 19: | 10.2 | ← |
| 20: | 10.4 | → |
| Serie | | 99.0 |
| Total | | 198.0 |

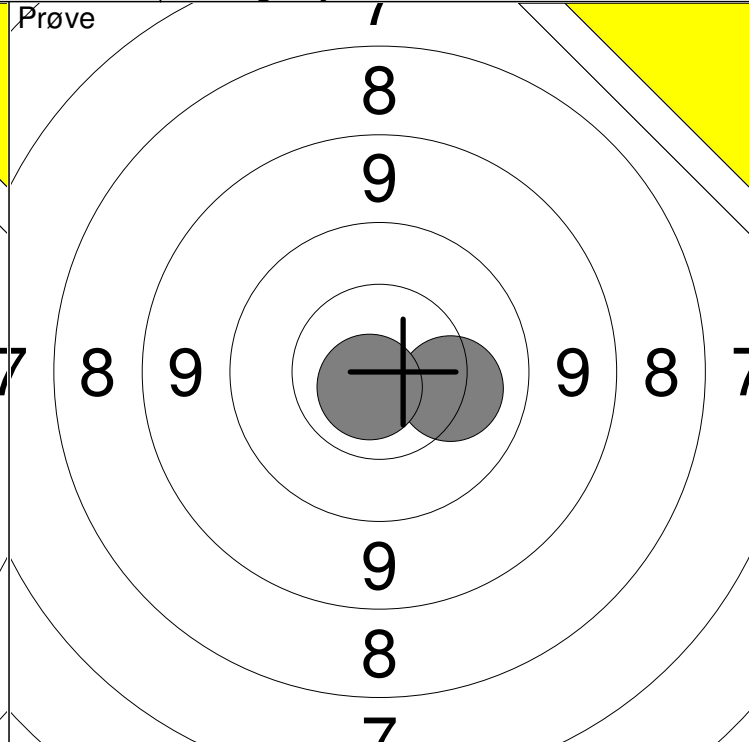
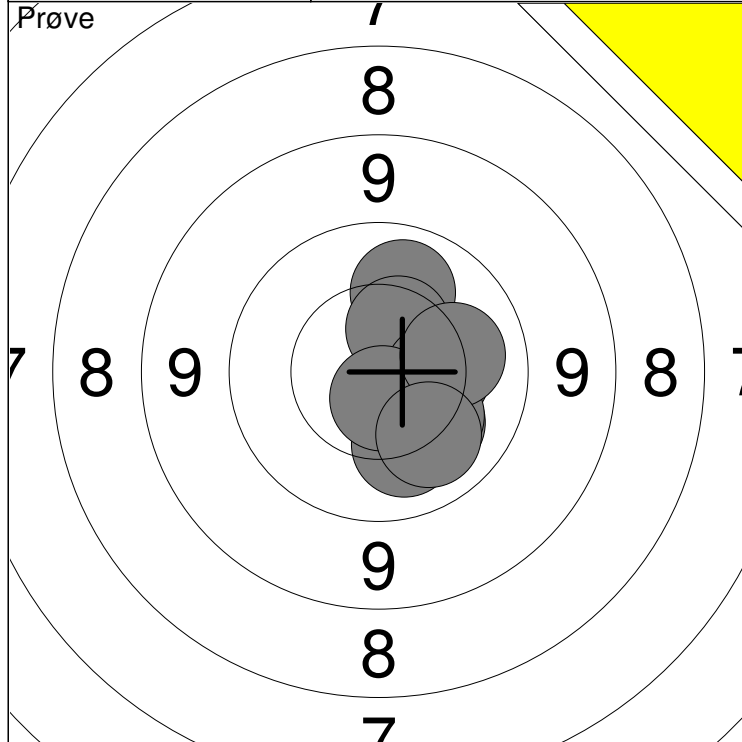

| | | | |
|-----------|------------|-------|-----|
| 1: 10.2 ↓ | 6: 10.3 → | Serie | 100 |
| 2: 10.5 ↓ | 7: 10.2 ↓ | | |
| 3: 10.2 ↓ | 8: 10.7x ↓ | Total | 0 |
| 4: 10.1 ↑ | 9: 10.2 → | | |
| 5: 10.5 ↑ | 10: 10.1 ↓ | | |

| | | |
|-------------|-------|----|
| 11: 10.2 → | Serie | 20 |
| 12: 10.8x ↓ | | |
| Total | | 0 |

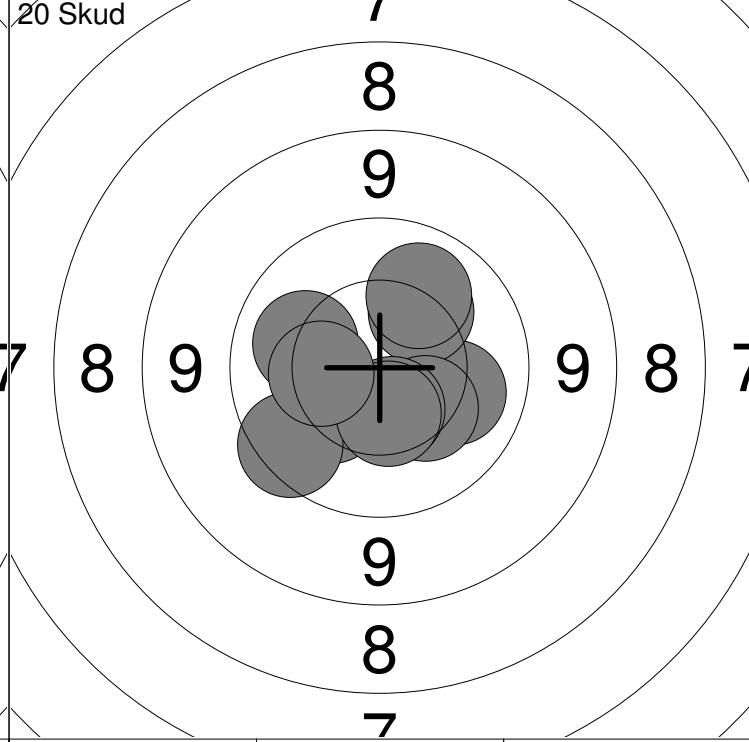
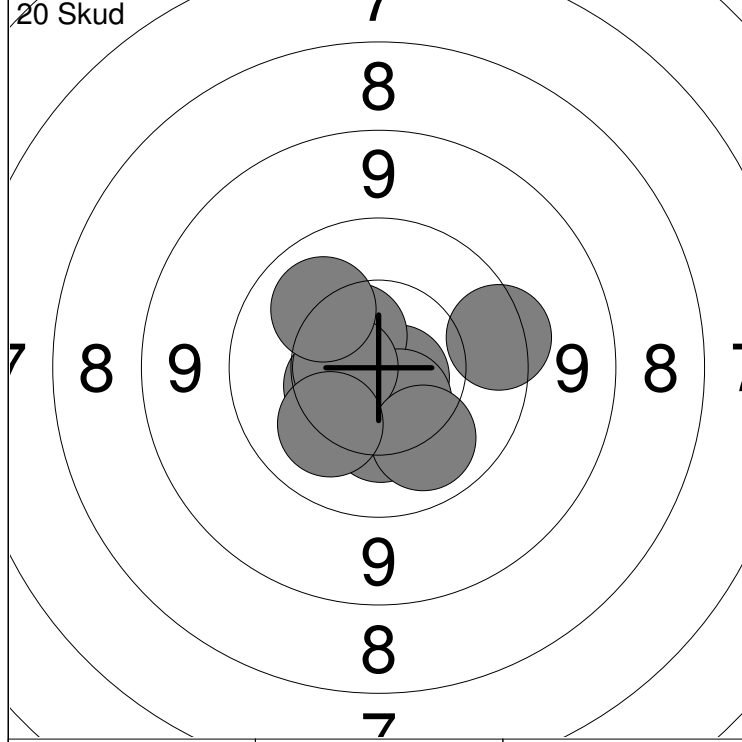

| | | | |
|------------|------------|-------|----|
| 1: 10.7x ↓ | 6: 10.6x ← | Serie | 99 |
| 2: 10.3 ↓ | 7: 10.1 ↓ | | |
| 3: 10.5 ↑ | 8: 10.1 ↑ | Total | 99 |
| 4: 10.5 ← | 9: 9.6 → | | |
| 5: 10.5 ↓ | 10: 10.2 ↓ | | |

| | | | |
|------------|------------|-------|-----|
| 11: 10.1 → | 16: 10.5 ↓ | Serie | 99 |
| 12: 10.2 ↑ | 17: 9.7 ↓ | | |
| 13: 10.3 ↓ | 18: 10.1 ↑ | Total | 198 |
| 14: 10.1 ← | 19: 10.5 ↓ | | |
| 15: 10.3 ↓ | 20: 10.3 ← | | |

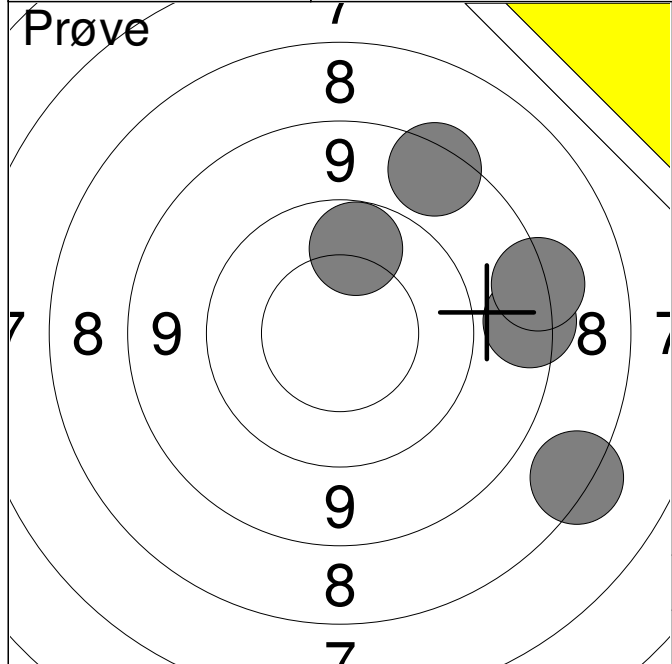

| | | |
|--------------|------|-------------|
| 1: | 8.6 | → |
| 2: | 8.4 | → |
| 3: | 10.0 | ↑ |
| 4: | 7.5 | ↘ |
| 5: | 8.6 | ↗ |
| Serie | | 41.0 |
| Total | | 0.0 |

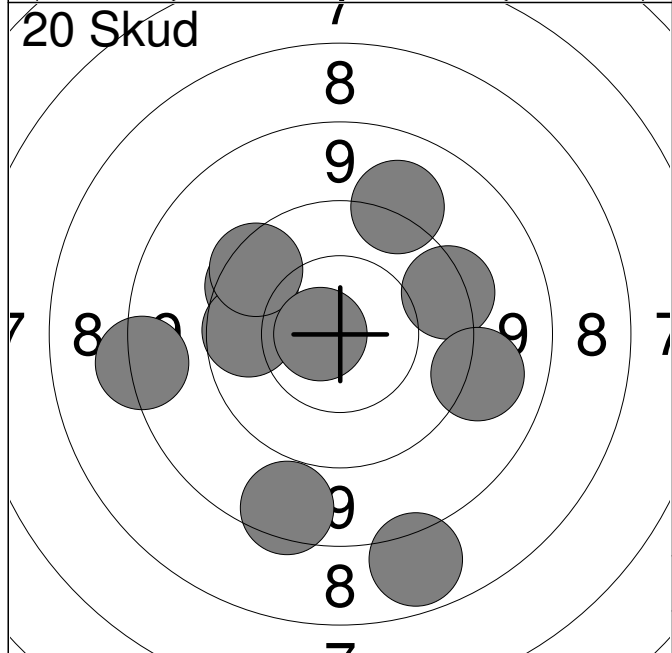

| | | |
|--------------|-------|-------------|
| 1: | 9.6 | → |
| 2: | 9.8 | ↖ |
| 3: | 9.3 | ↑ |
| 4: | 9.9 | ← |
| 5: | 9.2 | → |
| 6: | 8.0 | ↓ |
| 7: | 8.7 | ↓ |
| 8: | 8.5 | ← |
| 9: | 9.7 | ↗ |
| 10: | 10.7x | ← |
| Serie | | 88.0 |
| Total | | 88.0 |

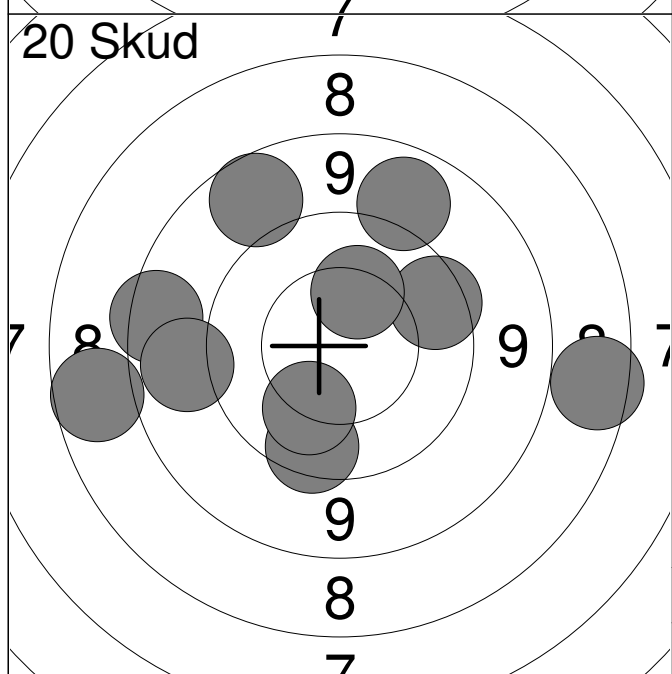

| | | |
|--------------|------|--------------|
| 11: | 8.7 | ← |
| 12: | 9.7 | → |
| 13: | 9.7 | ↓ |
| 14: | 10.3 | ↑ |
| 15: | 8.9 | ↗ |
| 16: | 10.1 | ↘ |
| 17: | 7.9 | ← |
| 18: | 9.1 | ↑ |
| 19: | 7.8 | → |
| 20: | 9.1 | ← |
| Serie | | 86.0 |
| Total | | 174.0 |

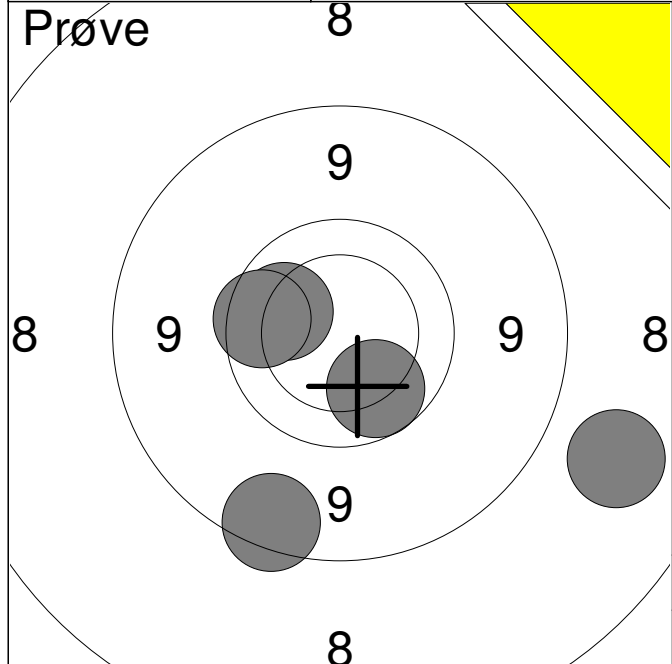

| | | |
|----|------|---|
| 1: | 9.9 | ↘ |
| 2: | 10.0 | ↗ |
| 3: | 8.2 | ↘ |
| 4: | 8.8 | ↘ |
| 5: | 9.8 | ↖ |

| | |
|--------------|-------------|
| Serie | 44.0 |
| Total | 0.0 |

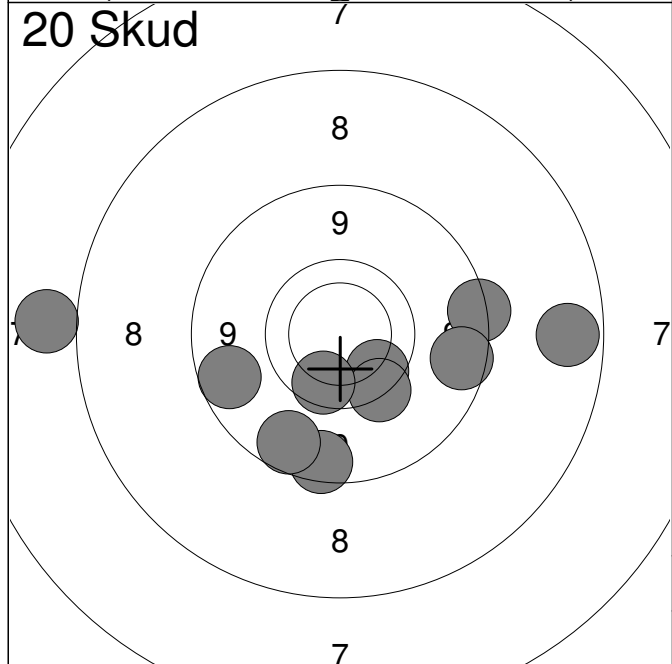

| | | |
|-----|-----|---|
| 1: | 8.9 | ↖ |
| 2: | 7.4 | ↖ |
| 3: | 9.8 | ↘ |
| 4: | 8.8 | ↘ |
| 5: | 8.7 | → |
| 6: | 9.6 | ↘ |
| 7: | 9.8 | ↘ |
| 8: | 8.9 | → |
| 9: | 8.9 | ↘ |
| 10: | 8.0 | → |

| | |
|--------------|-------------|
| Serie | 82.0 |
| Total | 82.0 |

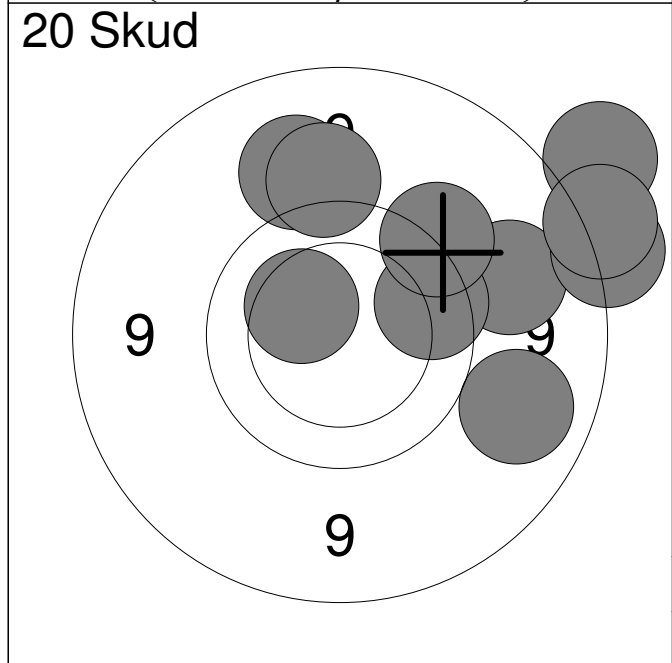

| | | |
|-----|------|---|
| 11: | 9.1 | → |
| 12: | 9.3 | ↗ |
| 13: | 9.2 | → |
| 14: | 9.8 | → |
| 15: | 8.4 | ↗ |
| 16: | 9.5 | ↗ |
| 17: | 8.6 | → |
| 18: | 9.4 | ↗ |
| 19: | 10.3 | ↖ |
| 20: | 8.6 | → |

| | |
|--------------|--------------|
| Serie | 88.0 |
| Total | 170.0 |

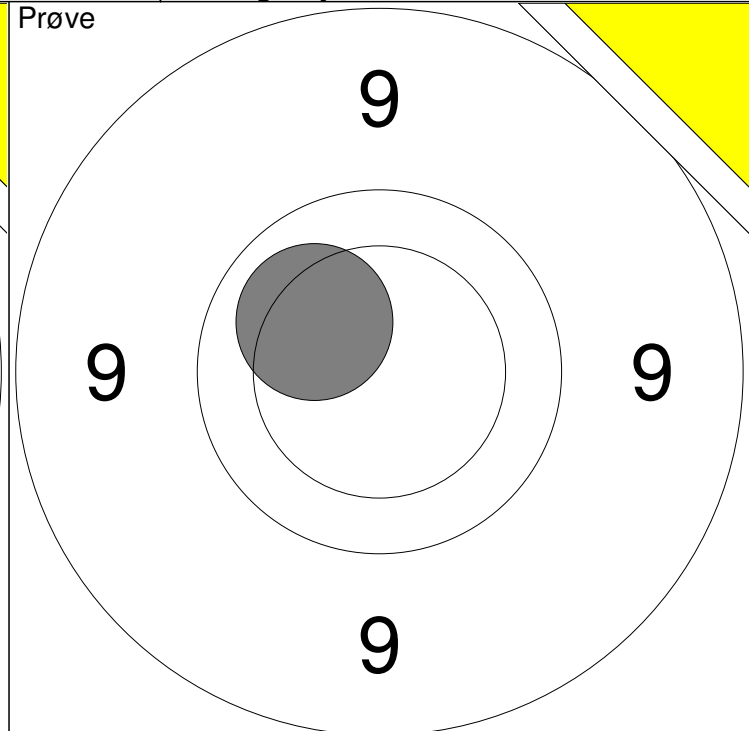
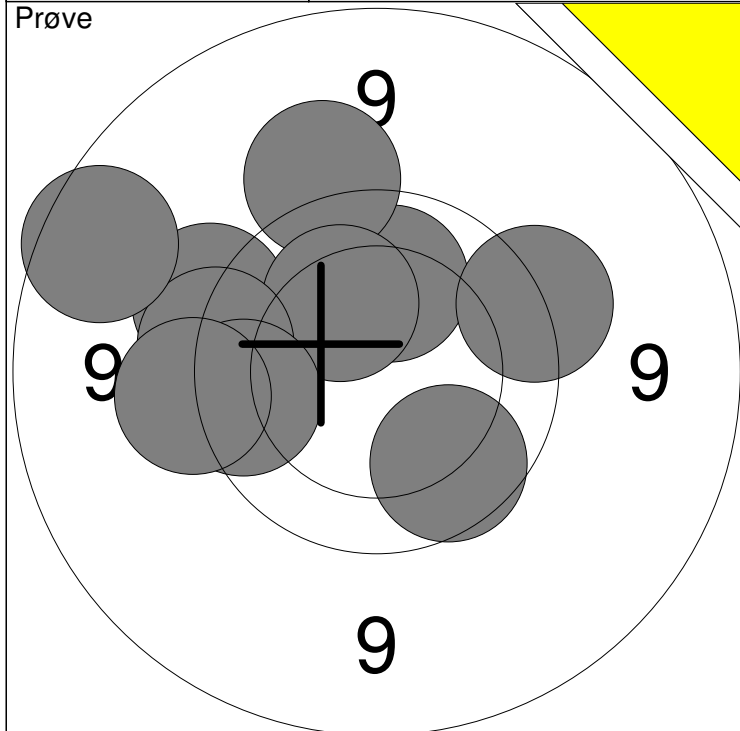

| | | | |
|-----------|-----------|-------|----|
| 1: 10.1 ↑ | 6: 8.9 ↖ | Serie | 91 |
| 2: 9.5 ↖ | 7: 9.8 ← | | |
| 3: 9.4 ↑ | 8: 9.5 ← | Total | 0 |
| 4: 10.2 ↗ | 9: 9.9 ↘ | | |
| 5: 9.6 ← | 10: 9.6 ↗ | | |

| | | |
|------------|-------|----|
| 11: 10.2 ↖ | Serie | 10 |
| | | |
| | Total | 0 |
| | | |

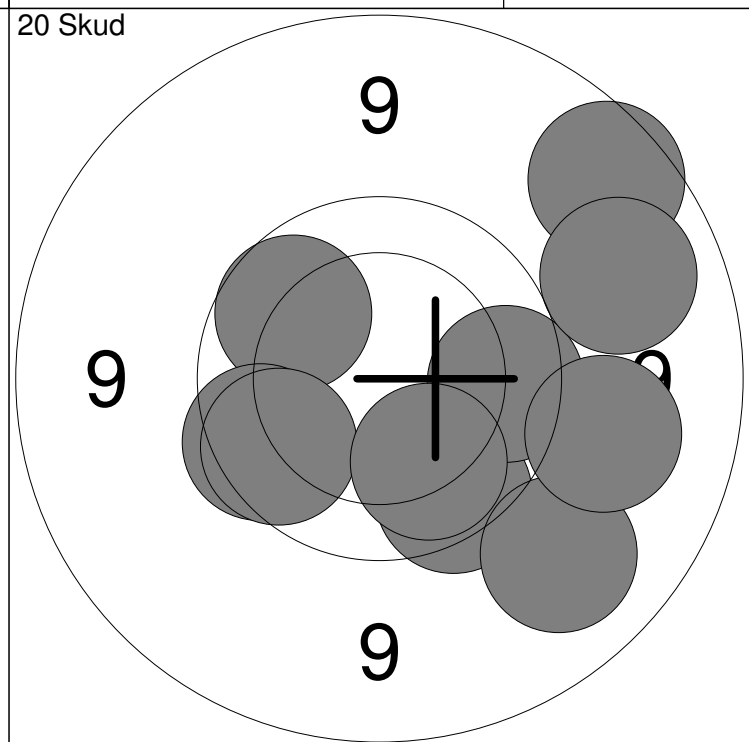
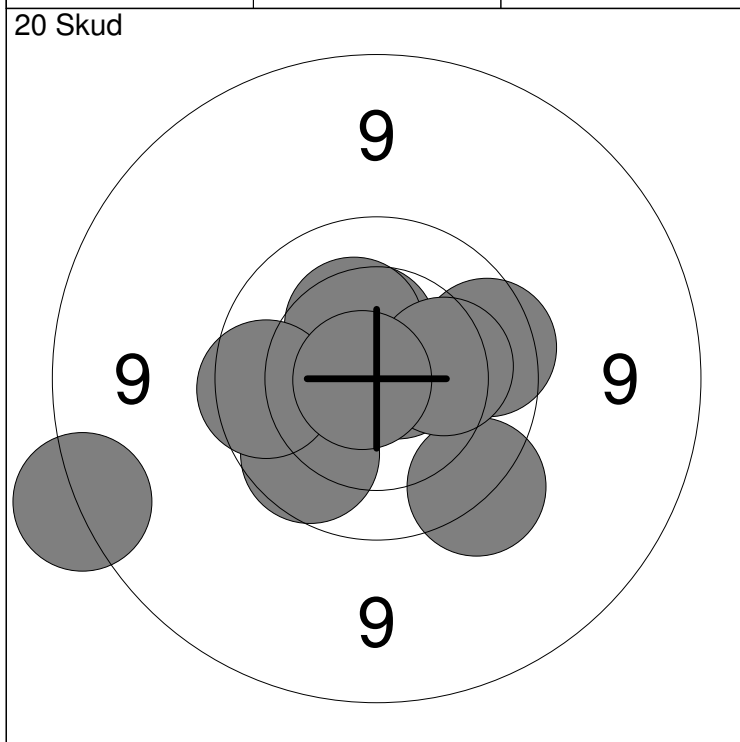

| | | | |
|------------|------------|-------|----|
| 1: 9.6 ↘ | 6: 10.3 ↗ | Serie | 94 |
| 2: 10.7x ↗ | 7: 10.2 → | | |
| 3: 9.9 ↙ | 8: 9.8 ← | Total | 94 |
| 4: 9.8 → | 9: 10.8x ← | | |
| 5: 10.5 ↑ | 10: 8.7 ← | | |

| | | | |
|-----------|------------|-------|-----|
| 11: 9.8 ↘ | 16: 9.8 ← | Serie | 90 |
| 12: 9.8 → | 17: 9.9 ↙ | | |
| 13: 8.9 ↗ | 18: 9.1 ↘ | Total | 184 |
| 14: 9.9 ↖ | 19: 9.3 → | | |
| 15: 9.1 ↗ | 20: 10.0 ↘ | | |

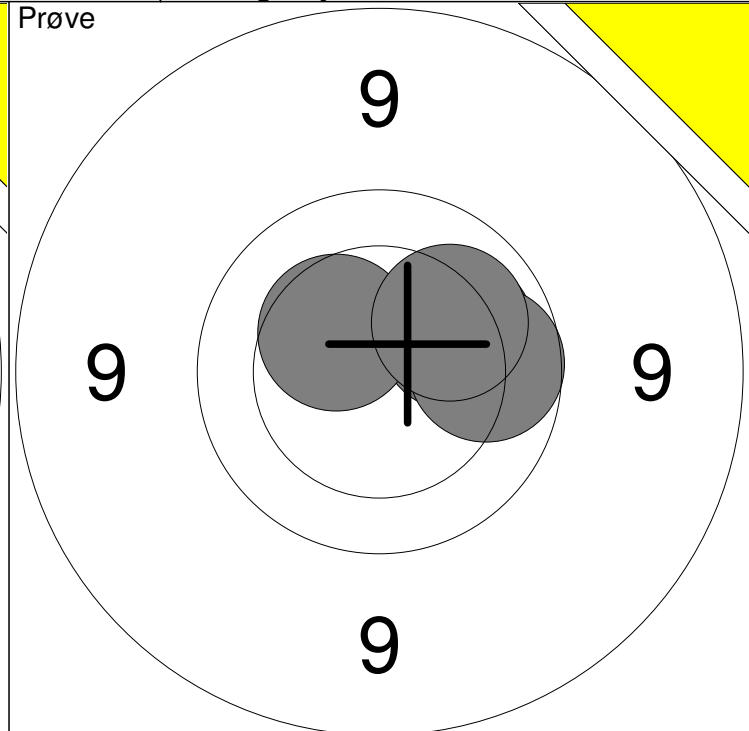
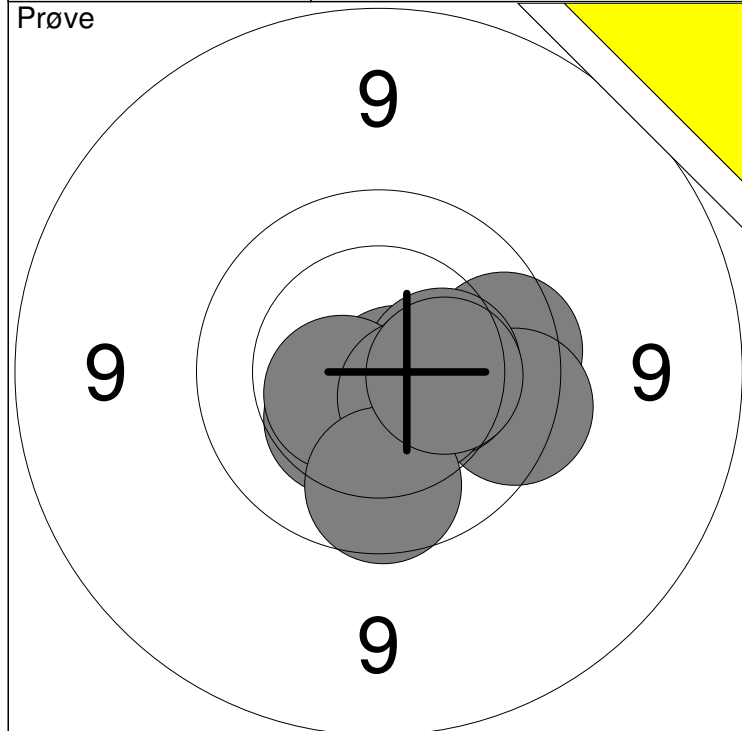

| | | | |
|------------|------------|--------------|----|
| 1: 9.8 → | 6: 10.3 → | Serie | 97 |
| 2: 9.7 → | 7: 10.5x ↙ | | |
| 3: 10.7x ↘ | 8: 10.5x ↘ | Total | 0 |
| 4: 10.3 → | 9: 9.9 ↓ | | |
| 5: 10.4 ↙ | 10: 10.3 → | | |

| | | |
|------------|--------------|----|
| 11: 10.1 ↗ | Serie | 39 |
| 12: 9.9 → | | |
| 13: 10.4 ↖ | Total | 0 |
| 14: 10.1 ↗ | | |

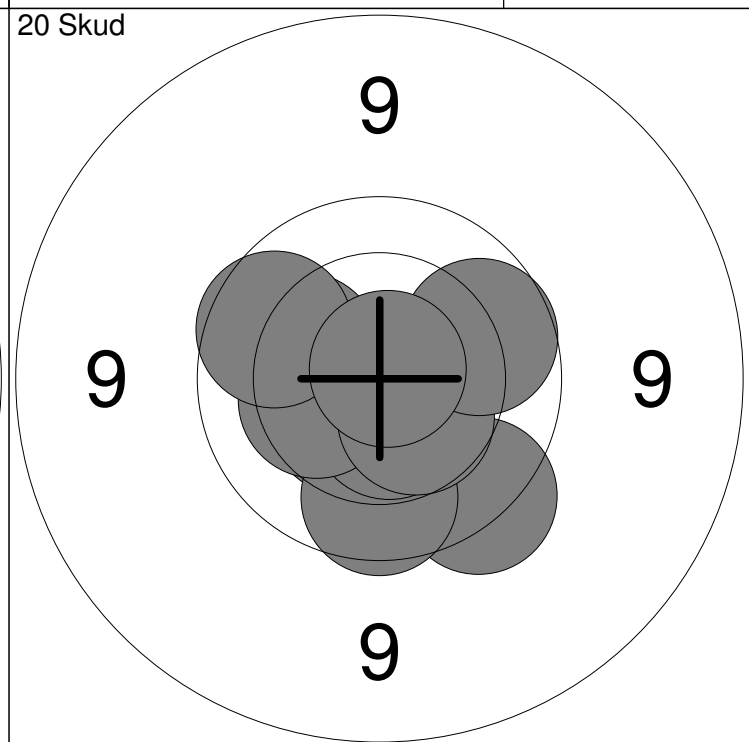
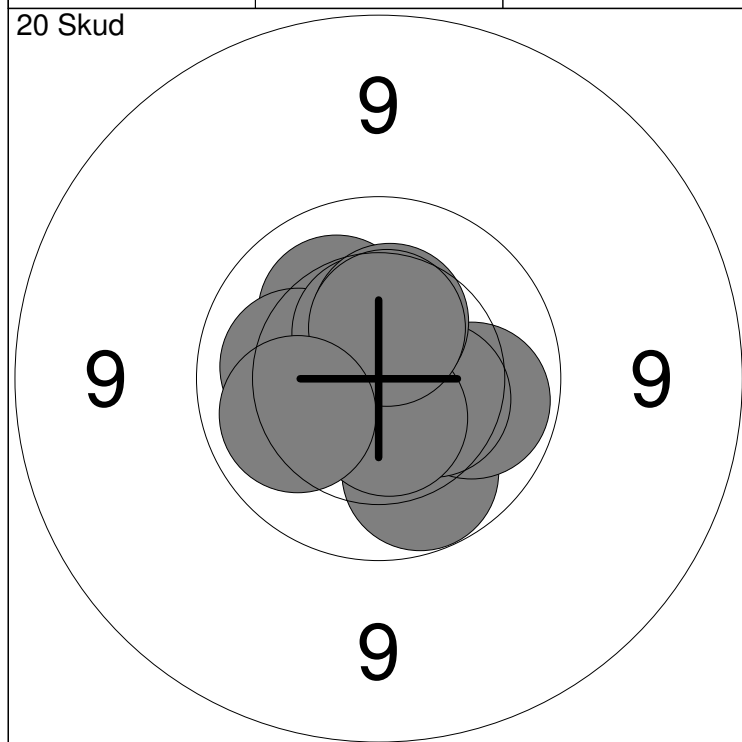

| | | | |
|-----------|------------|--------------|-----|
| 1: 10.0 ↘ | 6: 10.5x ↑ | Serie | 100 |
| 2: 10.0 → | 7: 10.4 ↑ | | |
| 3: 10.2 ↗ | 8: 10.6x ↘ | Total | 100 |
| 4: 10.2 ↖ | 9: 10.5 ↑ | | |
| 5: 10.4 ↘ | 10: 10.1 ↖ | | |

| | | | |
|-------------|-------------|--------------|-----|
| 11: 10.5 ↙ | 16: 10.3 ↖ | Serie | 96 |
| 12: 10.2 ↖ | 17: 9.9 ↖ | | |
| 13: 9.7 ↘ | 18: 10.4 ↘ | Total | 196 |
| 14: 9.9 ↓ | 19: 9.9 ↗ | | |
| 15: 10.5x ↘ | 20: 10.8x ↗ | | |

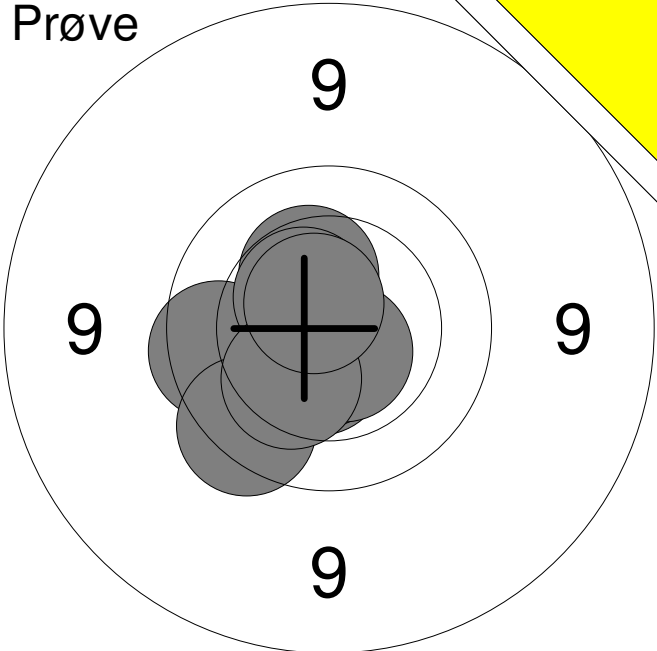
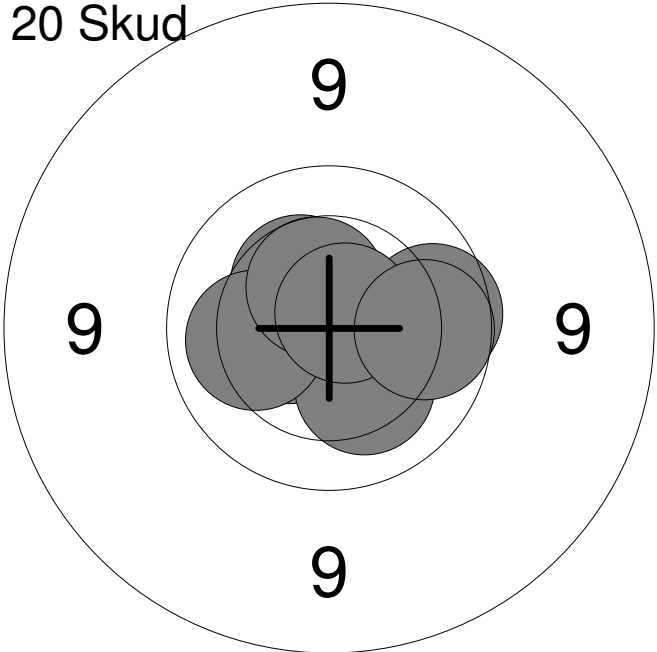
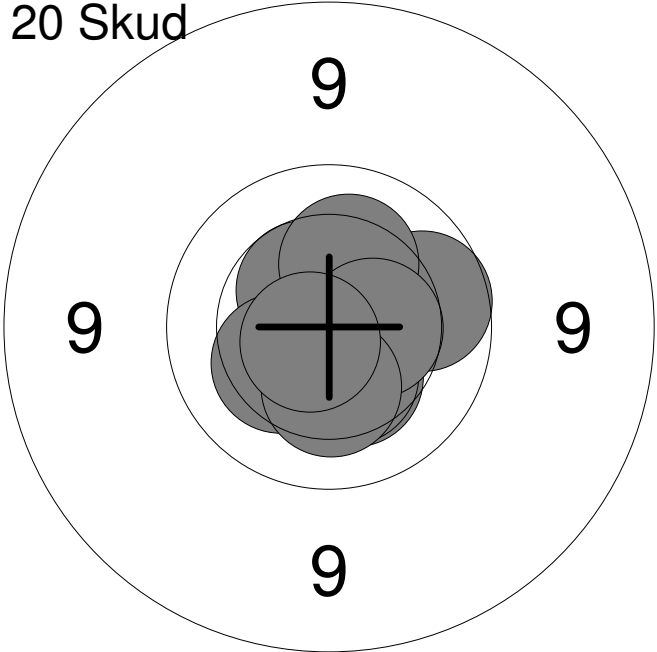
| Hold | Skive | Michael Brasch | |
|--|---------------------------------|---------------------|-------------|
| 26 | 9 | | |
| 15m | Midtdjurs Skytteforening | MÅ1 | |
| | 15 meter riffelstævne oktober 2 | Aalborg Skyttekreds | |
| Prøve  | 1: | 10.6x | ↙ |
| | 2: | 9.8 | ← |
| | 3: | 10.3 | ↑ |
| | 4: | 9.7 | ↙ |
| | 5: | 10.5x | ↙ |
| | 6: | 10.5x | ↗ |
| | 7: | 10.6x | ↙ |
| | 8: | 10.7x | ↙ |
| | 9: | 10.3 | ↙ |
| | 10: | 10.6x | ↗ |
| | Serie | | 98.0 |
| Total | | 0.0 | |
| 20 Skud  | 1: | 10.5x | ↖ |
| | 2: | 9.9 | → |
| | 3: | 10.5x | ← |
| | 4: | 10.7x | ↗ |
| | 5: | 10.4 | ↗ |
| | 6: | 10.2 | ↙ |
| | 7: | 10.1 | ← |
| | 8: | 10.5x | ↗ |
| | 9: | 10.7x | ↗ |
| | 10: | 9.9 | → |
| | Serie | | 98.0 |
| Total | | 98.0 | |
| 20 Skud  | 11: | 10.5 | ↗ |
| | 12: | 10.3 | ↙ |
| | 13: | 10.4 | ↙ |
| | 14: | 9.9 | → |
| | 15: | 10.6x | → |
| | 16: | 10.3 | ↙ |
| | 17: | 10.2 | ↑ |
| | 18: | 10.5 | → |
| | 19: | 10.3 | ↙ |
| | 20: | 10.7x | ↙ |
| | Serie | | 99.0 |
| Total | | 197.0 | |

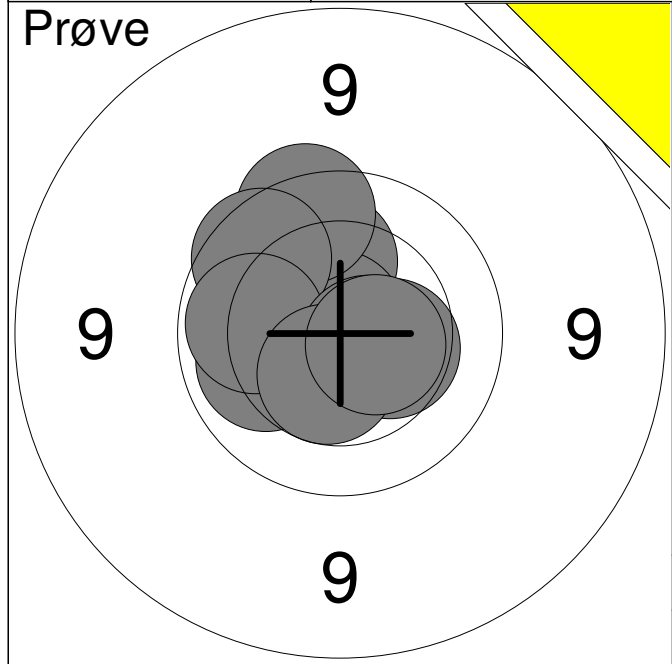

| | | |
|-----|-------|---|
| 1: | 10.1 | ← |
| 2: | 10.2 | ↑ |
| 3: | 10.8x | ↑ |
| 4: | 9.8 | ↑ |
| 5: | 9.9 | ↑ |
| 6: | 10.0 | ← |
| 7: | 10.6x | ↓ |
| 8: | 10.4 | → |
| 9: | 10.5 | ↓ |
| 10: | 10.5x | → |

| | |
|-------|------|
| Serie | 98.0 |
| Total | 0.0 |

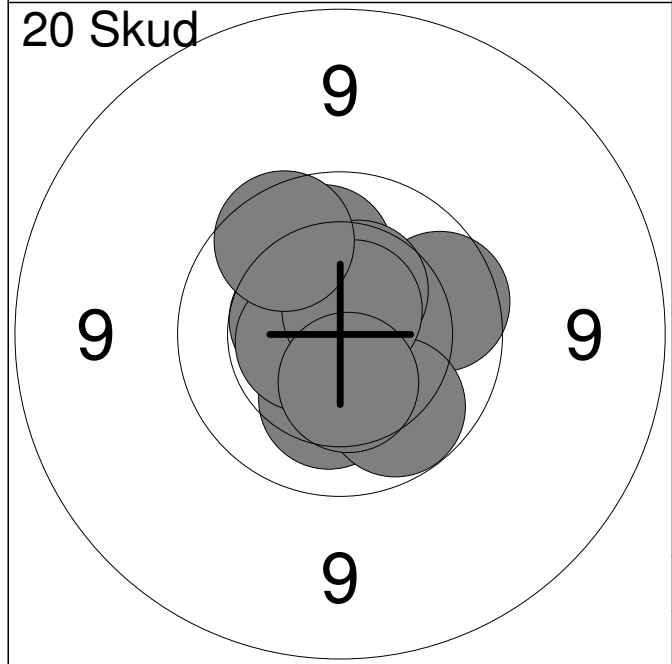

| | | |
|-----|-------|---|
| 1: | 10.1 | ↑ |
| 2: | 10.2 | ↓ |
| 3: | 9.9 | → |
| 4: | 10.5 | ← |
| 5: | 10.4 | ↑ |
| 6: | 10.0 | ↓ |
| 7: | 10.6x | ← |
| 8: | 10.7x | ↑ |
| 9: | 10.4 | ↓ |
| 10: | 9.9 | ↑ |

| | |
|-------|------|
| Serie | 98.0 |
| Total | 98.0 |

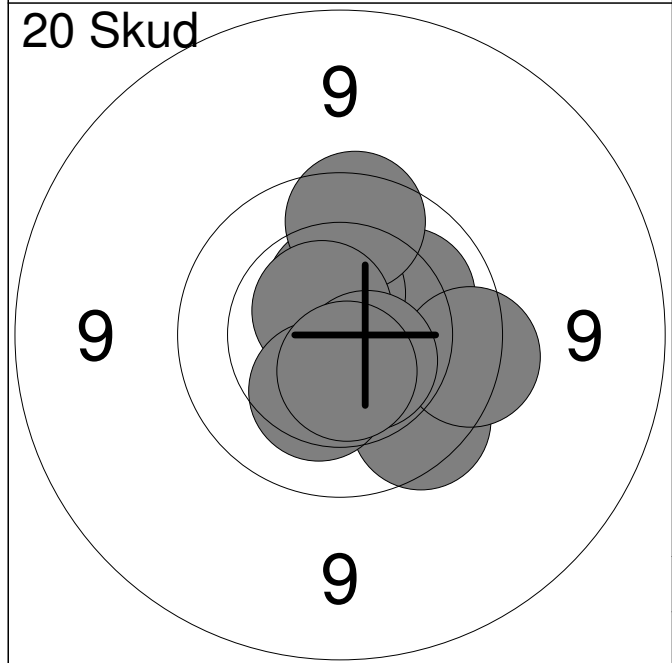

| | | |
|-----|-------|---|
| 11: | 10.2 | ↑ |
| 12: | 9.8 | ↓ |
| 13: | 10.1 | → |
| 14: | 10.5x | ↑ |
| 15: | 9.7 | → |
| 16: | 9.8 | ↑ |
| 17: | 10.6x | ↑ |
| 18: | 10.3 | ↓ |
| 19: | 10.5x | ↓ |
| 20: | 10.6x | ↓ |

| | |
|-------|-------|
| Serie | 97.0 |
| Total | 195.0 |

| Hold | Skive | Henrik Møller Jakobsen | | |
|---------|---------------------------------|------------------------|---------------------|------|
| 26 | 11 | Vester Hassing Skf. | ÅK3 | |
| 15m | 15 meter riffelstævne oktober 2 | | Aalborg Skyttekreds | |
| Prøve | | 1: | 10.1 | ↗ |
| | | 2: | 10.5x | ↗ |
| | | 3: | 9.2 | ↗ |
| | | 4: | 9.3 | ↗ |
| | | 5: | 9.5 | ↗ |
| | | 6: | 9.2 | ↖ |
| | | 7: | 10.3 | ↗ |
| | | 8: | 10.4 | ↘ |
| | | 9: | 10.5x | → |
| | | Serie | | 86.0 |
| Total | | 0.0 | | |
| 20 Skud | | 1: | 10.5x | → |
| | | 2: | 9.5 | → |
| | | 3: | 9.8 | → |
| | | 4: | 10.0 | ↘ |
| | | 5: | 9.5 | ↖ |
| | | 6: | 10.8x | ↗ |
| | | 7: | 10.3 | ↗ |
| | | 8: | 10.5 | ↗ |
| | | 9: | 9.8 | → |
| | | 10: | 10.3 | ↗ |
| Serie | | 96.0 | | |
| Total | | 96.0 | | |
| 20 Skud | | 11: | 9.9 | ↘ |
| | | 12: | 10.4 | ↖ |
| | | 13: | 9.1 | ↗ |
| | | 14: | 9.9 | ↘ |
| | | 15: | 9.9 | ↘ |
| | | 16: | 10.8x | ↖ |
| | | 17: | 10.3 | → |
| | | 18: | 10.3 | → |
| | | 19: | 10.2 | ↘ |
| | | 20: | 8.8 | ↖ |
| Serie | | 94.0 | | |
| Total | | 190.0 | | |

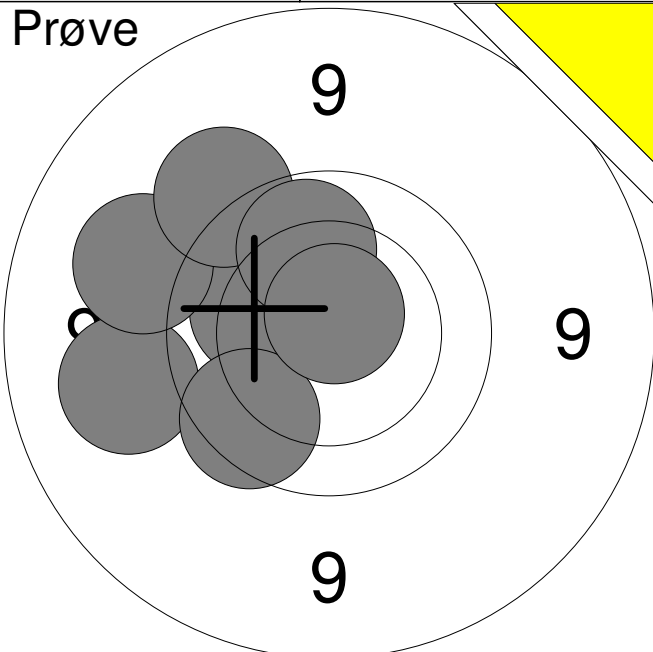
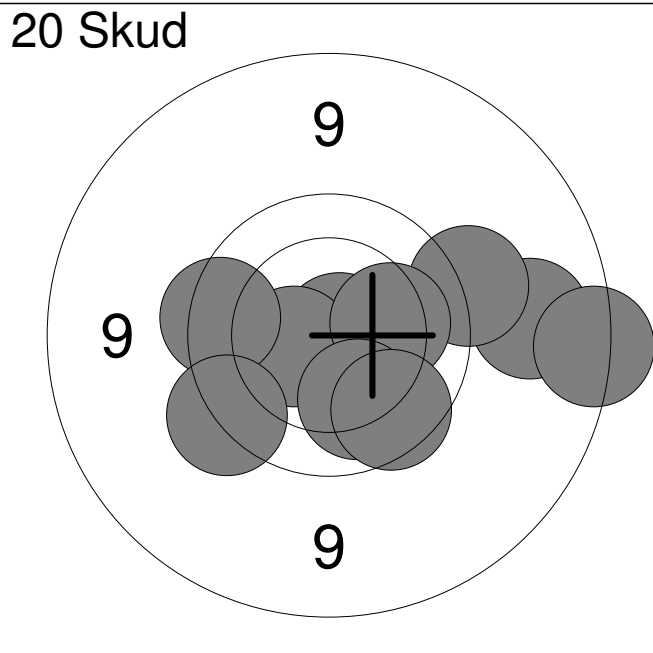
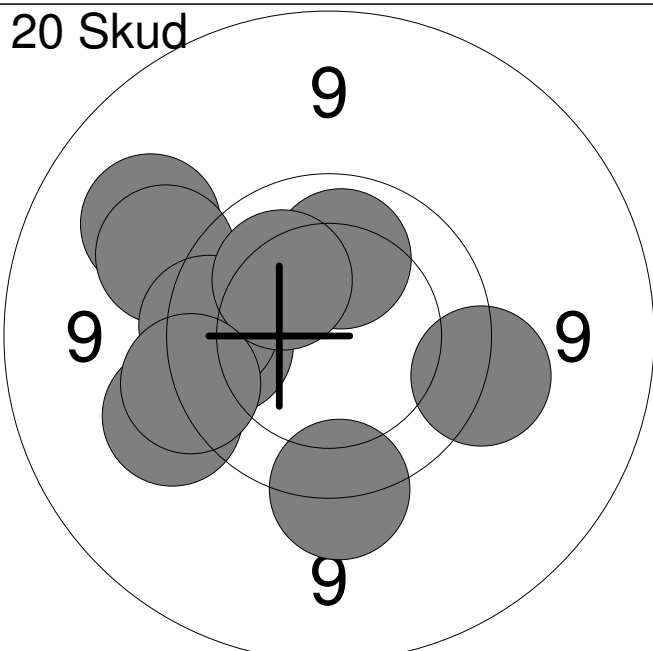
| Hold | Skive | Torben Klit Andersen | |
|---------|--|----------------------|---|
| 26 | 12 | | |
| 15m | Vester Hassing Skf. | M2 | |
| | 15 meter riffelstævne oktober 2 | Aalborg Skyttekreds | |
| Prøve |  | 1: 9.2 | ← |
| | | 2: 10.2 | ↖ |
| | | 3: 9.3 | ↖ |
| | | 4: 9.8 | ↖ |
| | | 5: 9.5 | ↗ |
| | | 6: 10.0 | ↗ |
| | | 7: 10.7x | ↗ |
| | Serie | 66.0 | |
| | Total | 0.0 | |
| 20 Skud |  | 1: 9.1 | → |
| | | 2: 10.8x | → |
| | | 3: 8.8 | → |
| | | 4: 9.5 | → |
| | | 5: 10.5x | ← |
| | | 6: 9.7 | ← |
| | | 7: 10.2 | → |
| | | 8: 10.1 | ↓ |
| | | 9: 9.6 | ↙ |
| | | 10: 9.8 | ↓ |
| | Serie | 93.0 | |
| | Total | 93.0 | |
| 20 Skud |  | 11: 9.2 | ↖ |
| | | 12: 9.4 | ↖ |
| | | 13: 9.9 | ↖ |
| | | 14: 9.4 | ↗ |
| | | 15: 9.6 | → |
| | | 16: 10.1 | ↗ |
| | | 17: 9.6 | ↓ |
| | | 18: 9.8 | ↖ |
| | | 19: 10.2 | ↗ |
| | | 20: 9.6 | ↖ |
| | Serie | 92.0 | |
| | Total | 185.0 | |

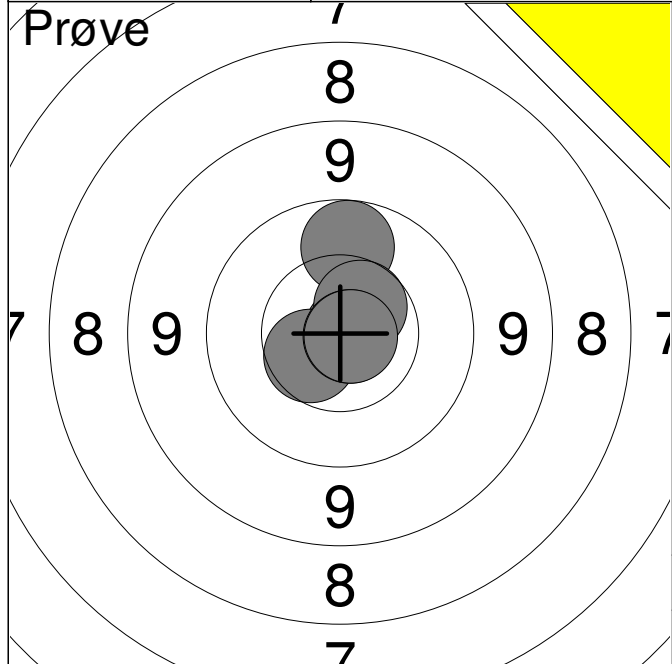

| | | |
|----|-------|---|
| 1: | 10.8x | → |
| 2: | 9.9 | ↑ |
| 3: | 10.6 | ↗ |
| 4: | 10.5 | ↖ |
| 5: | 10.8x | → |
| 6: | 10.8x | → |

| | |
|--------------|-------------|
| Serie | 59.0 |
| Total | 0.0 |

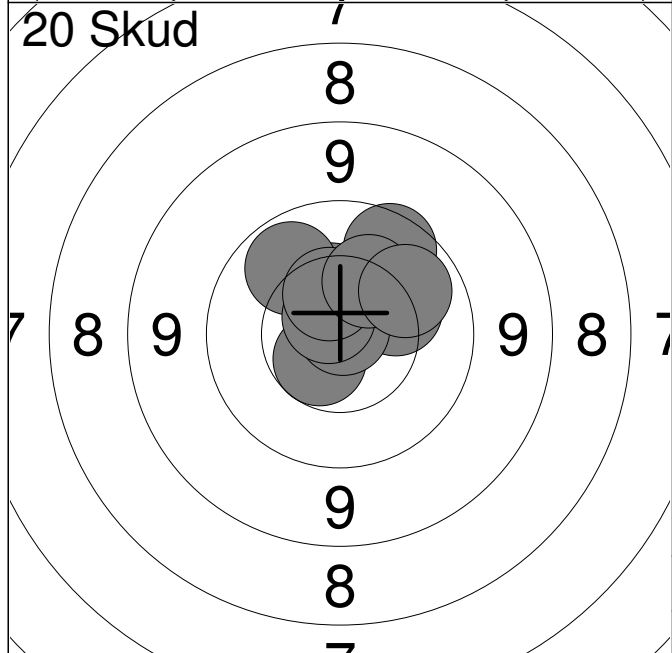

| | | |
|-----|-------|---|
| 1: | 10.6 | ↖ |
| 2: | 9.8 | ↗ |
| 3: | 10.4 | ↑ |
| 4: | 10.0 | ↗ |
| 5: | 10.2 | → |
| 6: | 10.9x | ↑ |
| 7: | 10.7x | ↗ |
| 8: | 10.5 | ↑ |
| 9: | 10.3 | ↗ |
| 10: | 10.0 | ↗ |

| | |
|--------------|-------------|
| Serie | 99.0 |
| Total | 99.0 |

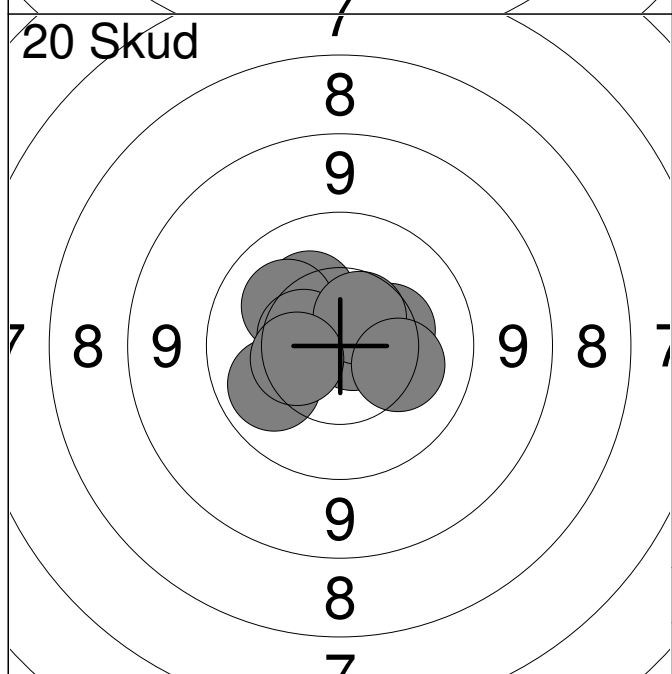

| | | |
|-----|-------|---|
| 11: | 10.7x | ↗ |
| 12: | 10.3 | ↗ |
| 13: | 10.8x | → |
| 14: | 10.2 | ↗ |
| 15: | 10.5 | ↖ |
| 16: | 10.1 | ↖ |
| 17: | 10.4 | → |
| 18: | 10.6 | ↗ |
| 19: | 10.2 | → |
| 20: | 10.4 | ← |

| | |
|--------------|--------------|
| Serie | 100.0 |
| Total | 199.0 |

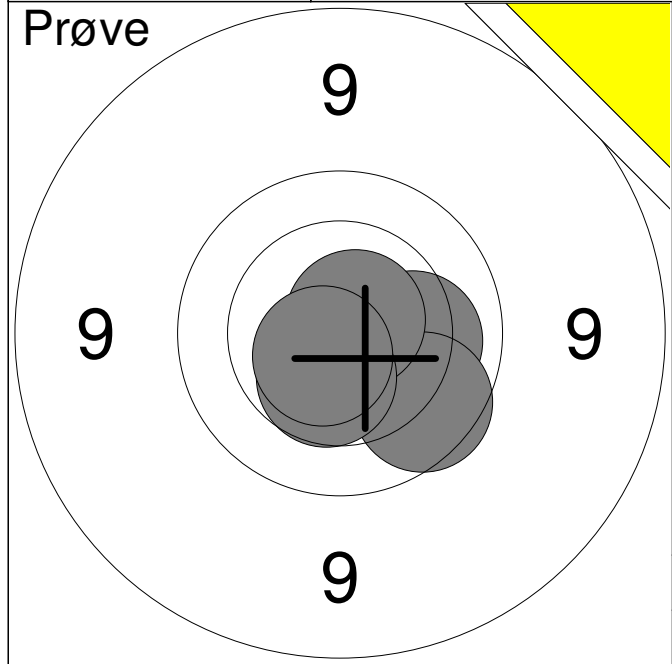

| | | |
|--------------|-------|-------------|
| 1: | 10.2 | → |
| 2: | 9.9 | ↘ |
| 3: | 10.7x | ↗ |
| 4: | 10.4 | ↓ |
| 5: | 10.6x | ↙ |
| Serie | | 49.0 |
| Total | | 0.0 |

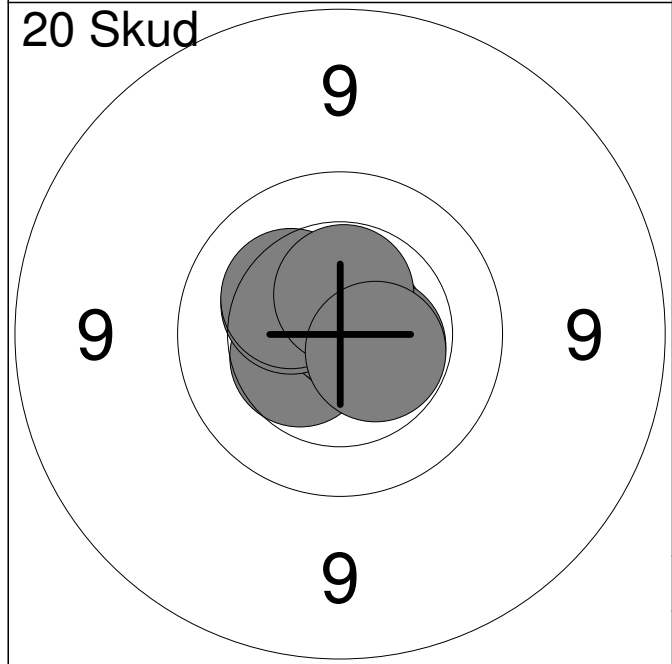

| | | |
|--------------|-------|--------------|
| 1: | 10.5x | ↖ |
| 2: | 10.7x | ↙ |
| 3: | 10.5 | ↙ |
| 4: | 10.8x | ↗ |
| 5: | 10.5x | → |
| 6: | 10.8x | ↗ |
| 7: | 10.3 | ↗ |
| 8: | 10.3 | ↗ |
| 9: | 10.5x | ↑ |
| 10: | 10.5x | ↘ |
| Serie | | 100.0 |
| Total | | 100.0 |

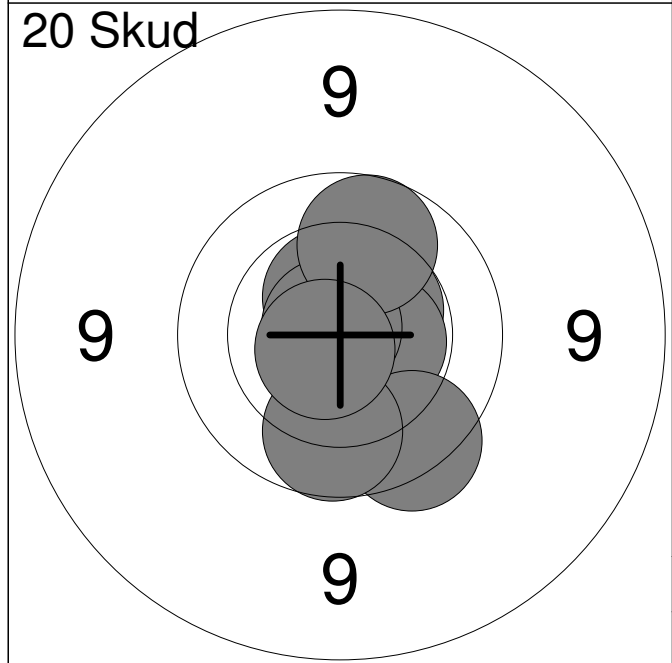

| | | |
|--------------|-------|--------------|
| 11: | 10.6x | ↑ |
| 12: | 10.5x | ↗ |
| 13: | 10.7x | ↗ |
| 14: | 10.5x | ↑ |
| 15: | 10.6x | → |
| 16: | 9.7 | ↓ |
| 17: | 10.8x | ↗ |
| 18: | 9.9 | ↑ |
| 19: | 9.9 | ↓ |
| 20: | 10.7x | ↙ |
| Serie | | 97.0 |
| Total | | 197.0 |

Prøve

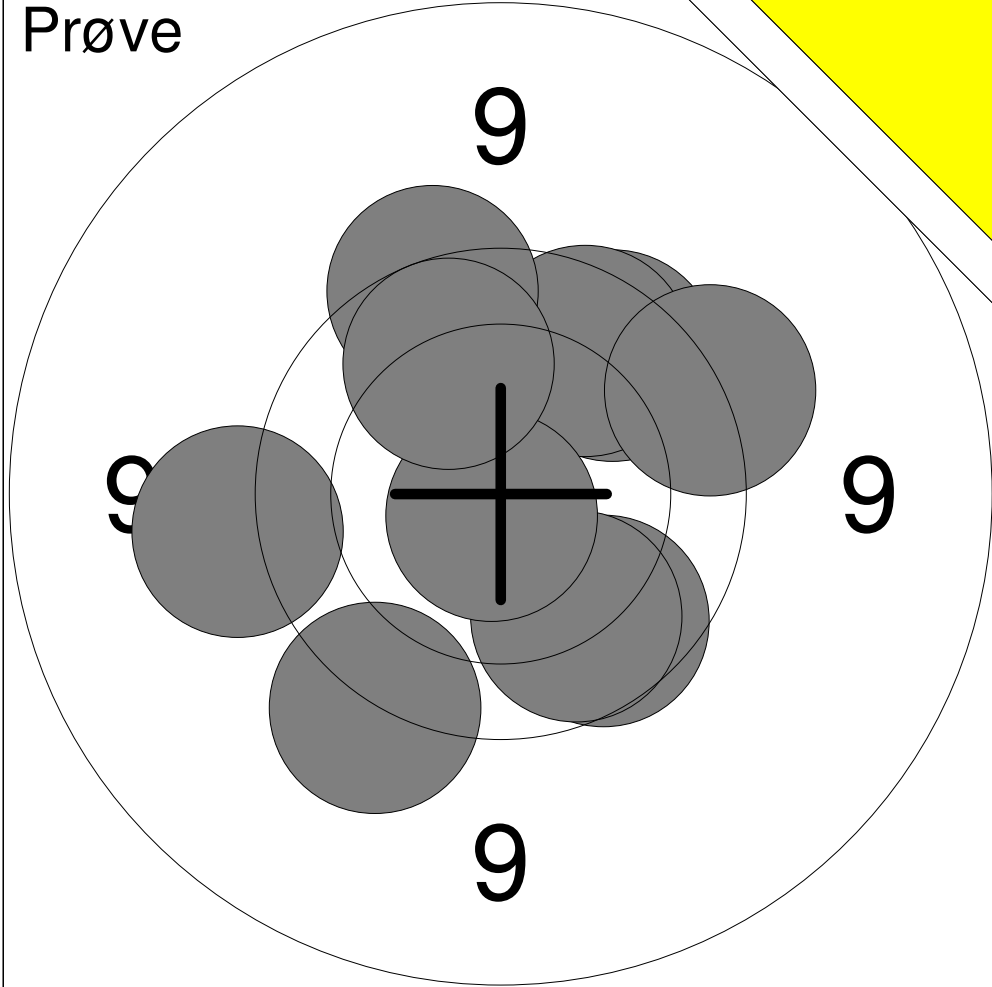

| | | |
|-----|-------|---|
| 1: | 9.8 | ↗ |
| 2: | 9.9 | ↘ |
| 3: | 9.9 | ↘ |
| 4: | 9.8 | ↗ |
| 5: | 9.6 | ↗ |
| 6: | 9.6 | ↗ |
| 7: | 10.8x | ↘ |
| 8: | 9.9 | ↗ |
| 9: | 9.4 | ↖ |
| 10: | 9.5 | ↘ |

Serie 91.0

Total 0.0

20 Skud

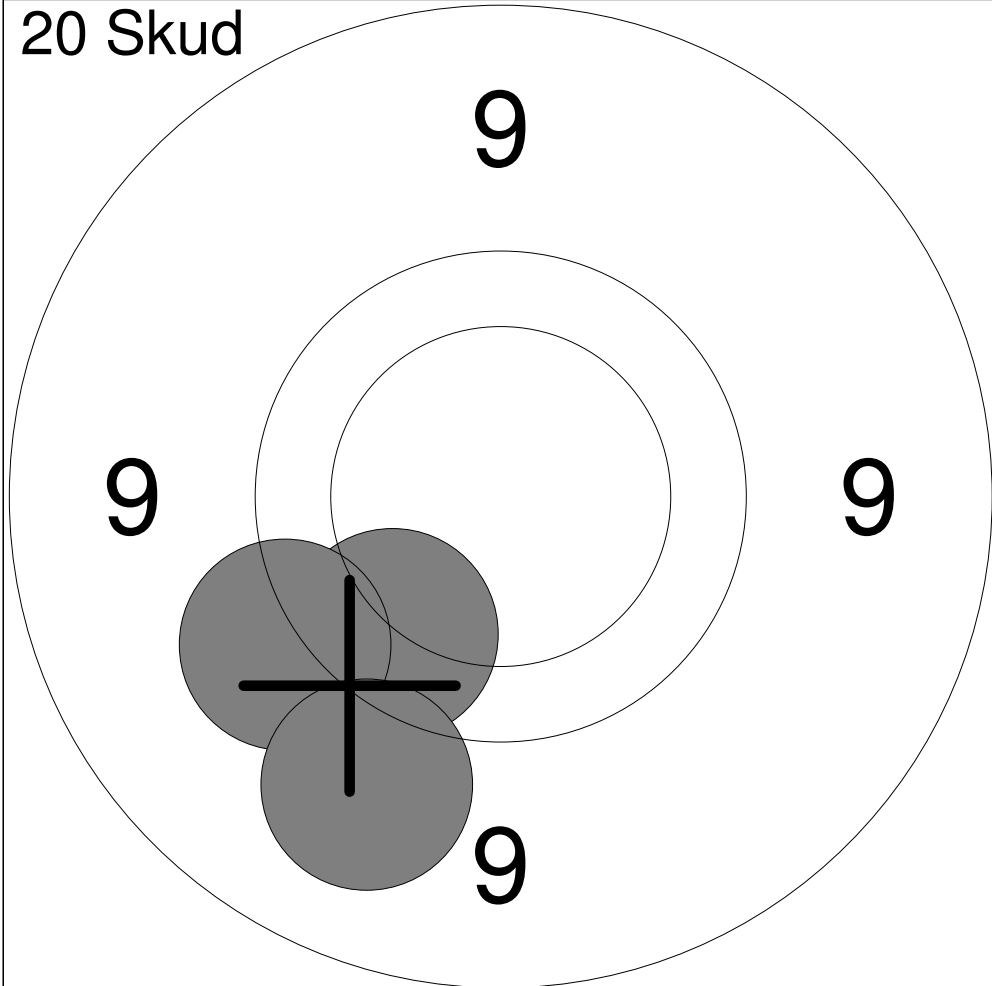

| | | |
|----|-----|---|
| 1: | 9.8 | ↘ |
| 2: | 9.5 | ↖ |
| 3: | 9.2 | ↘ |

Serie 27.0

Total 27.0

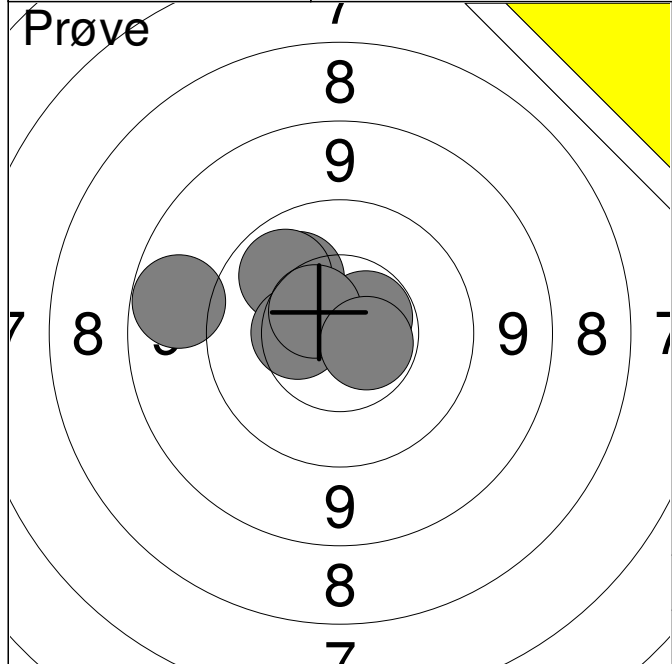

| | | |
|--------------|-------|-------------|
| 1: | 10.1 | ↗ |
| 2: | 10.0 | ↗ |
| 3: | 10.5 | ← |
| 4: | 10.6x | ↗ |
| 5: | 10.6 | ↗ |
| 6: | 9.0 | ← |
| 7: | 10.6x | ↘ |
| Serie | | 69.0 |
| Total | | 0.0 |

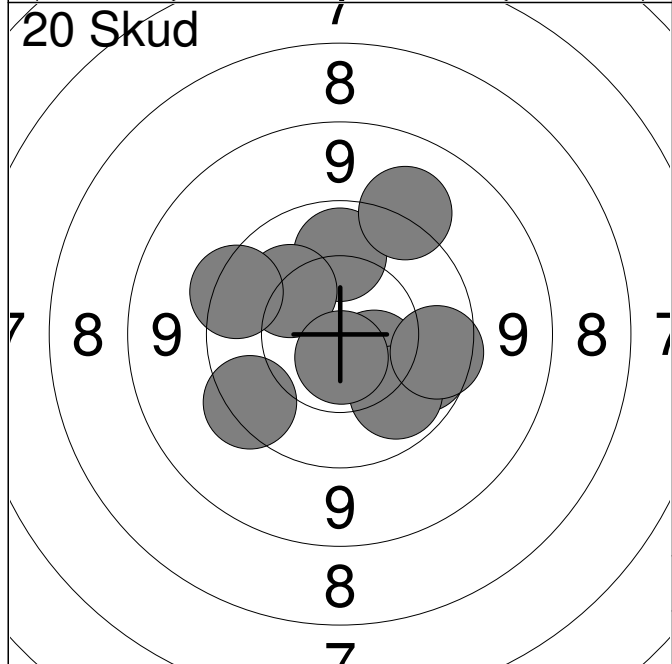

| | | |
|--------------|-------|-------------|
| 1: | 10.0 | ↑ |
| 2: | 9.9 | ↘ |
| 3: | 10.5 | ↘ |
| 4: | 10.2 | ↗ |
| 5: | 10.0 | ↘ |
| 6: | 9.8 | → |
| 7: | 10.7x | ↓ |
| 8: | 9.6 | ↙ |
| 9: | 9.3 | ↗ |
| 10: | 9.6 | ↙ |
| Serie | | 95.0 |
| Total | | 95.0 |

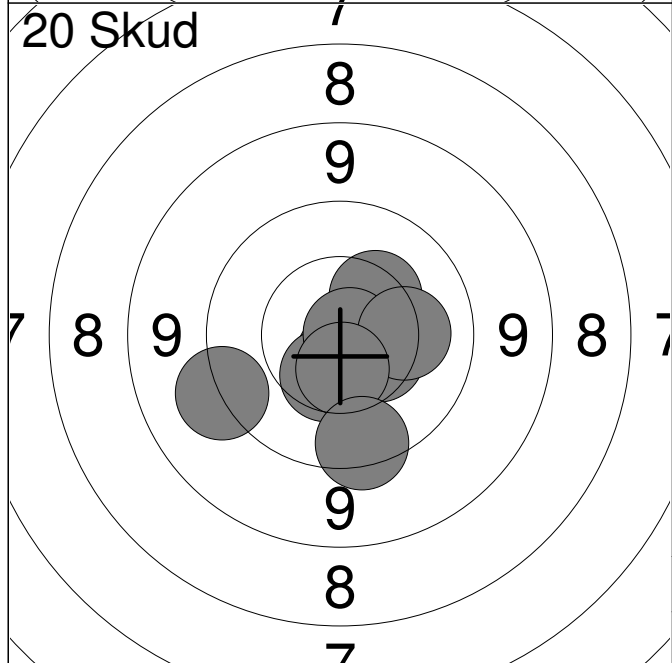

| | | |
|--------------|-------|--------------|
| 11: | 9.4 | ↙ |
| 12: | 10.4 | → |
| 13: | 10.7x | ↓ |
| 14: | 10.5 | ↘ |
| 15: | 10.5 | ↘ |
| 16: | 10.3 | ↗ |
| 17: | 10.8x | → |
| 18: | 10.2 | → |
| 19: | 10.6 | ↓ |
| 20: | 9.6 | ↓ |
| Serie | | 98.0 |
| Total | | 193.0 |

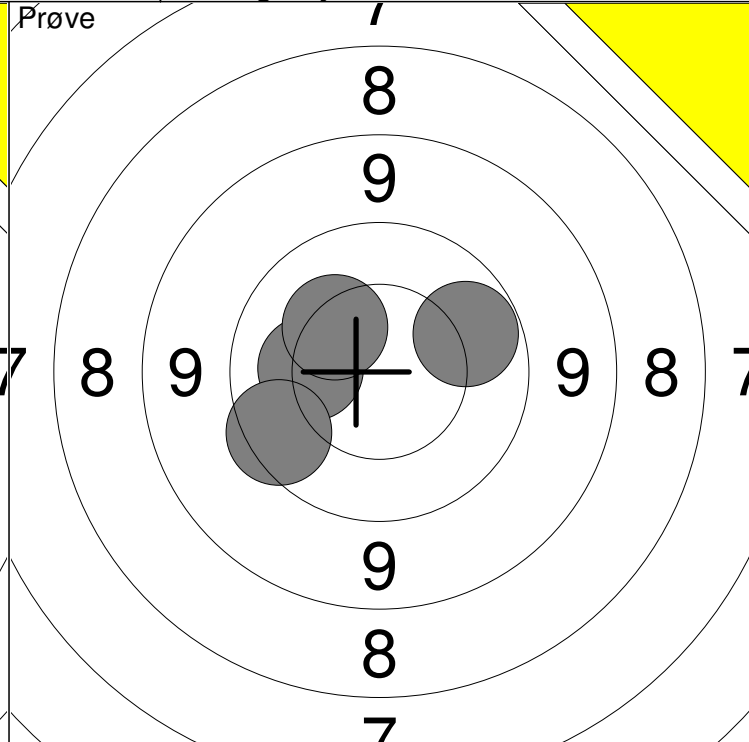
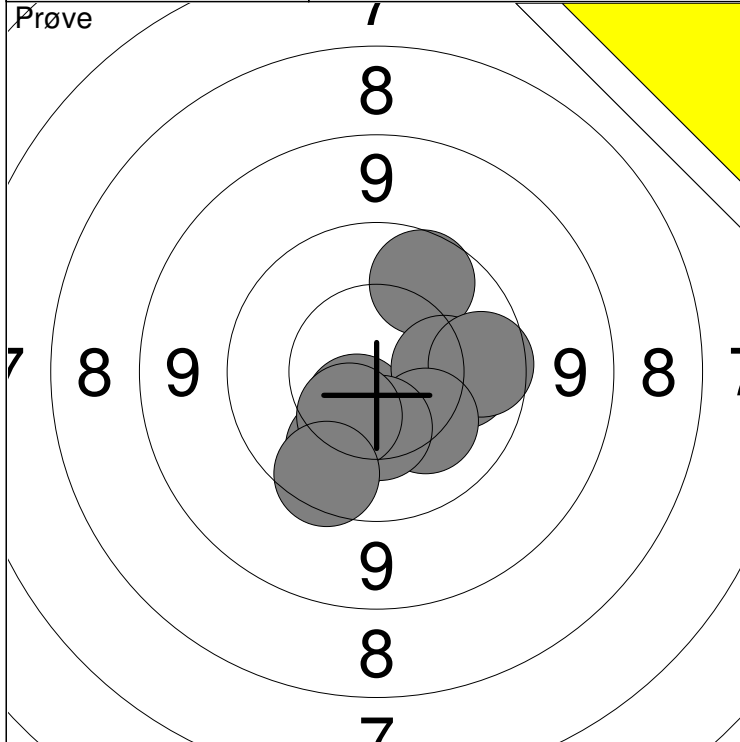

| | | | |
|-----------|-----------|-------------|--|
| 1: 10.1 → | 6: 9.9 → | Serie 97 | |
| 2: 10.5 ↘ | 7: 10.2 ↘ | | |
| 3: 10.1 ↘ | 8: 10.4 ↓ | Total 0 | |
| 4: 9.9 ↗ | 9: 10.4 ↘ | | |
| 5: 10.3 → | 10: 9.8 ↘ | | |

| | | |
|------------|-------------|--|
| 11: 10.2 ← | Serie 39 | |
| 12: 9.7 ↙ | | |
| 13: 10.0 ↗ | Total 0 | |
| 14: 10.3 ↖ | | |

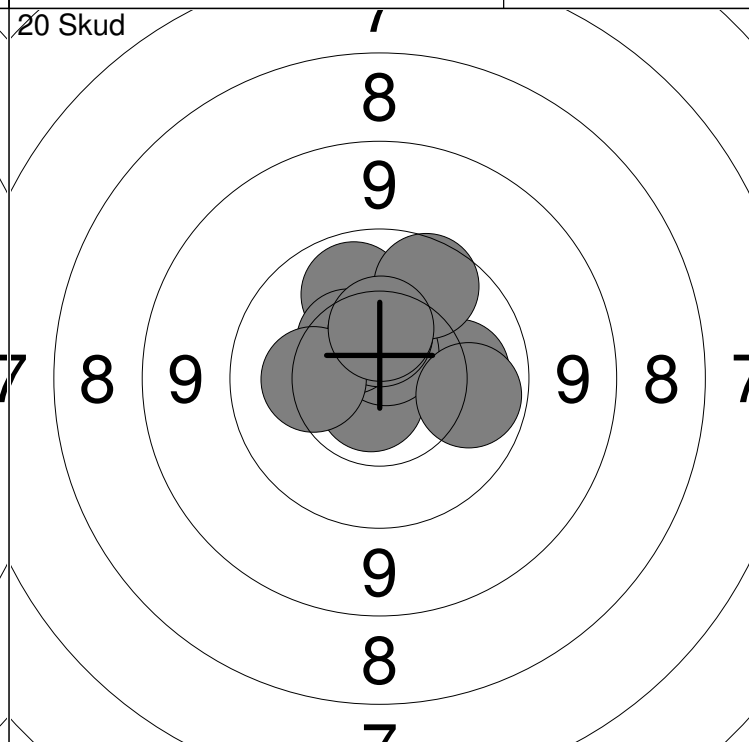
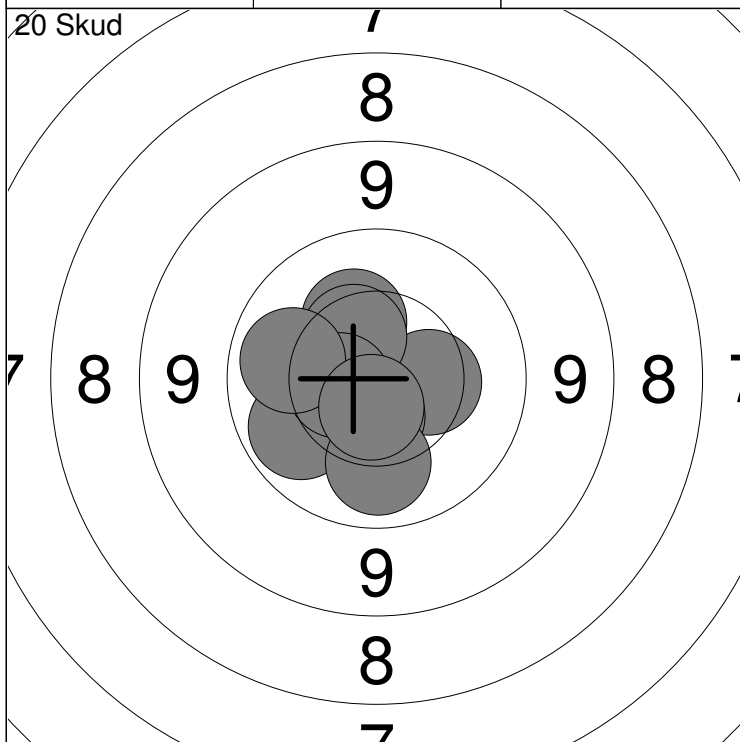

| | | | |
|-----------|-------------|--------------|--|
| 1: 10.4 → | 6: 10.0 ↖ | Serie 100 | |
| 2: 10.6 ↓ | 7: 10.6 ← | | |
| 3: 10.3 ↗ | 8: 10.1 ↓ | Total 100 | |
| 4: 10.5 ← | 9: 10.1 ← | | |
| 5: 10.5 ↗ | 10: 10.7x ↓ | | |

| | | | |
|-------------|------------|--------------|--|
| 11: 10.2 → | 16: 10.5 ↑ | Serie 99 | |
| 12: 10.7x ↘ | 17: 9.9 ↗ | | |
| 13: 10.7x ↑ | 18: 10.3 ← | Total 199 | |
| 14: 10.0 ↑ | 19: 10.4 ↑ | | |
| 15: 10.5 ↖ | 20: 10.0 → | | |

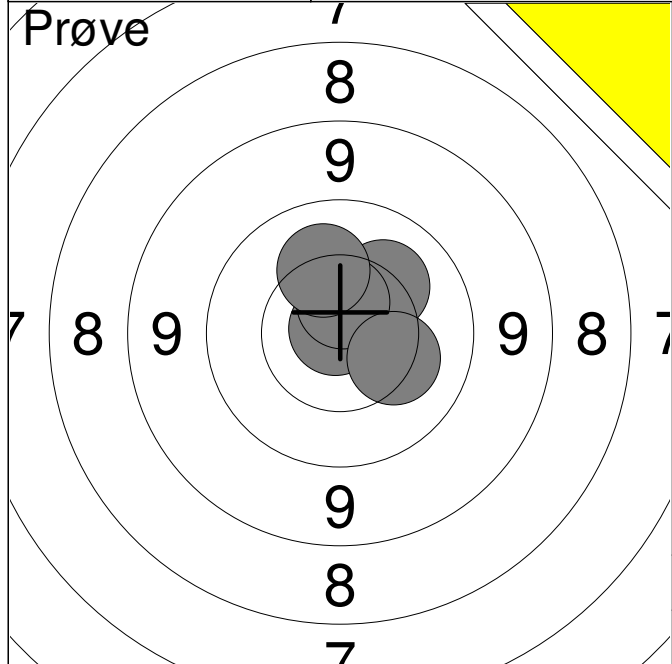

| | | |
|--------------|-------|-------------|
| 1: | 10.2 | ↗ |
| 2: | 10.9x | ↗ |
| 3: | 10.6x | ↑ |
| 4: | 10.2 | ↑ |
| 5: | 10.3 | ↘ |
| Serie | | 50.0 |
| Total | | 0.0 |

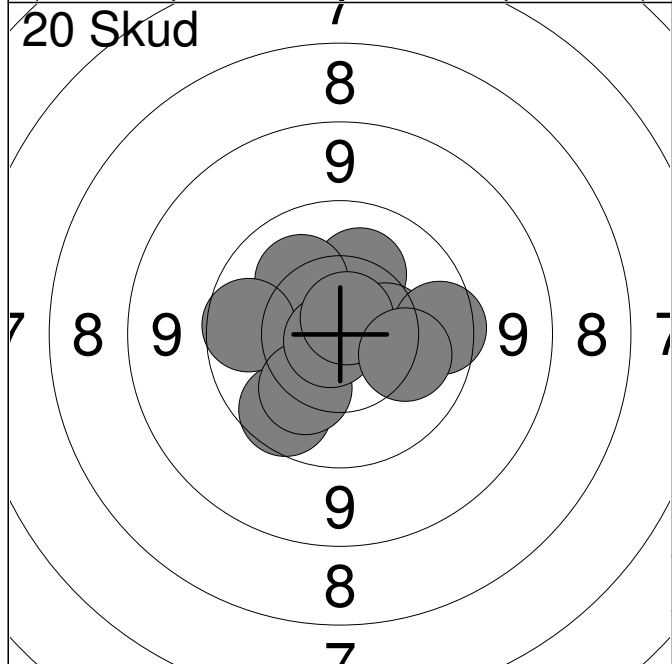

| | | |
|--------------|-------|-------------|
| 1: | 9.9 | ↙ |
| 2: | 10.2 | ↑ |
| 3: | 10.2 | ↗ |
| 4: | 9.9 | ← |
| 5: | 10.4 | → |
| 6: | 10.2 | ↙ |
| 7: | 9.8 | → |
| 8: | 10.8x | ↙ |
| 9: | 10.8x | ↑ |
| 10: | 10.2 | → |
| Serie | | 97.0 |
| Total | | 97.0 |

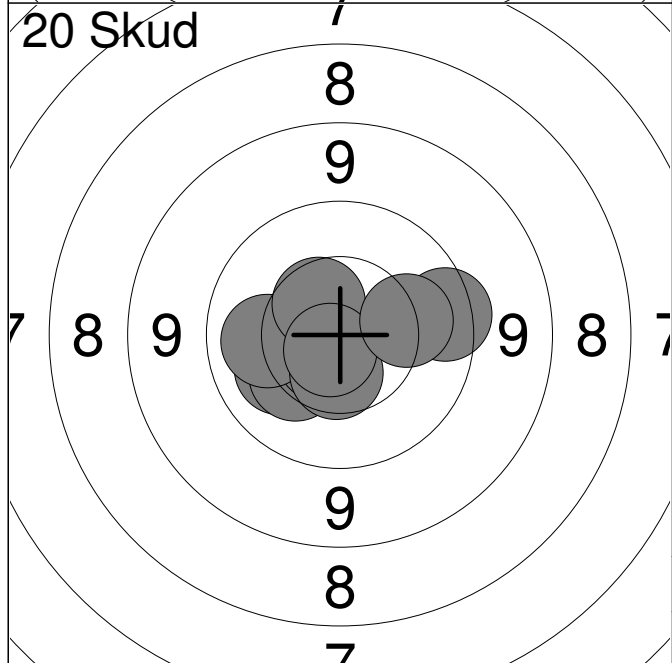

| | | |
|--------------|-------|--------------|
| 11: | 10.7x | ← |
| 12: | 10.2 | ↙ |
| 13: | 10.3 | ↙ |
| 14: | 10.6x | ↙ |
| 15: | 10.1 | ← |
| 16: | 10.5 | ↗ |
| 17: | 9.7 | → |
| 18: | 10.5 | ↓ |
| 19: | 10.7x | ↙ |
| 20: | 10.2 | → |
| Serie | | 99.0 |
| Total | | 196.0 |

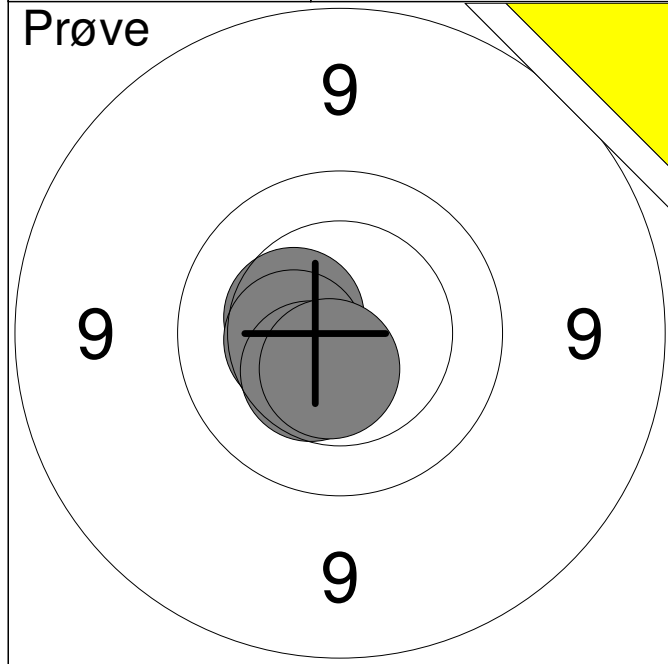

| | | | |
|--------------|----|-------|-------------|
| | 1: | 10.4 | ← |
| | 2: | 10.4 | ← |
| | 3: | 10.4 | ↘ |
| | 4: | 10.6x | ↓ |
| Serie | | | 40.0 |
| Total | | | 0.0 |

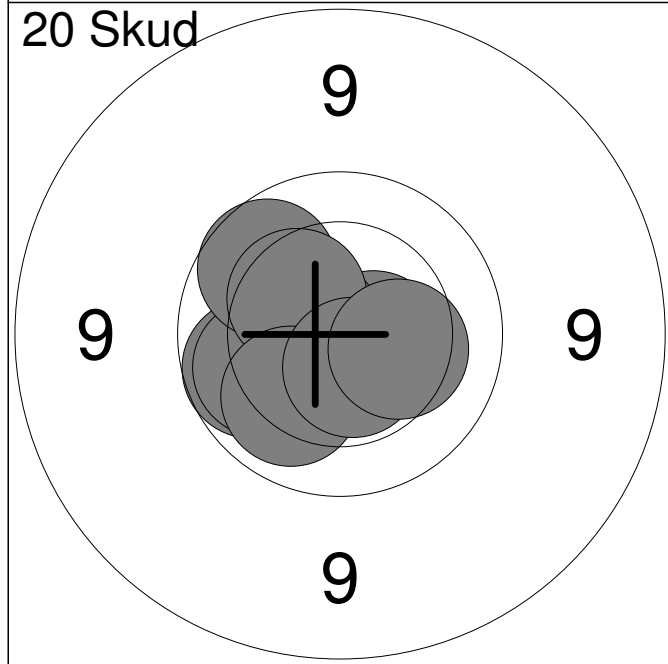

| | | | |
|--------------|-----|-------|-------------|
| | 1: | 9.9 | ← |
| | 2: | 10.6x | → |
| | 3: | 10.7x | ← |
| | 4: | 10.4 | ← |
| | 5: | 10.0 | ← |
| | 6: | 9.9 | ↗ |
| | 7: | 10.3 | ↗ |
| | 8: | 10.1 | ↓ |
| | 9: | 10.6x | ↓ |
| | 10: | 10.3 | → |
| Serie | | | 98.0 |
| Total | | | 98.0 |

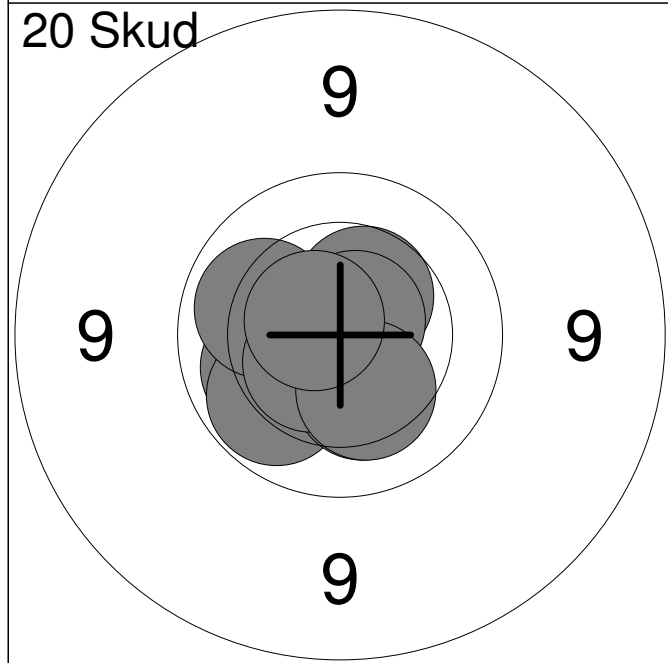

| | | | |
|--------------|-----|-------|--------------|
| | 11: | 10.5 | ← |
| | 12: | 10.5 | ↗ |
| | 13: | 10.1 | ← |
| | 14: | 10.0 | ↓ |
| | 15: | 10.1 | ← |
| | 16: | 10.3 | ↓ |
| | 17: | 10.7x | ↗ |
| | 18: | 10.5x | ↘ |
| | 19: | 10.3 | ↓ |
| | 20: | 10.6x | ↗ |
| Serie | | | 100.0 |
| Total | | | 198.0 |

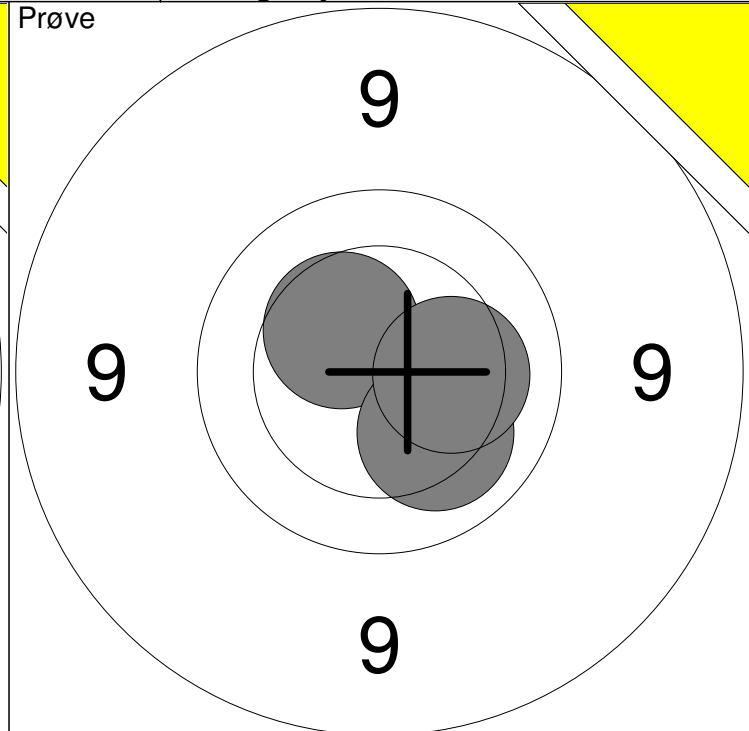
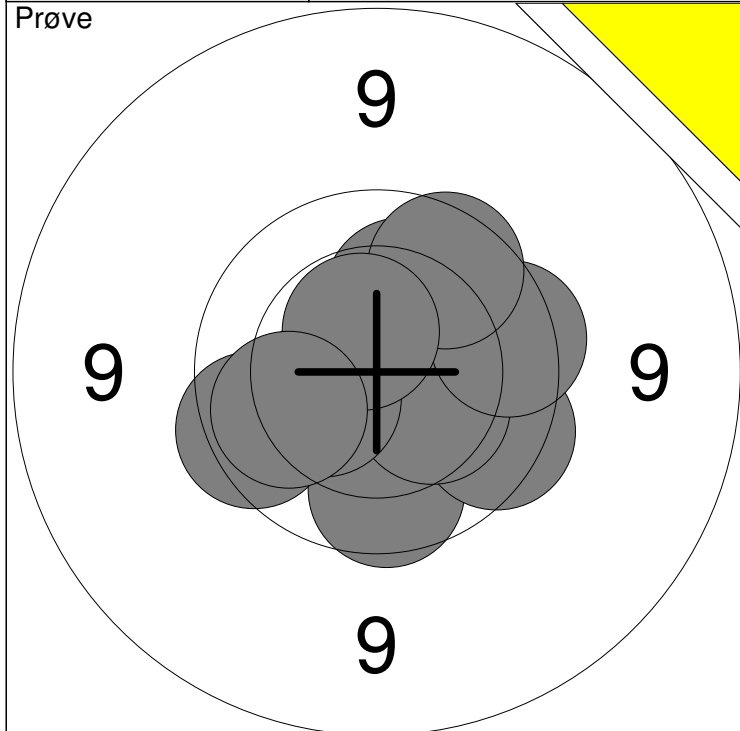

| | | | |
|-----------|------------|-------|----|
| 1: 9.9 ↓ | 6: 10.2 ↗ | Serie | 95 |
| 2: 9.8 ↙ | 7: 9.8 → | | |
| 3: 9.8 ↘ | 8: 9.8 ↗ | Total | 0 |
| 4: 10.3 ↘ | 9: 10.5x ↗ | | |
| 5: 10.4 ↙ | 10: 10.0 ↙ | | |

| | | |
|------------|-------|----|
| 11: 10.4 ↗ | Serie | 30 |
| 12: 10.2 ↘ | | |
| 13: 10.3 → | Total | 0 |
| | | |

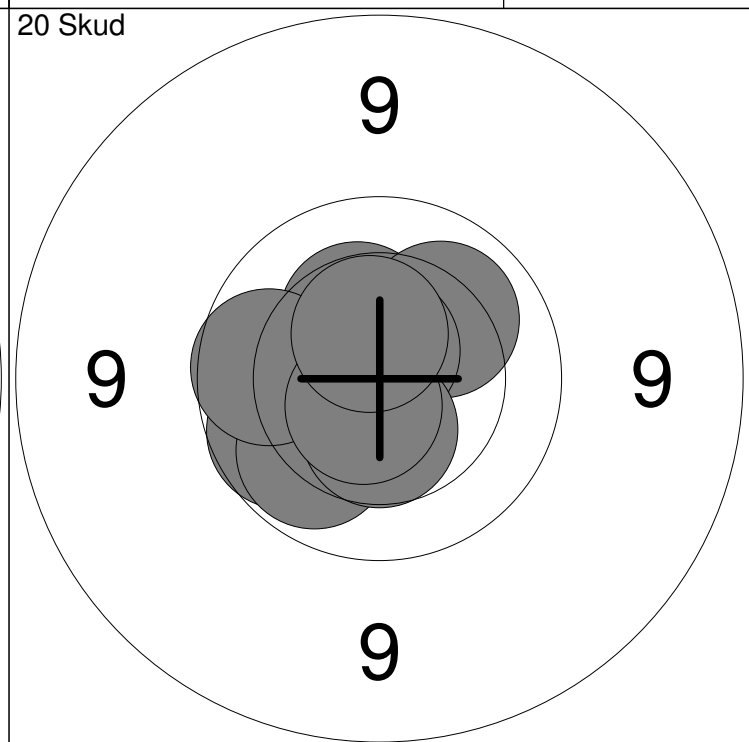
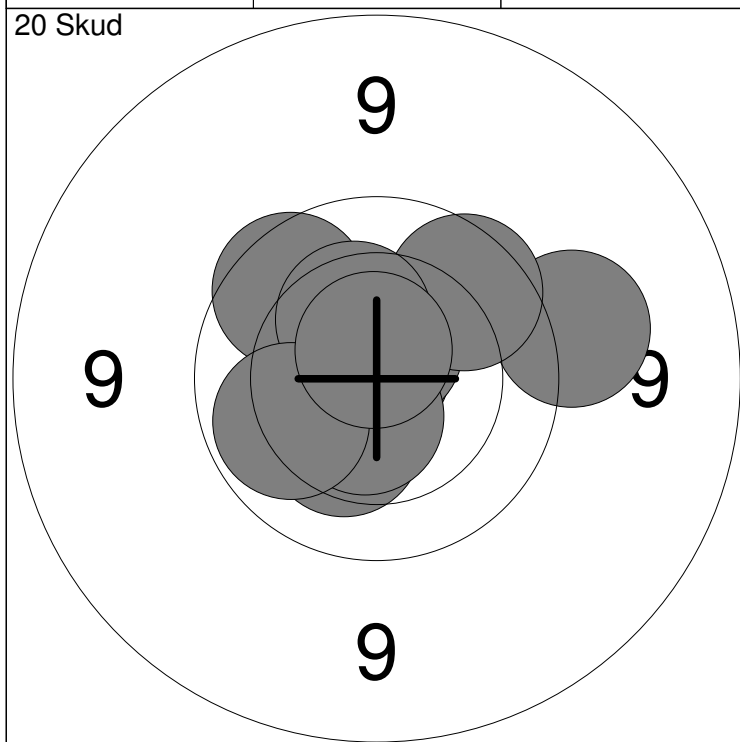

| | | | |
|------------|-------------|-------|----|
| 1: 10.3 ↙ | 6: 9.8 ↗ | Serie | 97 |
| 2: 9.4 → | 7: 10.6x ↘ | | |
| 3: 10.8x ↗ | 8: 10.3 ↗ | Total | 97 |
| 4: 9.8 ↗ | 9: 10.0 ↙ | | |
| 5: 10.6x ↗ | 10: 10.7x ↗ | | |

| | | | |
|-------------|-------------|-------|-----|
| 11: 10.4 ↗ | 16: 10.7x ↗ | Serie | 98 |
| 12: 10.1 ↗ | 17: 9.9 ↙ | | |
| 13: 9.9 ↙ | 18: 10.5 ↘ | Total | 195 |
| 14: 10.6x ↘ | 19: 10.6x ↘ | | |
| 15: 10.0 ↙ | 20: 10.5x ↗ | | |

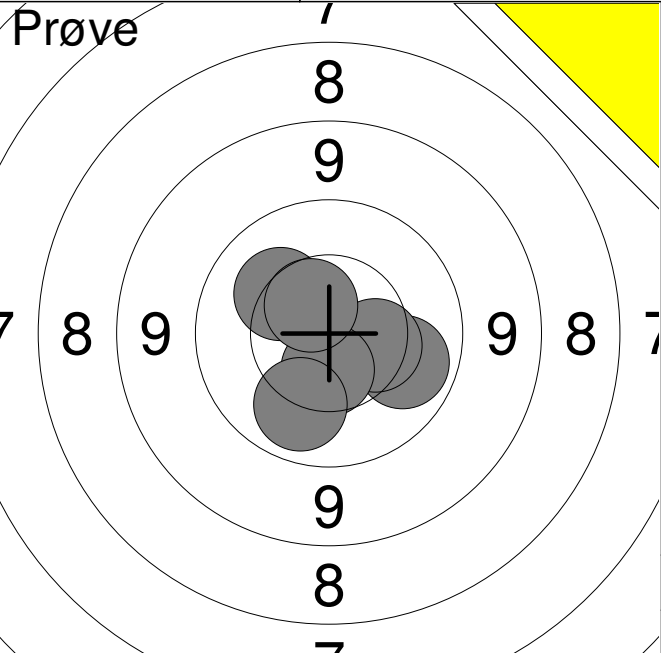
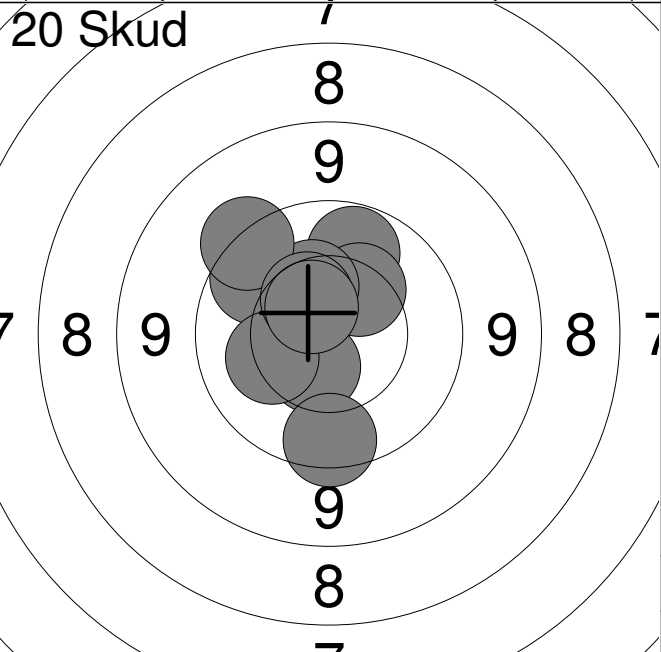
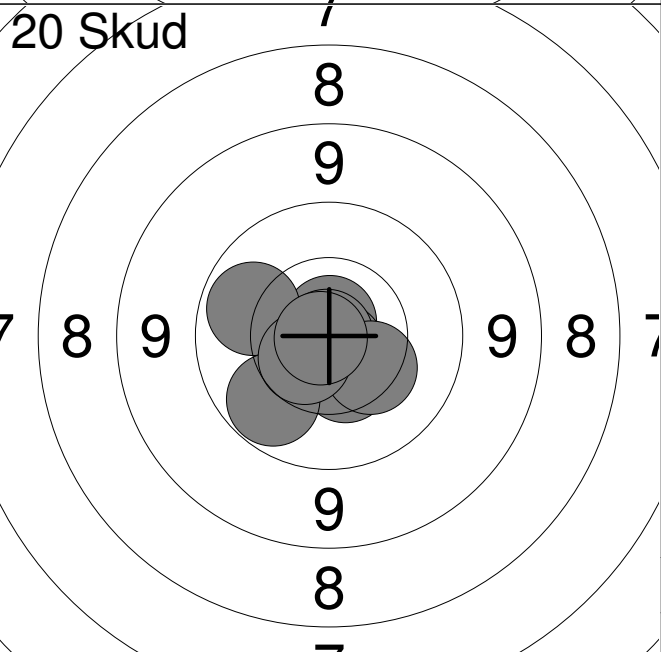
| | | | | | | | | | | | | | | | | | | | | | | | | | | | | | | | |
|--|---|---------------------|-------|---|-----|------|---|-----|-------|---|-----|------|---|-----|-------|---|-----|-------|---|-----|------|---|-----|------|---|-----|------|---|-----|-------|---|
| | 15 meter riffelstævne oktober 2 | Aalborg Skyttekreds | | | | | | | | | | | | | | | | | | | | | | | | | | | | | |
| Prøve  | <table style="width:100%; border-collapse: collapse;"> <tr><td style="width:10%;">1:</td><td style="width:70%;">10.0</td><td style="width:20%; text-align: right;">↘</td></tr> <tr><td>2:</td><td>10.4</td><td style="text-align: right;">↘</td></tr> <tr><td>3:</td><td>10.5</td><td style="text-align: right;">↓</td></tr> <tr><td>4:</td><td>10.1</td><td style="text-align: right;">↙</td></tr> <tr><td>5:</td><td>10.2</td><td style="text-align: right;">↗</td></tr> <tr><td>6:</td><td>10.6</td><td style="text-align: right;">↗</td></tr> </table> | 1: | 10.0 | ↘ | 2: | 10.4 | ↘ | 3: | 10.5 | ↓ | 4: | 10.1 | ↙ | 5: | 10.2 | ↗ | 6: | 10.6 | ↗ | | | | | | | | | | | | |
| 1: | 10.0 | ↘ | | | | | | | | | | | | | | | | | | | | | | | | | | | | | |
| 2: | 10.4 | ↘ | | | | | | | | | | | | | | | | | | | | | | | | | | | | | |
| 3: | 10.5 | ↓ | | | | | | | | | | | | | | | | | | | | | | | | | | | | | |
| 4: | 10.1 | ↙ | | | | | | | | | | | | | | | | | | | | | | | | | | | | | |
| 5: | 10.2 | ↗ | | | | | | | | | | | | | | | | | | | | | | | | | | | | | |
| 6: | 10.6 | ↗ | | | | | | | | | | | | | | | | | | | | | | | | | | | | | |
| | Serie | 60.0 | | | | | | | | | | | | | | | | | | | | | | | | | | | | | |
| | Total | 0.0 | | | | | | | | | | | | | | | | | | | | | | | | | | | | | |
| 20 Skud  | <table style="width:100%; border-collapse: collapse;"> <tr><td style="width:10%;">1:</td><td style="width:70%;">10.0</td><td style="width:20%; text-align: right;">↑</td></tr> <tr><td>2:</td><td>10.3</td><td style="text-align: right;">↗</td></tr> <tr><td>3:</td><td>9.9</td><td style="text-align: right;">↗</td></tr> <tr><td>4:</td><td>10.4</td><td style="text-align: right;">↗</td></tr> <tr><td>5:</td><td>9.5</td><td style="text-align: right;">↗</td></tr> <tr><td>6:</td><td>10.5</td><td style="text-align: right;">↓</td></tr> <tr><td>7:</td><td>10.2</td><td style="text-align: right;">←</td></tr> <tr><td>8:</td><td>10.5</td><td style="text-align: right;">↗</td></tr> <tr><td>9:</td><td>10.6</td><td style="text-align: right;">↗</td></tr> <tr><td>10:</td><td>9.7</td><td style="text-align: right;">↓</td></tr> </table> | 1: | 10.0 | ↑ | 2: | 10.3 | ↗ | 3: | 9.9 | ↗ | 4: | 10.4 | ↗ | 5: | 9.5 | ↗ | 6: | 10.5 | ↓ | 7: | 10.2 | ← | 8: | 10.5 | ↗ | 9: | 10.6 | ↗ | 10: | 9.7 | ↓ |
| 1: | 10.0 | ↑ | | | | | | | | | | | | | | | | | | | | | | | | | | | | | |
| 2: | 10.3 | ↗ | | | | | | | | | | | | | | | | | | | | | | | | | | | | | |
| 3: | 9.9 | ↗ | | | | | | | | | | | | | | | | | | | | | | | | | | | | | |
| 4: | 10.4 | ↗ | | | | | | | | | | | | | | | | | | | | | | | | | | | | | |
| 5: | 9.5 | ↗ | | | | | | | | | | | | | | | | | | | | | | | | | | | | | |
| 6: | 10.5 | ↓ | | | | | | | | | | | | | | | | | | | | | | | | | | | | | |
| 7: | 10.2 | ← | | | | | | | | | | | | | | | | | | | | | | | | | | | | | |
| 8: | 10.5 | ↗ | | | | | | | | | | | | | | | | | | | | | | | | | | | | | |
| 9: | 10.6 | ↗ | | | | | | | | | | | | | | | | | | | | | | | | | | | | | |
| 10: | 9.7 | ↓ | | | | | | | | | | | | | | | | | | | | | | | | | | | | | |
| | Serie | 97.0 | | | | | | | | | | | | | | | | | | | | | | | | | | | | | |
| | Total | 97.0 | | | | | | | | | | | | | | | | | | | | | | | | | | | | | |
| 20 Skud  | <table style="width:100%; border-collapse: collapse;"> <tr><td style="width:10%;">11:</td><td style="width:70%;">10.8x</td><td style="width:20%; text-align: right;">↑</td></tr> <tr><td>12:</td><td>10.0</td><td style="text-align: right;">↖</td></tr> <tr><td>13:</td><td>10.8x</td><td style="text-align: right;">↓</td></tr> <tr><td>14:</td><td>10.4</td><td style="text-align: right;">↓</td></tr> <tr><td>15:</td><td>10.8x</td><td style="text-align: right;">↖</td></tr> <tr><td>16:</td><td>10.9x</td><td style="text-align: right;">←</td></tr> <tr><td>17:</td><td>10.3</td><td style="text-align: right;">↓</td></tr> <tr><td>18:</td><td>10.0</td><td style="text-align: right;">↙</td></tr> <tr><td>19:</td><td>10.6</td><td style="text-align: right;">↙</td></tr> <tr><td>20:</td><td>10.8x</td><td style="text-align: right;">←</td></tr> </table> | 11: | 10.8x | ↑ | 12: | 10.0 | ↖ | 13: | 10.8x | ↓ | 14: | 10.4 | ↓ | 15: | 10.8x | ↖ | 16: | 10.9x | ← | 17: | 10.3 | ↓ | 18: | 10.0 | ↙ | 19: | 10.6 | ↙ | 20: | 10.8x | ← |
| 11: | 10.8x | ↑ | | | | | | | | | | | | | | | | | | | | | | | | | | | | | |
| 12: | 10.0 | ↖ | | | | | | | | | | | | | | | | | | | | | | | | | | | | | |
| 13: | 10.8x | ↓ | | | | | | | | | | | | | | | | | | | | | | | | | | | | | |
| 14: | 10.4 | ↓ | | | | | | | | | | | | | | | | | | | | | | | | | | | | | |
| 15: | 10.8x | ↖ | | | | | | | | | | | | | | | | | | | | | | | | | | | | | |
| 16: | 10.9x | ← | | | | | | | | | | | | | | | | | | | | | | | | | | | | | |
| 17: | 10.3 | ↓ | | | | | | | | | | | | | | | | | | | | | | | | | | | | | |
| 18: | 10.0 | ↙ | | | | | | | | | | | | | | | | | | | | | | | | | | | | | |
| 19: | 10.6 | ↙ | | | | | | | | | | | | | | | | | | | | | | | | | | | | | |
| 20: | 10.8x | ← | | | | | | | | | | | | | | | | | | | | | | | | | | | | | |
| | Serie | 100.0 | | | | | | | | | | | | | | | | | | | | | | | | | | | | | |
| | Total | 197.0 | | | | | | | | | | | | | | | | | | | | | | | | | | | | | |

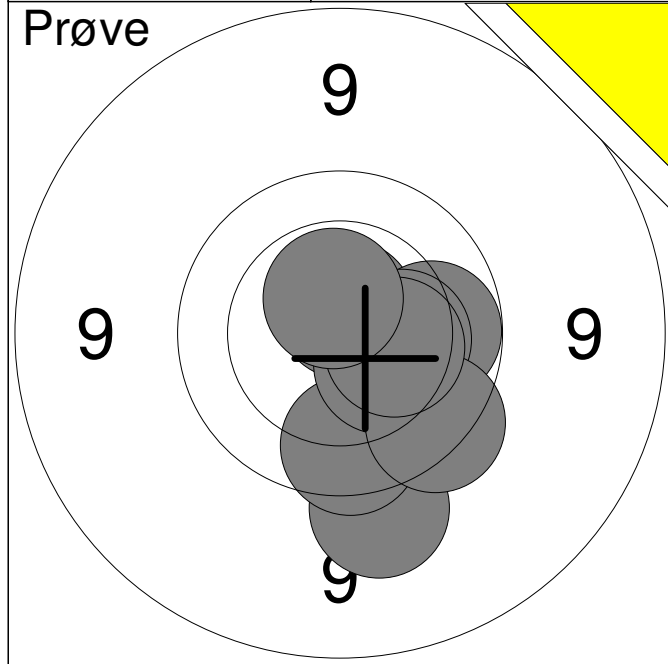

| | | |
|--------------|-------|-------------|
| 1: | 9.4 | ↓ |
| 2: | 9.8 | ↓ |
| 3: | 10.7x | ↑ |
| 4: | 10.0 | → |
| 5: | 10.3 | → |
| 6: | 10.4 | ↓ |
| 7: | 9.7 | ↓ |
| 8: | 10.3 | → |
| 9: | 10.6x | ↑ |
| Serie | | 87.0 |
| Total | | 0.0 |

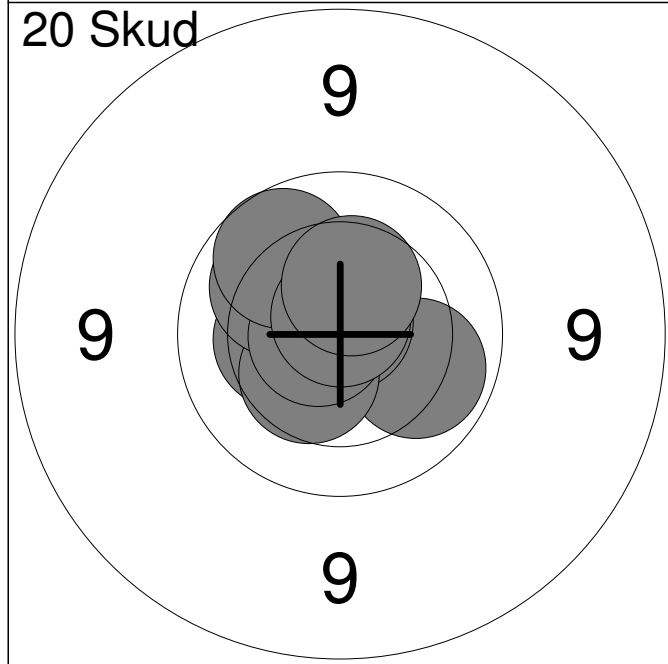

| | | |
|--------------|-------|-------------|
| 1: | 10.1 | → |
| 2: | 10.8x | ↑ |
| 3: | 10.6x | ↗ |
| 4: | 10.3 | ← |
| 5: | 10.4 | ↙ |
| 6: | 10.1 | ↗ |
| 7: | 10.7x | ← |
| 8: | 9.9 | ↗ |
| 9: | 10.8x | ↑ |
| 10: | 10.4 | ↑ |
| Serie | | 99.0 |
| Total | | 99.0 |

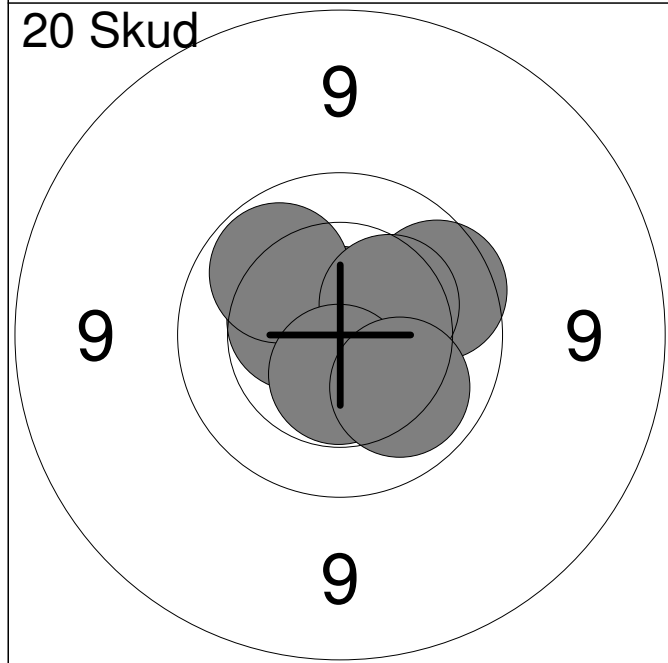

| | | |
|--------------|-------|--------------|
| 11: | 10.5 | ↗ |
| 12: | 10.5 | ↓ |
| 13: | 10.8x | ↓ |
| 14: | 9.9 | → |
| 15: | 10.7x | ↑ |
| 16: | 10.5 | ↖ |
| 17: | 10.0 | ↗ |
| 18: | 10.3 | ↗ |
| 19: | 10.5x | ↓ |
| 20: | 10.1 | ↙ |
| Serie | | 99.0 |
| Total | | 198.0 |

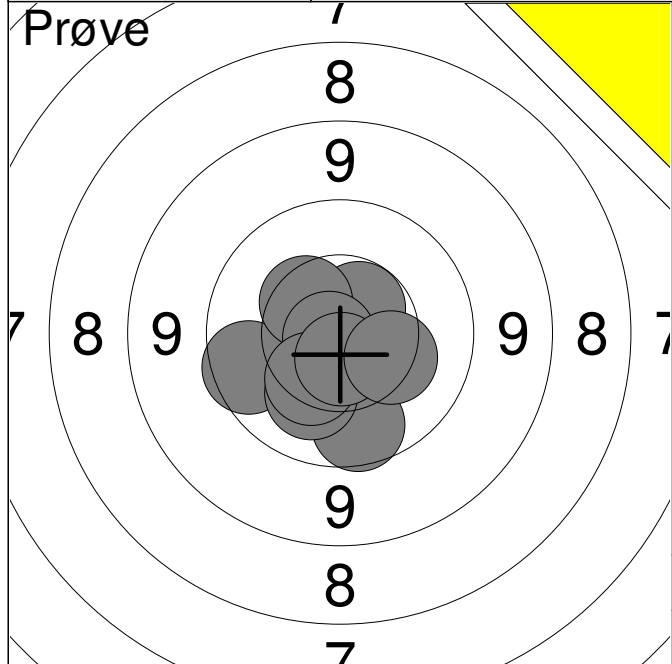

| | | |
|----|-------|---|
| 1: | 10.6x | ↗ |
| 2: | 9.9 | ↓ |
| 3: | 9.8 | ↖ |
| 4: | 10.4 | ↗ |
| 5: | 10.8x | ↖ |
| 6: | 10.2 | ↓ |
| 7: | 10.3 | ↖ |
| 8: | 10.7x | ↓ |
| 9: | 10.3 | ↘ |

| | |
|--------------|-------------|
| Serie | 88.0 |
| Total | 0.0 |

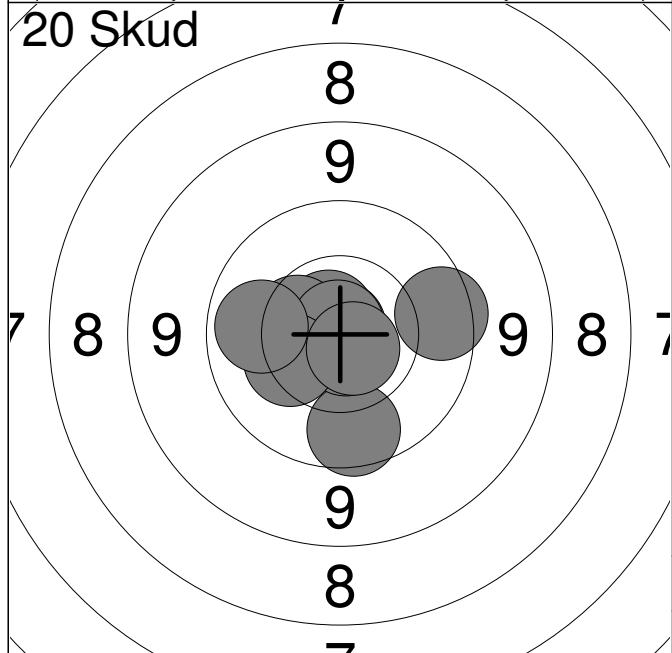

| | | |
|-----|-------|---|
| 1: | 10.9x | ↑ |
| 2: | 9.8 | ↓ |
| 3: | 10.7x | ↗ |
| 4: | 10.8x | ↓ |
| 5: | 10.4 | ↖ |
| 6: | 10.9x | ↑ |
| 7: | 9.7 | → |
| 8: | 10.3 | ↖ |
| 9: | 10.0 | ↖ |
| 10: | 10.7x | ↓ |

| | |
|--------------|-------------|
| Serie | 98.0 |
| Total | 98.0 |

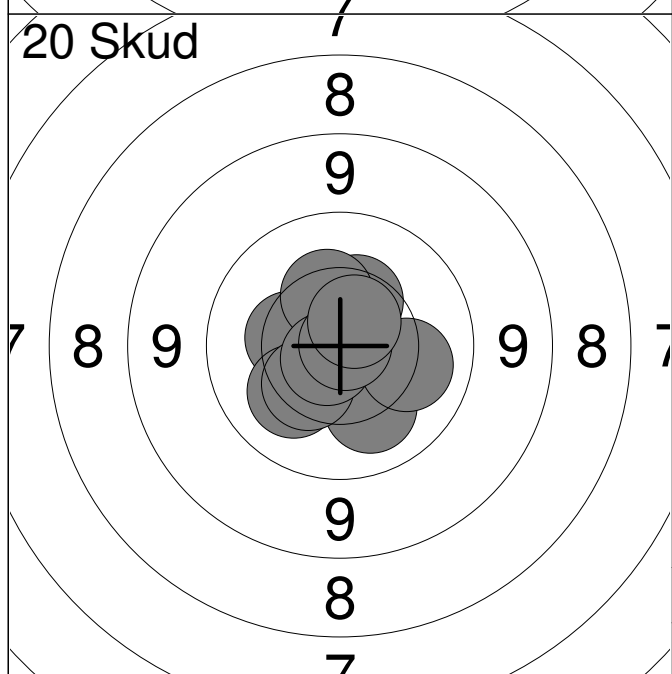

| | | |
|-----|-------|---|
| 11: | 10.4 | ↖ |
| 12: | 10.4 | ↑ |
| 13: | 10.2 | ↖ |
| 14: | 10.2 | ↓ |
| 15: | 10.4 | ↑ |
| 16: | 10.2 | → |
| 17: | 10.4 | ↖ |
| 18: | 10.7x | ↖ |
| 19: | 10.9x | → |
| 20: | 10.6x | ↗ |

| | |
|--------------|--------------|
| Serie | 100.0 |
| Total | 198.0 |

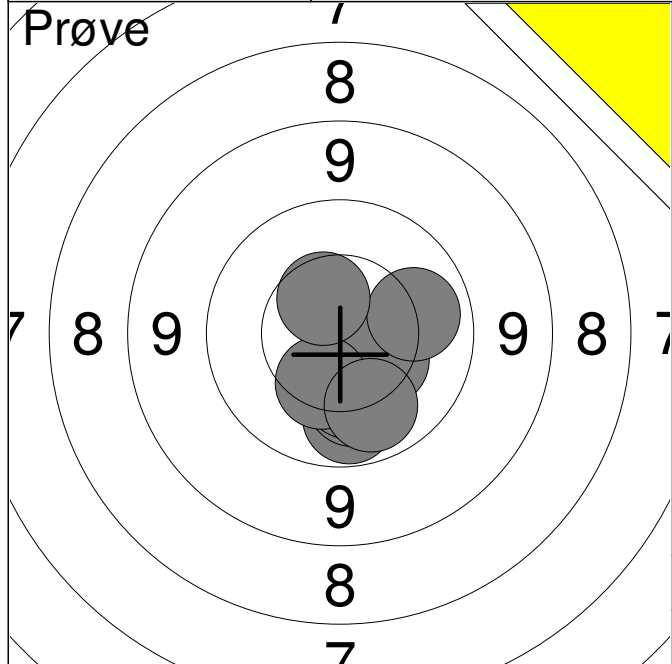

| | | |
|--------------|------|-------------|
| 1: | 10.0 | ↓ |
| 2: | 10.2 | ↓ |
| 3: | 10.3 | ↓ |
| 4: | 10.4 | ↓ |
| 5: | 10.3 | ↓ |
| 6: | 10.0 | ↓ |
| 7: | 10.1 | → |
| 8: | 10.5 | ↑ |
| Serie | | 80.0 |
| Total | | 0.0 |

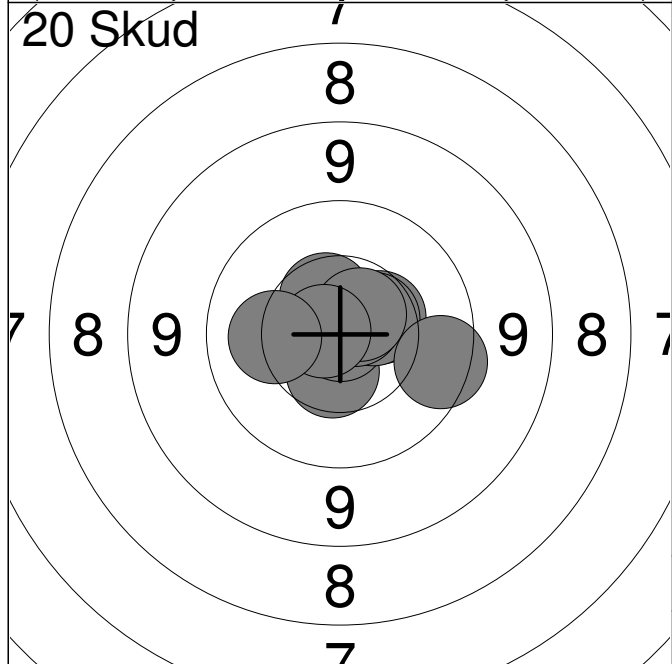

| | | |
|--------------|-------|-------------|
| 1: | 10.5 | ↑ |
| 2: | 10.5 | ↓ |
| 3: | 10.5 | → |
| 4: | 10.9x | → |
| 5: | 10.5 | → |
| 6: | 10.7x | ↗ |
| 7: | 10.6x | ↗ |
| 8: | 10.8x | ← |
| 9: | 10.2 | ← |
| 10: | 9.7 | → |
| Serie | | 99.0 |
| Total | | 99.0 |

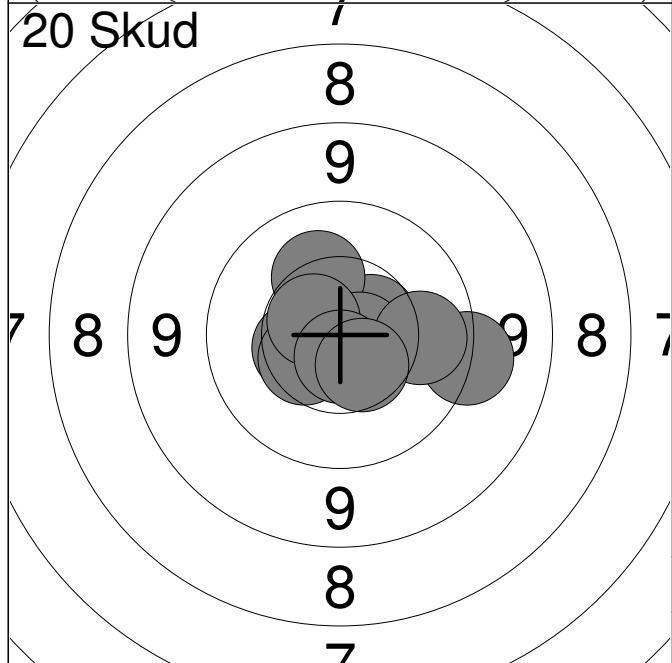

| | | |
|--------------|-------|--------------|
| 11: | 10.6 | ↗ |
| 12: | 10.2 | ↑ |
| 13: | 9.4 | → |
| 14: | 10.5 | ← |
| 15: | 10.7x | → |
| 16: | 10.5 | ↖ |
| 17: | 10.0 | → |
| 18: | 10.6x | ↗ |
| 19: | 10.7x | ↓ |
| 20: | 10.5 | ↓ |
| Serie | | 99.0 |
| Total | | 198.0 |

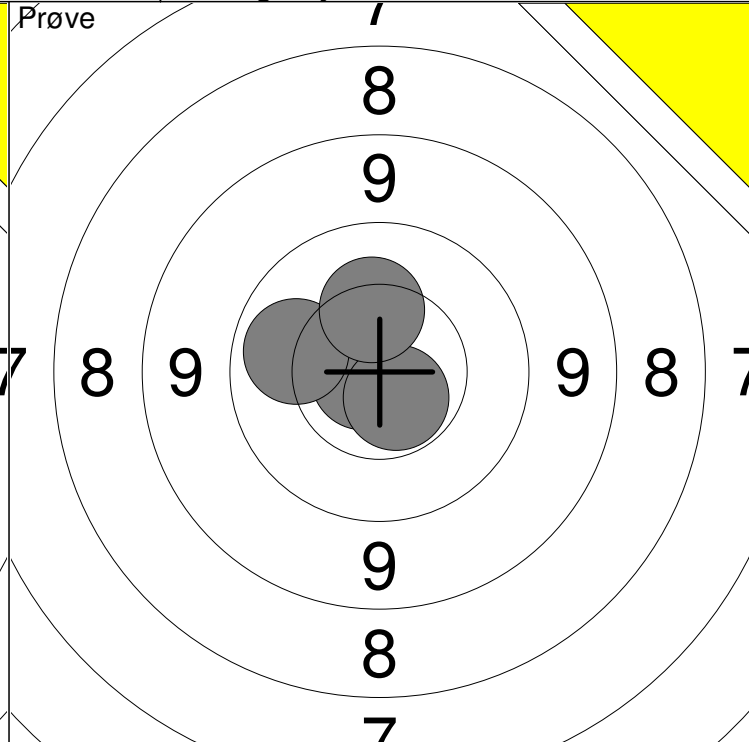
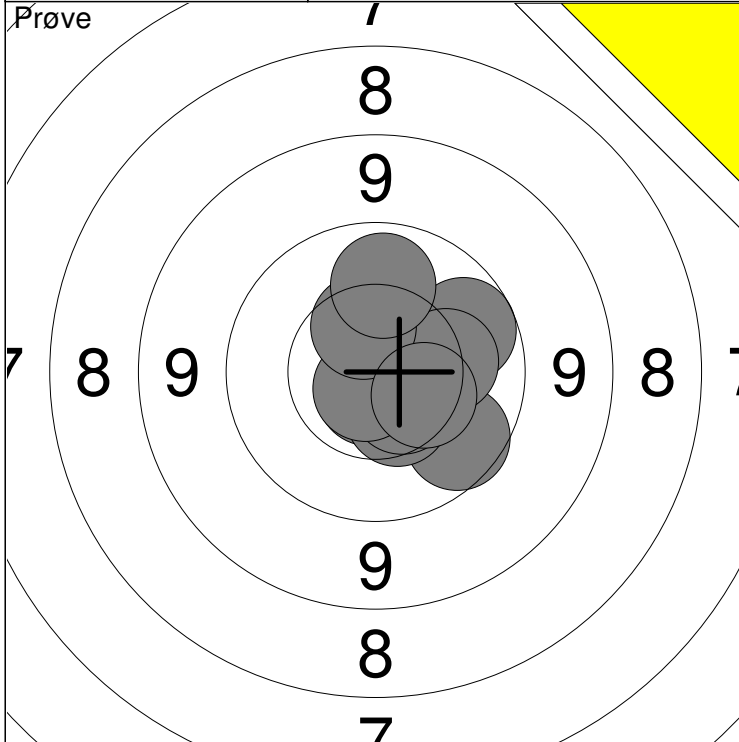

| | | | |
|------------|------------|-------|----|
| 1: 9.9 → | 6: 10.5 ↓ | Serie | 98 |
| 2: 9.9 ↓ | 7: 10.7x ↓ | | |
| 3: 10.2 → | 8: 10.5 ↑ | Total | 0 |
| 4: 10.7x ↓ | 9: 10.1 ↑ | | |
| 5: 10.5 ↓ | 10: 10.4 ↘ | | |

| | | |
|-------------|-------|----|
| 11: 10.8x ← | Serie | 40 |
| 12: 10.1 ← | | |
| 13: 10.6x ↓ | Total | 0 |
| 14: 10.3 ↑ | | |

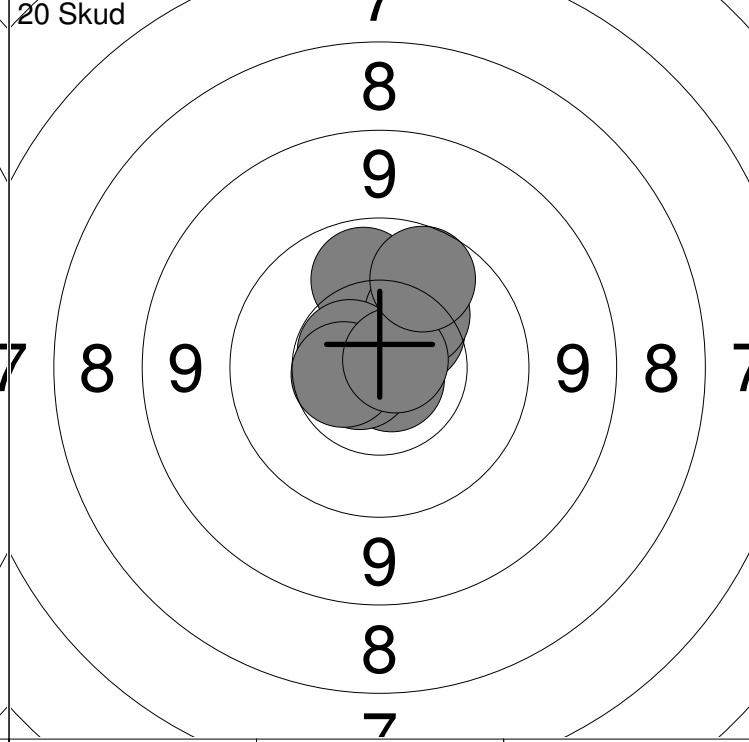
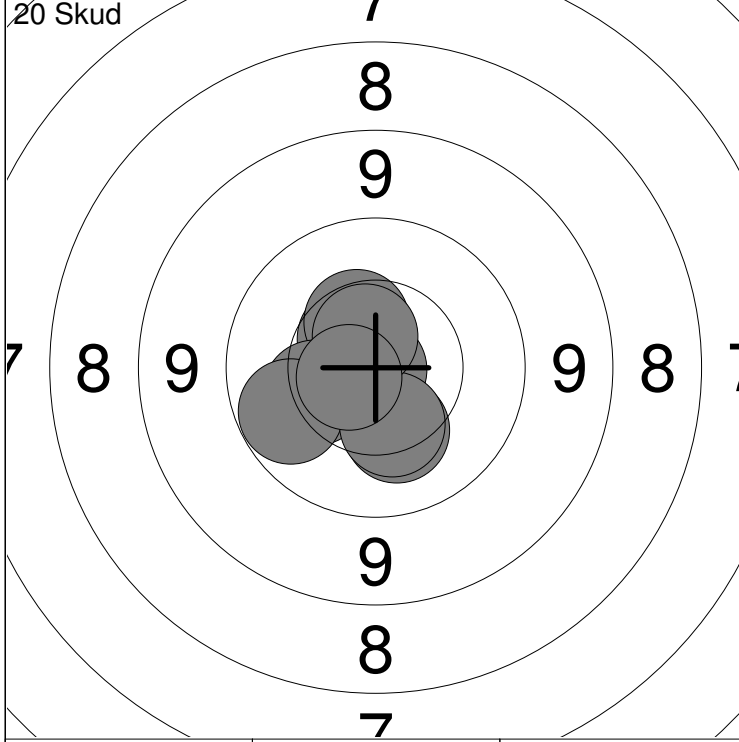

| | | | |
|------------|-------------|-------|-----|
| 1: 10.6 ↑ | 6: 10.3 ← | Serie | 100 |
| 2: 10.9x ↓ | 7: 10.0 ← | | |
| 3: 10.6 ↑ | 8: 10.3 ↓ | Total | 100 |
| 4: 10.4 ↑ | 9: 10.6x ↑ | | |
| 5: 10.3 ↓ | 10: 10.7x ← | | |

| | | | |
|-------------|-------------|-------|-----|
| 11: 10.9x ↗ | 16: 10.7x ← | Serie | 99 |
| 12: 10.0 ↑ | 17: 10.6x ← | | |
| 13: 10.8x ↓ | 18: 10.6 ← | Total | 199 |
| 14: 10.4 ↗ | 19: 10.8x ↗ | | |
| 15: 10.3 ↗ | 20: 9.9 ↑ | | |

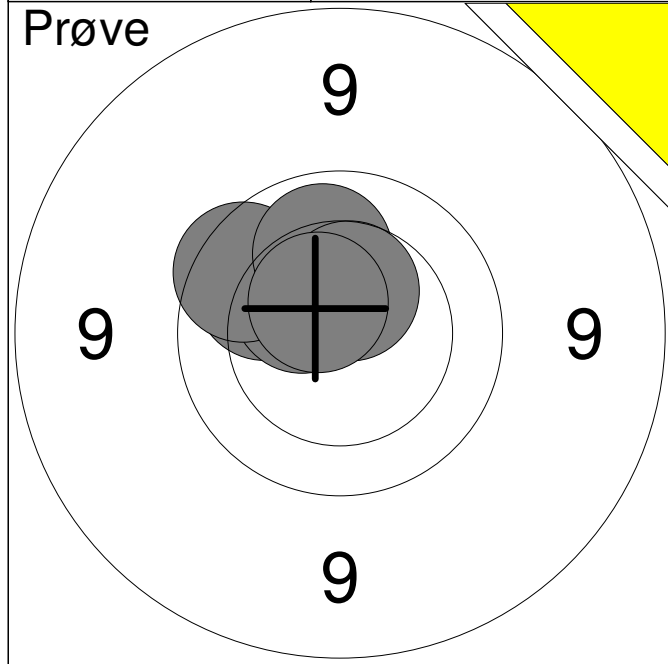

| | | |
|----|-------|---|
| 1: | 10.0 | ↗ |
| 2: | 10.4 | ↗ |
| 3: | 9.8 | ↗ |
| 4: | 10.1 | ↑ |
| 5: | 10.5 | ↑ |
| 6: | 10.5x | ↗ |

| | |
|-------|------|
| Serie | 59.0 |
| Total | 0.0 |

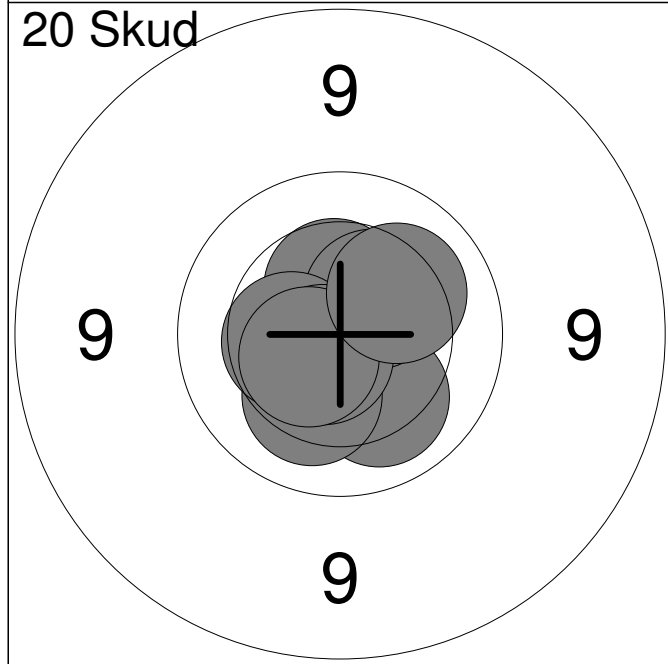

| | | |
|-----|-------|---|
| 1: | 10.6x | ↗ |
| 2: | 10.5 | ↑ |
| 3: | 10.5x | ↘ |
| 4: | 10.1 | ↘ |
| 5: | 10.4 | ↗ |
| 6: | 10.2 | ↘ |
| 7: | 10.4 | ← |
| 8: | 10.7x | ↘ |
| 9: | 10.5x | ↘ |
| 10: | 10.2 | ↗ |

| | |
|-------|-------|
| Serie | 100.0 |
| Total | 100.0 |

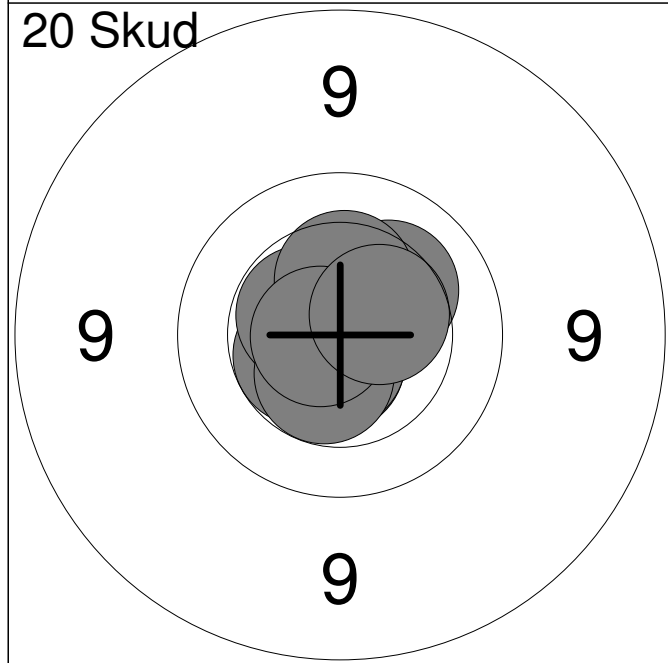

| | | |
|-----|-------|---|
| 11: | 10.6x | ↓ |
| 12: | 10.5x | ↙ |
| 13: | 10.5x | ↑ |
| 14: | 10.5x | ↖ |
| 15: | 10.7x | ↓ |
| 16: | 10.5x | ↘ |
| 17: | 10.2 | ↗ |
| 18: | 10.4 | ↑ |
| 19: | 10.7x | ← |
| 20: | 10.5 | ↗ |

| | |
|-------|-------|
| Serie | 100.0 |
| Total | 200.0 |

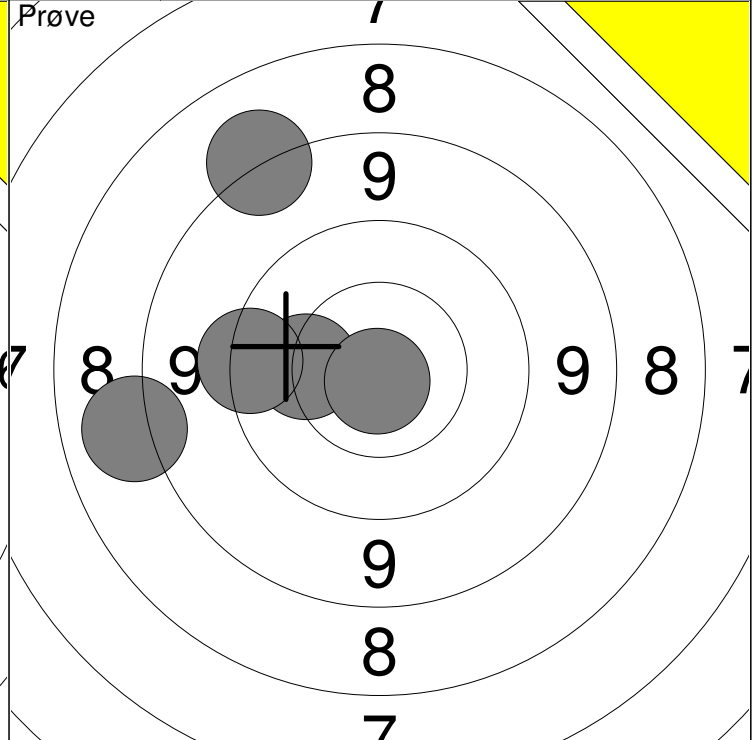
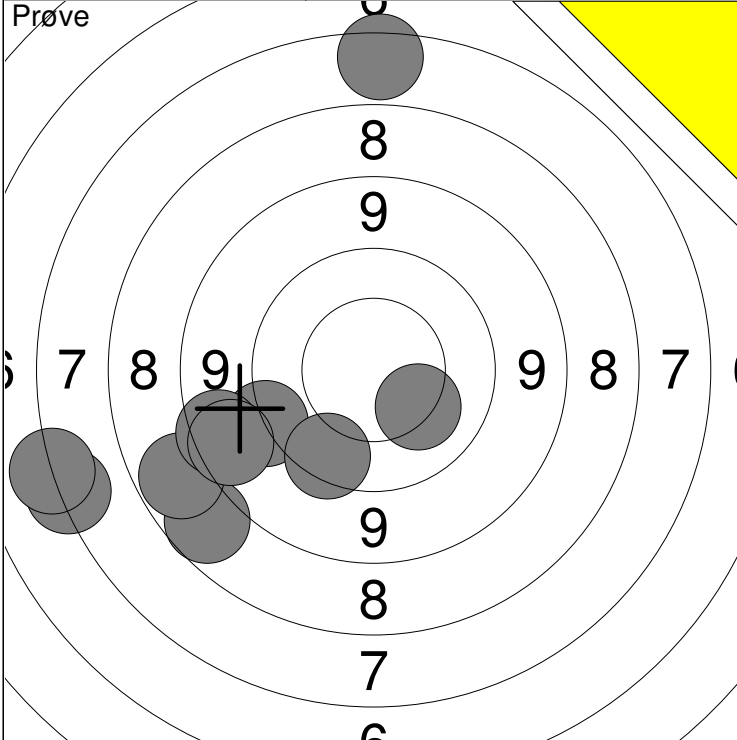

| | | | |
|-----------|-----------|-------|----|
| 1: 6.5 ← | 6: 8.0 ← | Serie | 77 |
| 2: 10.2 ↘ | 7: 8.7 ← | | |
| 3: 7.9 ↙ | 8: 9.7 ↘ | Total | 0 |
| 4: 9.4 ← | 9: 8.8 ← | | |
| 5: 6.7 ↑ | 10: 6.4 ← | | |

| | | |
|-------------|-------|----|
| 11: 10.2 ← | Serie | 45 |
| 12: 9.6 ← | | |
| 13: 8.2 ← | Total | 0 |
| 14: 8.3 ↗ | | |
| 15: 10.8x ↘ | | |

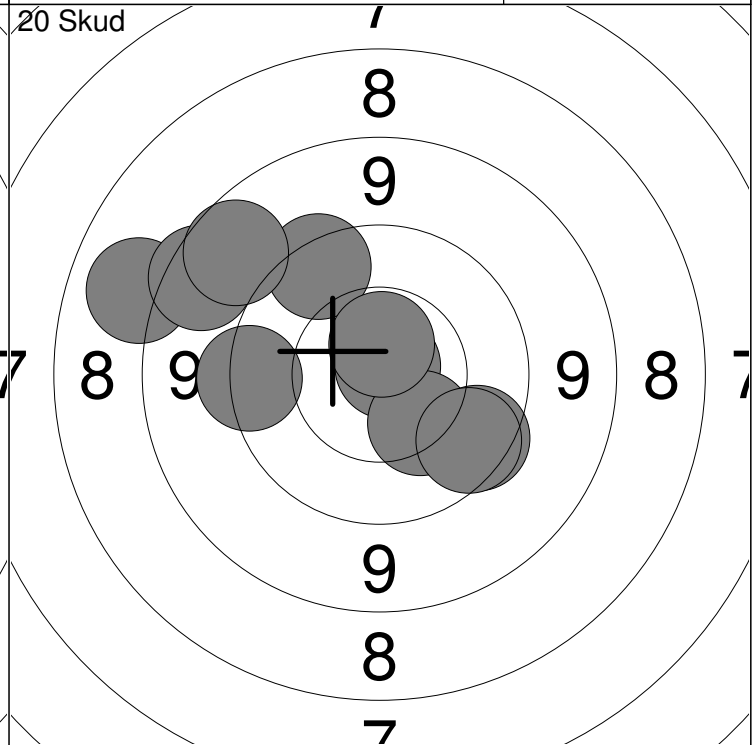
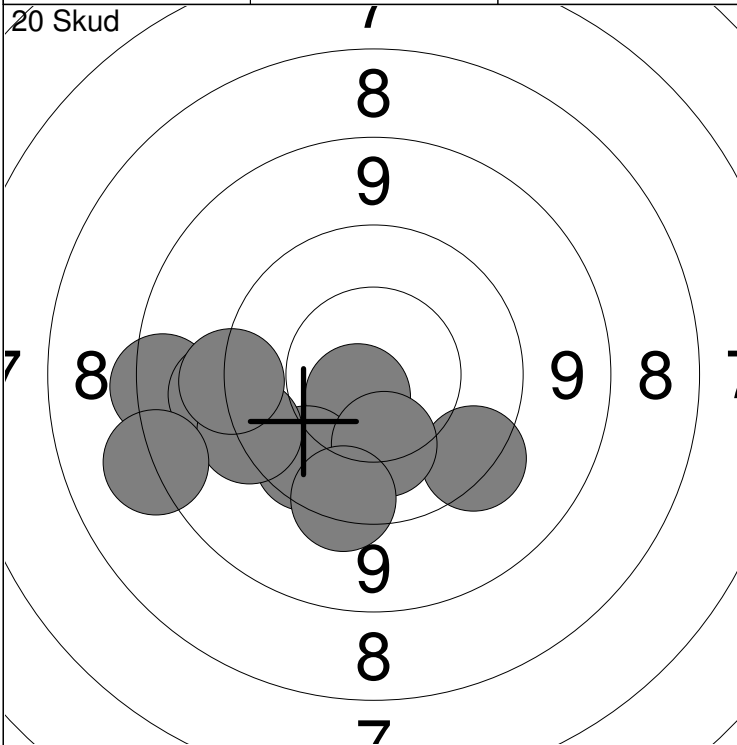

| | | | |
|------------|-----------|-------|----|
| 1: 9.6 ↘ | 6: 10.2 ↘ | Serie | 90 |
| 2: 10.7x ↘ | 7: 9.5 ← | | |
| 3: 8.6 ← | 8: 9.4 ← | Total | 90 |
| 4: 9.3 ← | 9: 9.6 ↘ | | |
| 5: 9.8 ↙ | 10: 8.4 ← | | |

| | | |
|-------------|-------------|-----|
| 11: 10.8x ↗ | Serie | 90 |
| 12: 10.3 ↘ | | |
| 13: 9.7 ↘ | Total | 180 |
| 14: 9.8 ↘ | | |
| 15: 9.6 ↗ | 16: 9.6 ← | |
| | 17: 8.2 ← | |
| | 18: 10.6x ↑ | |
| | 19: 8.7 ↙ | |
| | 20: 8.9 ↙ | |

| | | | |
|-------------------|-------------------|-----------------------------|--|
| Hold 28 | Skive 4 | Emil Myrup Langgaard | |
|-------------------|-------------------|-----------------------------|--|

| | | | |
|-----|--------------------------|-----|--|
| 15m | Løgstør Sportsskytteklub | MJ1 | |
|-----|--------------------------|-----|--|

| | | | |
|--|---------------------------------|---------------------|--|
| | 15 meter riffelstævne oktober 2 | Aalborg Skyttekreds | |
|--|---------------------------------|---------------------|--|

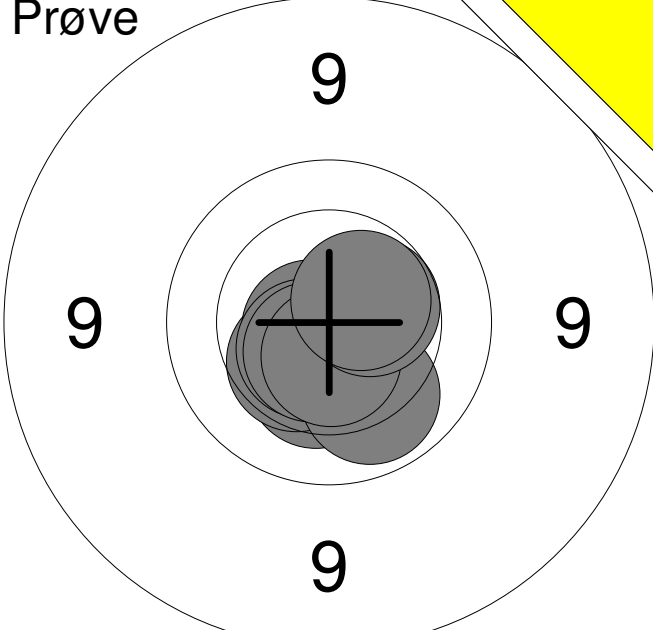
| | | | |
|--|--------------|------------|--------------|
| Prøve  | 1: | 10.3 | ↓ |
| | 2: | 10.8x | ↓ |
| | 3: | 10.4 | ↙ |
| | 4: | 10.7x | ← |
| | 5: | 10.6x | ↙ |
| | 6: | 10.1 | ↓ |
| | 7: | 10.6x | ↙ |
| | 8: | 10.6x | ↓ |
| | 9: | 10.5 | → |
| | 10: | 10.5x | ↗ |
| | Serie | | 100.0 |
| Total | | 0.0 | |

| | | | |
|---|--------------|-------------|-------------|
| 20 Skud  | 1: | 10.6x | ↓ |
| | 2: | 10.8x | ↙ |
| | 3: | 10.7x | ↗ |
| | 4: | 10.4 | ↑ |
| | 5: | 9.7 | ← |
| | 6: | 10.6x | ↑ |
| | 7: | 10.2 | ↗ |
| | 8: | 10.8x | ↗ |
| | 9: | 10.7x | ↑ |
| | 10: | 10.6x | ← |
| | Serie | | 99.0 |
| Total | | 99.0 | |

| | | | |
|--|--------------|--------------|-------------|
| 20 Skud  | 11: | 10.5 | ↗ |
| | 12: | 9.9 | ← |
| | 13: | 10.4 | → |
| | 14: | 10.6x | ↗ |
| | 15: | 10.7x | ↙ |
| | 16: | 10.6x | ↗ |
| | 17: | 10.3 | ↗ |
| | 18: | 10.7x | ↑ |
| | 19: | 10.4 | ← |
| | 20: | 10.8x | ← |
| | Serie | | 99.0 |
| Total | | 198.0 | |

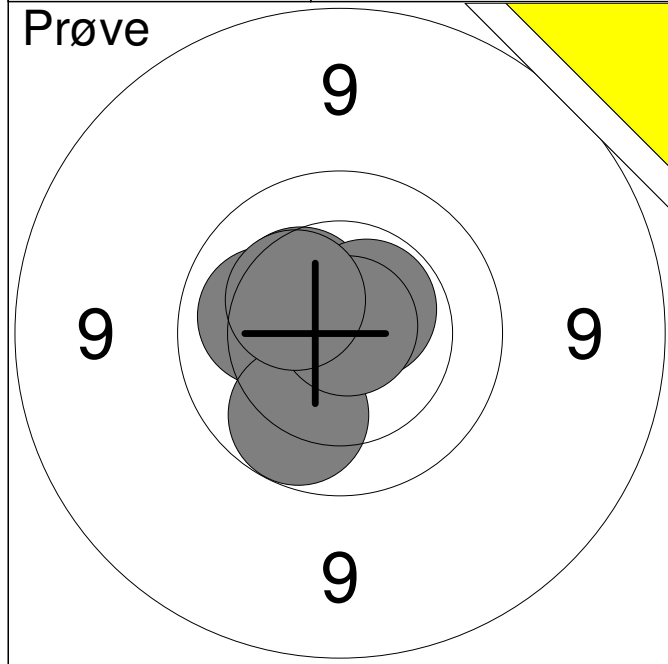

| | | |
|--------------|-------|-------------|
| 1: | 10.4 | ↗ |
| 2: | 10.6x | ↗ |
| 3: | 10.1 | ↖ |
| 4: | 10.0 | ↘ |
| 5: | 10.8x | ↗ |
| 6: | 10.3 | ↗ |
| Serie | | 60.0 |
| Total | | 0.0 |

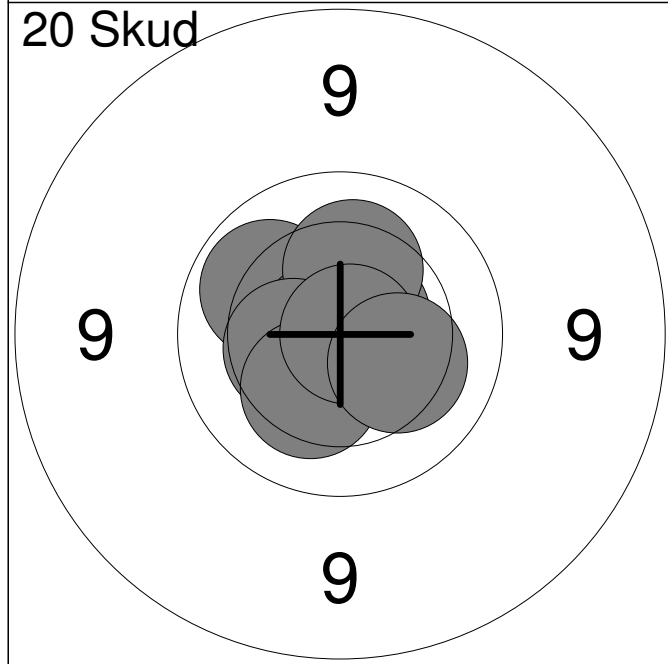

| | | |
|--------------|-------|--------------|
| 1: | 10.1 | ↗ |
| 2: | 10.5x | ↘ |
| 3: | 10.7x | ↗ |
| 4: | 10.8x | ↖ |
| 5: | 10.8x | ↗ |
| 6: | 10.2 | ↗ |
| 7: | 10.4 | ↖ |
| 8: | 10.3 | ↘ |
| 9: | 10.8x | → |
| 10: | 10.3 | ↘ |
| Serie | | 100.0 |
| Total | | 100.0 |

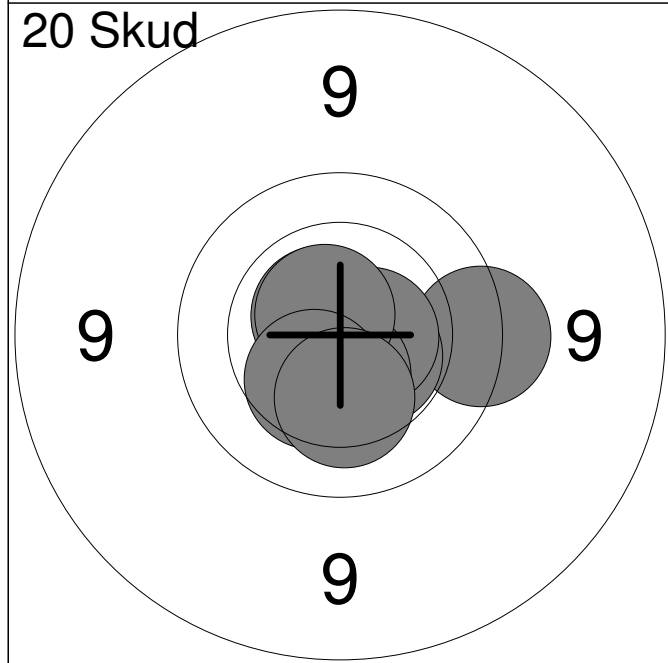

| | | |
|--------------|-------|--------------|
| 11: | 10.7x | ↘ |
| 12: | 9.7 | → |
| 13: | 10.5x | ↘ |
| 14: | 10.7x | ↘ |
| 15: | 10.7x | ↗ |
| 16: | 10.6x | → |
| 17: | 10.5x | ↘ |
| 18: | 10.7x | ↗ |
| 19: | 10.4 | ↘ |
| 20: | 10.3 | ↘ |
| Serie | | 99.0 |
| Total | | 199.0 |

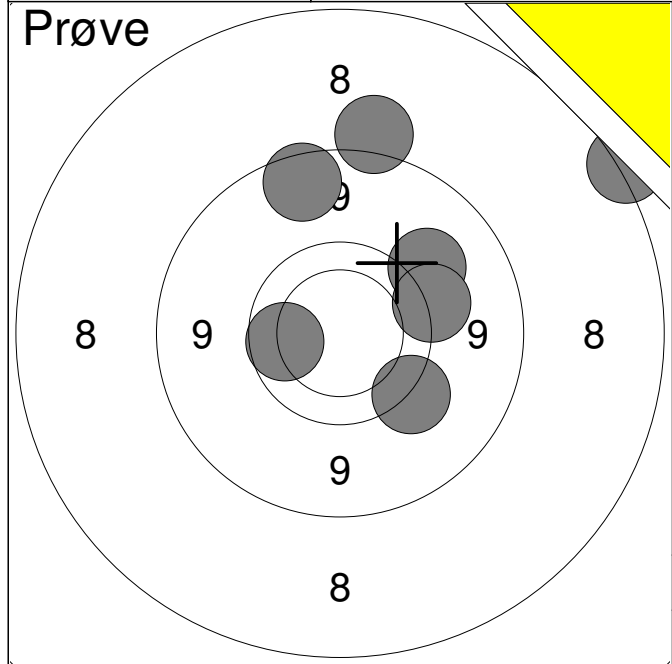

| | | |
|--------------|-----|-------------|
| 1: | 9.3 | ↗ |
| 2: | 7.6 | ↗ |
| 3: | 8.9 | ↑ |
| 4: | 9.9 | ← |
| 5: | 9.5 | ↘ |
| 6: | 8.5 | ↑ |
| 7: | 9.5 | → |
| Serie | | 59.0 |
| Total | | 0.0 |

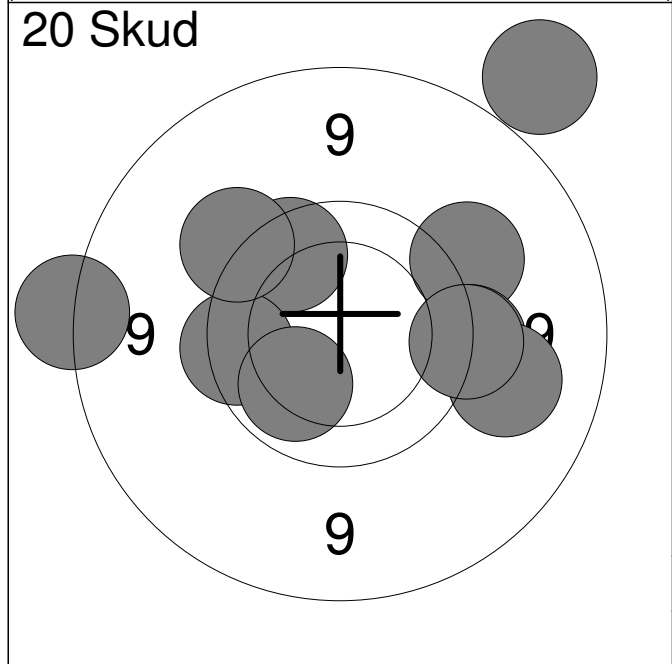

| | | |
|--------------|------|-------------|
| 1: | 9.4 | ↗ |
| 2: | 8.7 | ← |
| 3: | 8.4 | ↗ |
| 4: | 9.8 | ↗ |
| 5: | 9.5 | → |
| 6: | 9.2 | → |
| 7: | 9.7 | ← |
| 8: | 9.5 | ↗ |
| 9: | 9.6 | → |
| 10: | 10.1 | ↙ |
| Serie | | 89.0 |
| Total | | 89.0 |

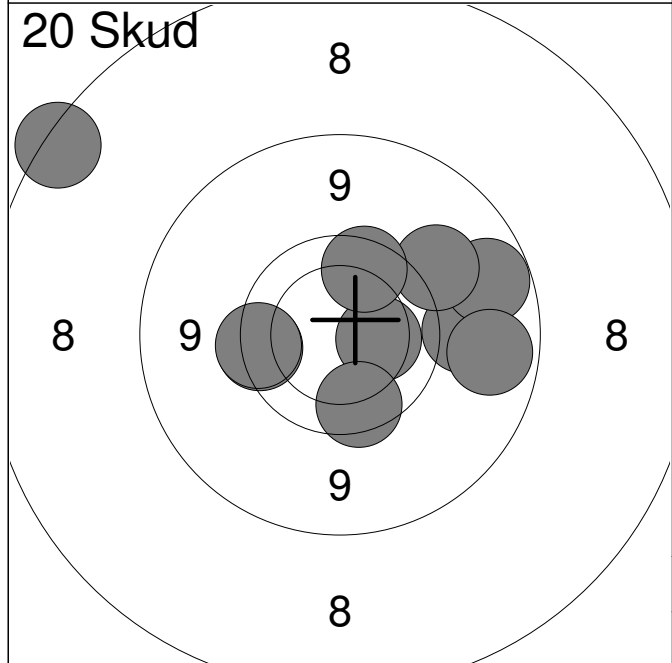

| | | |
|--------------|------|--------------|
| 11: | 9.3 | → |
| 12: | 9.0 | → |
| 13: | 9.3 | ↗ |
| 14: | 10.3 | → |
| 15: | 9.8 | ↘ |
| 16: | 7.8 | ↗ |
| 17: | 9.7 | ← |
| 18: | 9.8 | ↑ |
| 19: | 9.0 | → |
| 20: | 9.7 | ← |
| Serie | | 89.0 |
| Total | | 178.0 |

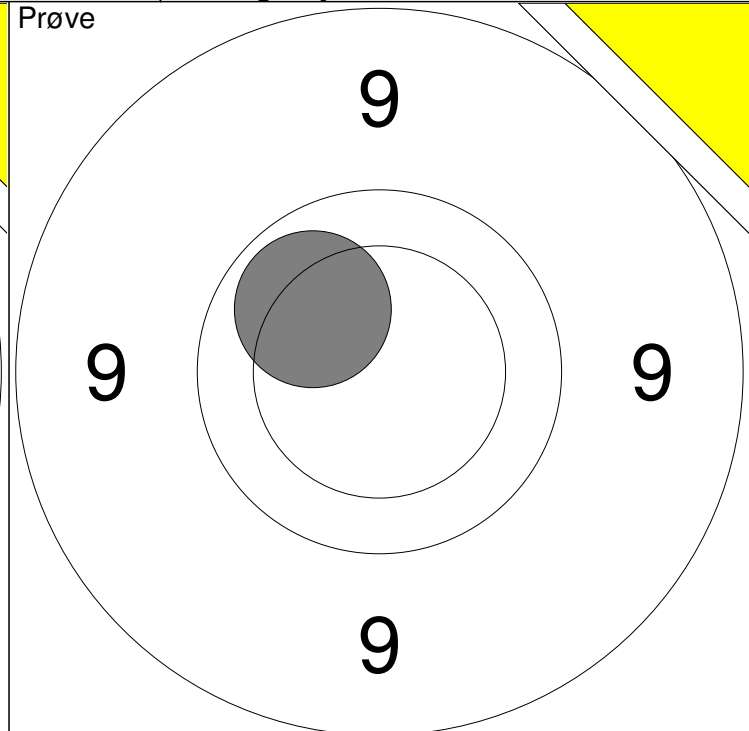
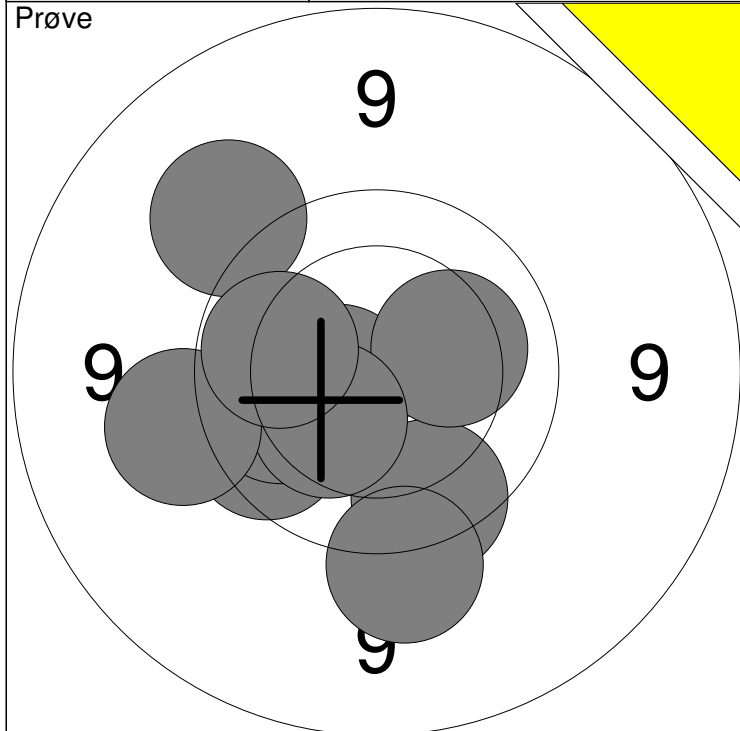

| | | |
|------------|------------|-----------------|
| 1: 9.8 ↙ | 6: 9.4 ↓ | Serie 95 |
| 2: 10.6x ↙ | 7: 10.0 ↙ | |
| 3: 9.8 ↓ | 8: 10.3 ↙ | Total 0 |
| 4: 10.2 → | 9: 9.4 ↙ | |
| 5: 9.3 ↗ | 10: 10.0 ↙ | |

| | |
|------------|-----------------|
| 11: 10.1 ↗ | Serie 10 |
| | |
| | Total 0 |

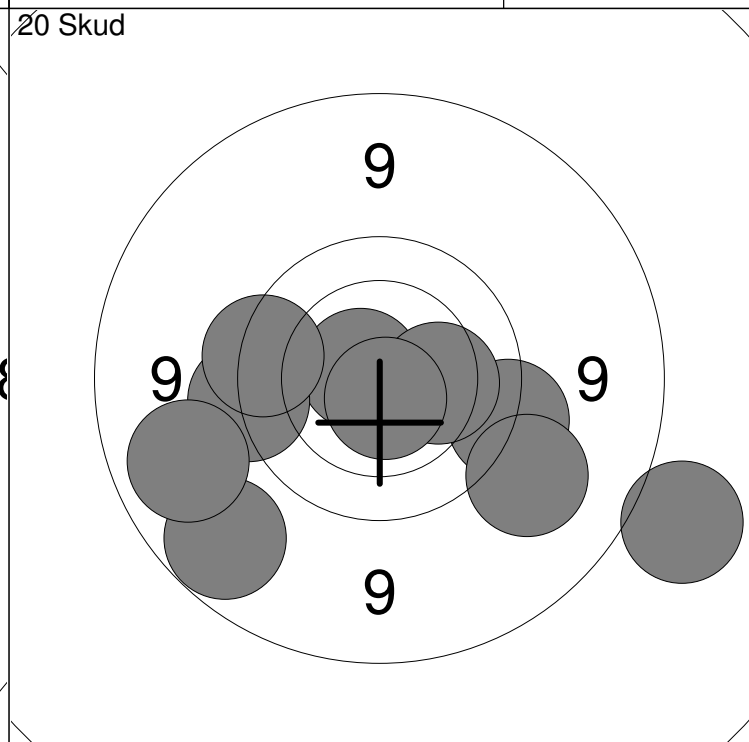
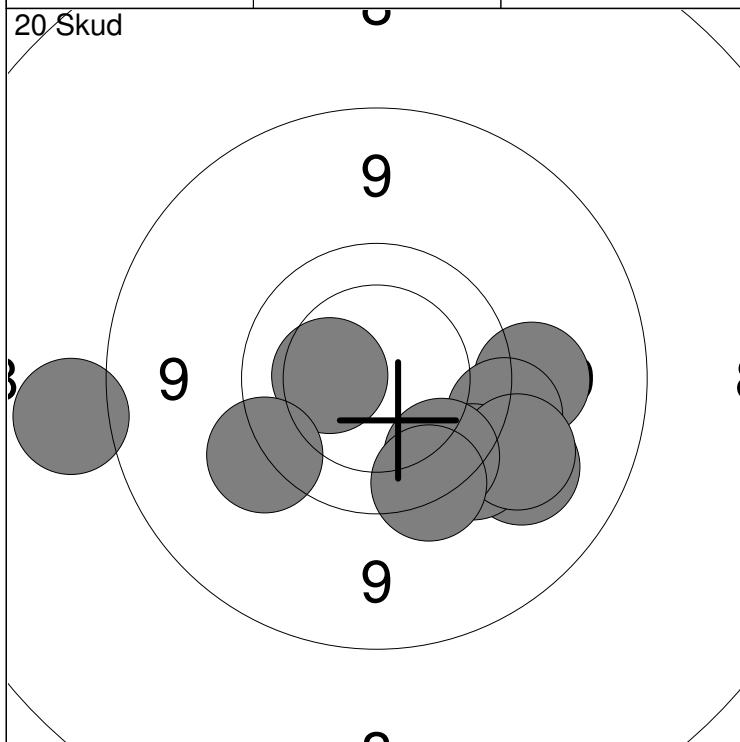

| | | |
|----------|-----------|-----------------|
| 1: 9.4 → | 6: 10.3 ↙ | Serie 90 |
| 2: 9.5 → | 7: 9.8 ↓ | |
| 3: 9.3 ↓ | 8: 9.5 ↙ | Total 90 |
| 4: 9.6 ↓ | 9: 9.7 ↓ | |
| 5: 9.3 ↓ | 10: 8.5 ↙ | |

| | | |
|-------------|-------------|------------------|
| 11: 10.7x ↗ | 16: 9.7 ↙ | Serie 92 |
| 12: 9.6 → | 17: 10.2 → | |
| 13: 9.3 ↓ | 18: 10.7x ↓ | Total 182 |
| 14: 9.6 ↙ | 19: 8.4 ↗ | |
| 15: 9.0 ↙ | 20: 9.1 ↙ | |

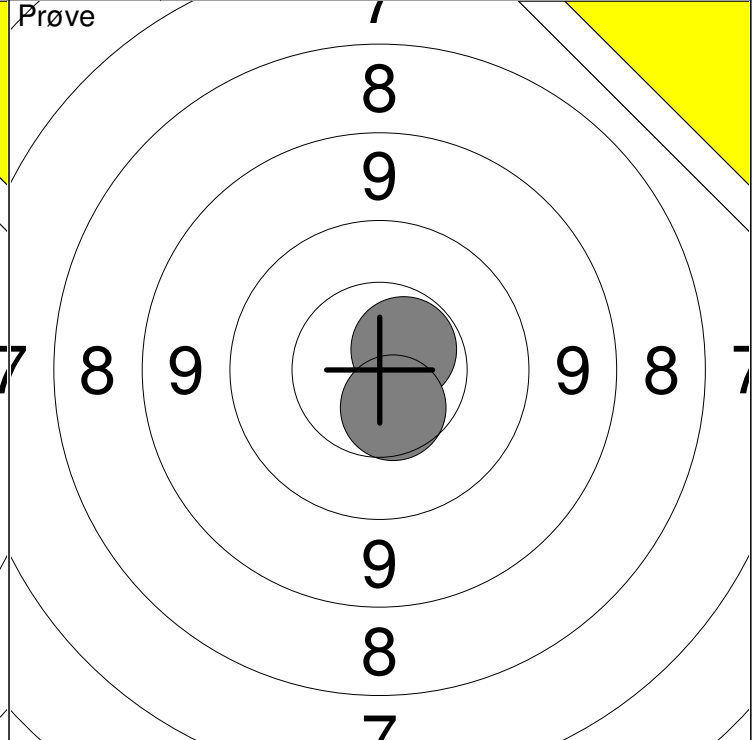
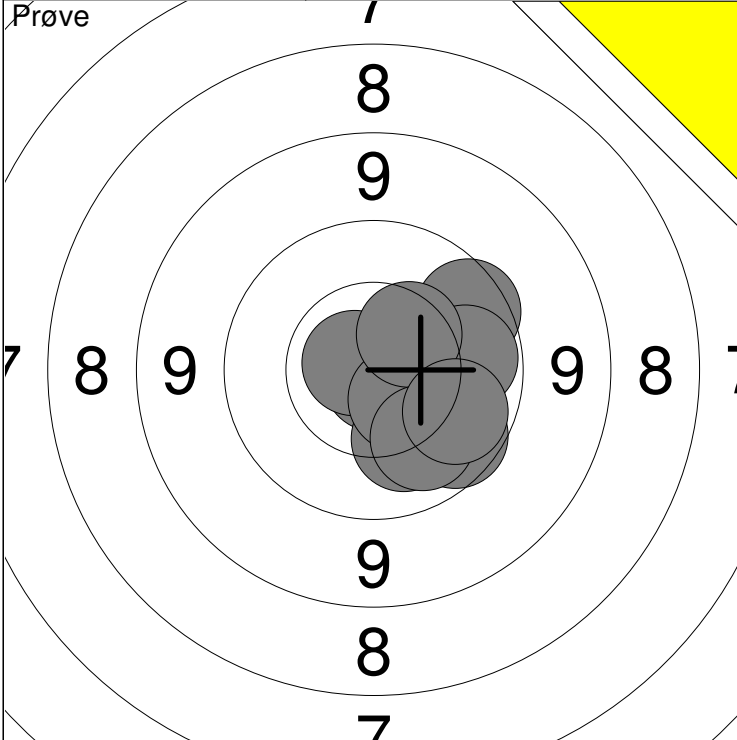

| | | |
|------------|------------|----------|
| 1: 10.9x ↓ | 6: 9.9 ↓ | Serie 98 |
| 2: 10.7x ← | 7: 10.5 ↓ | |
| 3: 10.2 ↓ | 8: 10.4 ↗ | Total 0 |
| 4: 9.8 ↗ | 9: 10.1 ↓ | |
| 5: 10.0 → | 10: 10.0 ↓ | |

| | |
|-------------|----------|
| 11: 10.6x ↗ | Serie 20 |
| 12: 10.5 ↓ | |
| Total 0 | |

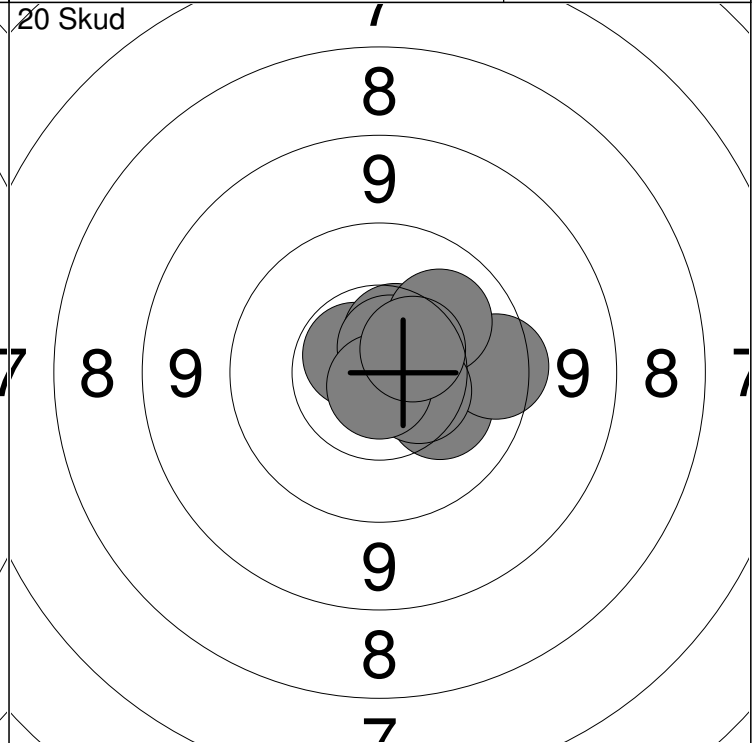
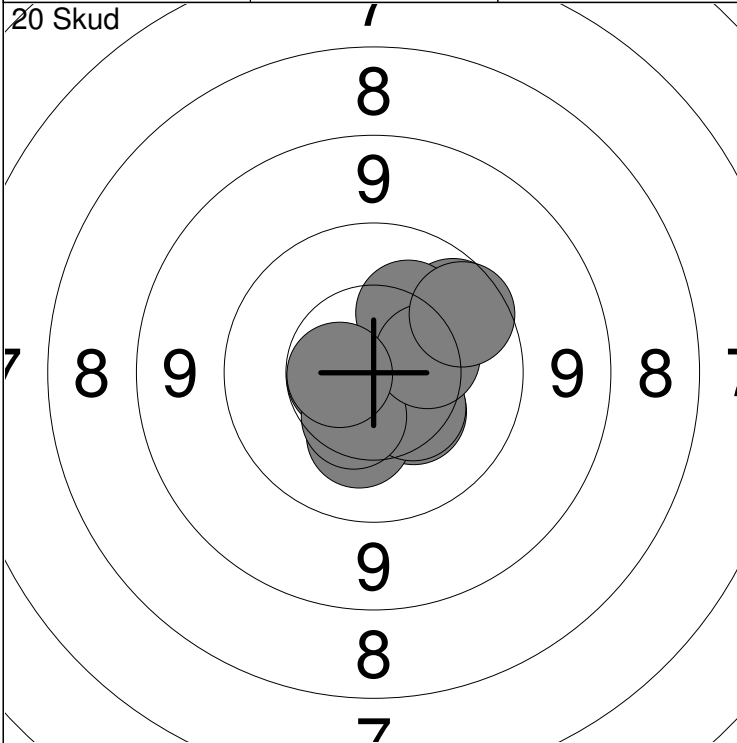

| | | |
|------------|------------|----------|
| 1: 10.6x ← | 6: 10.4 ↓ | Serie 98 |
| 2: 10.4 ↓ | 7: 10.5 ↓ | |
| 3: 9.9 ↗ | 8: 10.4 → | Total 98 |
| 4: 10.2 ↗ | 9: 10.6x ← | |
| 5: 10.3 ↓ | 10: 9.9 ↗ | |

| | | |
|-------------|-------------|-----------|
| 11: 10.6x ↗ | 16: 9.7 → | Serie 99 |
| 12: 10.5 ↗ | 17: 10.1 ↗ | |
| 13: 10.8x ↗ | 18: 10.5 → | Total 197 |
| 14: 10.7x ↗ | 19: 10.8x ↓ | |
| 15: 10.2 ↓ | 20: 10.5 ↗ | |

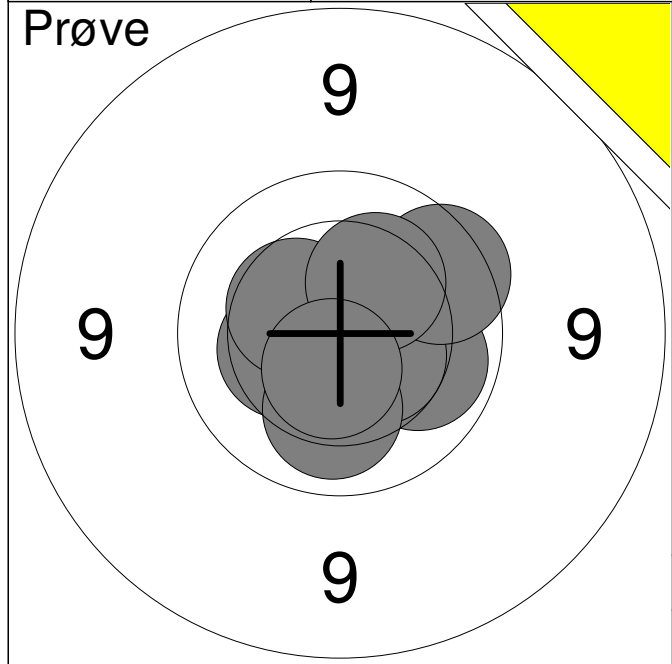

| | | |
|--------------|-------|-------------|
| 1: | 10.7x | ↑ |
| 2: | 10.4 | ← |
| 3: | 10.4 | ↗ |
| 4: | 10.1 | ↘ |
| 5: | 10.5x | → |
| 6: | 10.5x | ↙ |
| 7: | 9.8 | ↗ |
| 8: | 10.3 | ↗ |
| 9: | 10.1 | ↓ |
| 10: | 10.6x | ↓ |
| Serie | | 99.0 |
| Total | | 0.0 |

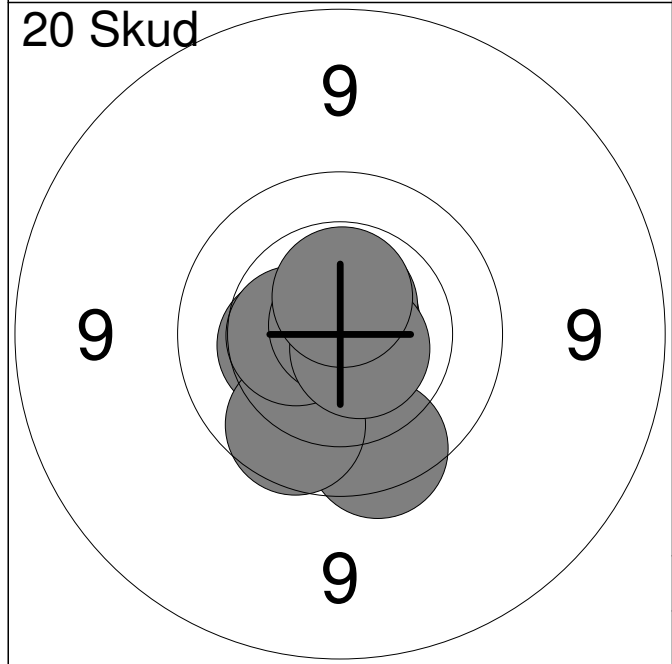

| | | |
|--------------|-------|-------------|
| 1: | 10.7x | ↙ |
| 2: | 10.4 | ← |
| 3: | 9.8 | ↓ |
| 4: | 9.9 | ↙ |
| 5: | 10.8x | ↗ |
| 6: | 10.5 | ← |
| 7: | 10.6x | ↗ |
| 8: | 10.8x | ↗ |
| 9: | 10.7x | ↘ |
| 10: | 10.5x | ↑ |
| Serie | | 98.0 |
| Total | | 98.0 |

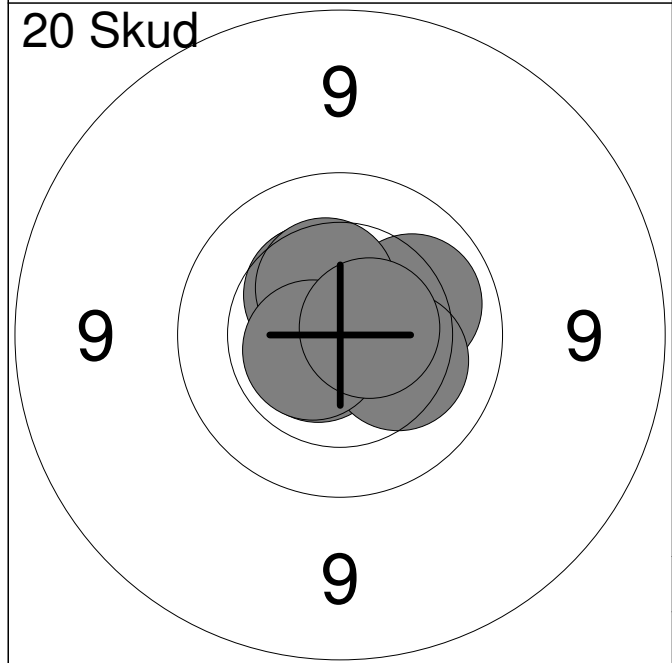

| | | |
|--------------|-------|--------------|
| 11: | 10.7x | ↗ |
| 12: | 10.4 | ↗ |
| 13: | 10.5x | ↘ |
| 14: | 10.1 | ↘ |
| 15: | 10.6x | ↙ |
| 16: | 10.4 | ↗ |
| 17: | 10.4 | ↗ |
| 18: | 10.3 | ↘ |
| 19: | 10.6x | ↙ |
| 20: | 10.6x | → |
| Serie | | 100.0 |
| Total | | 198.0 |

| | | | |
|-------------------|--------------------|-------------------------------|--|
| Hold 28 | Skive 10 | Henrik Møller Jakobsen | |
|-------------------|--------------------|-------------------------------|--|

| | | |
|-----|---------------------|-----|
| 15m | Vester Hassing Skf. | MÅ3 |
|-----|---------------------|-----|

| | | |
|--|---------------------------------|---------------------|
| | 15 meter riffelstævne oktober 2 | Aalborg Skyttekreds |
|--|---------------------------------|---------------------|

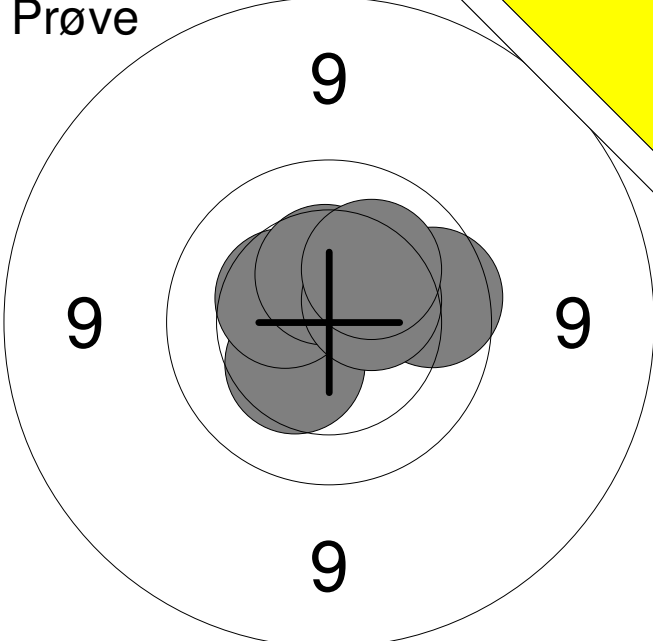
| | | | |
|--|--------------|------|------------|
| Prøve  | 1: | 10.4 | ↙ |
| | 2: | 10.4 | ↖ |
| | 3: | 9.9 | → |
| | 4: | 10.4 | ↑ |
| | 5: | 10.4 | ↗ |
| | 6: | 10.2 | ↗ |
| | Serie | | |
| Total | | | 0.0 |

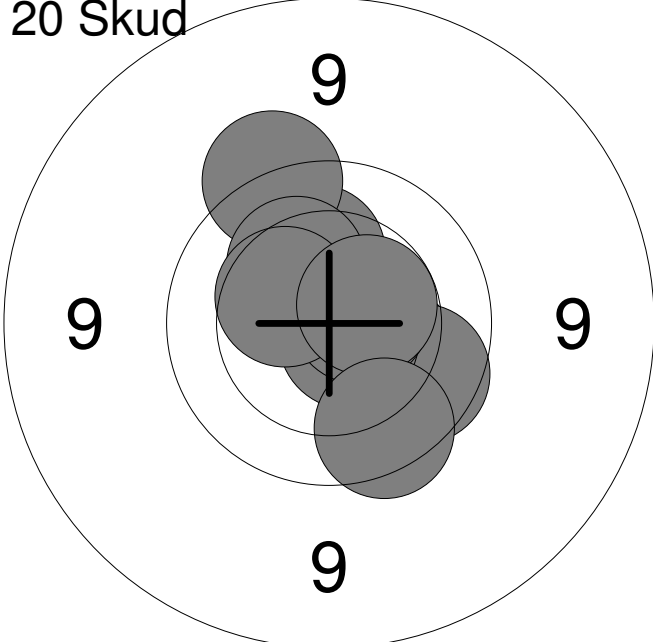
| | | | |
|---|--------------|-------|-------------|
| 20 Skud  | 1: | 10.2 | ↑ |
| | 2: | 9.6 | ↗ |
| | 3: | 10.2 | ↘ |
| | 4: | 9.9 | ↘ |
| | 5: | 10.2 | ↗ |
| | 6: | 10.7x | ↘ |
| | 7: | 10.6x | → |
| | 8: | 10.4 | ↗ |
| | 9: | 10.5x | → |
| | 10: | 9.8 | ↓ |
| | Serie | | |
| Total | | | 97.0 |

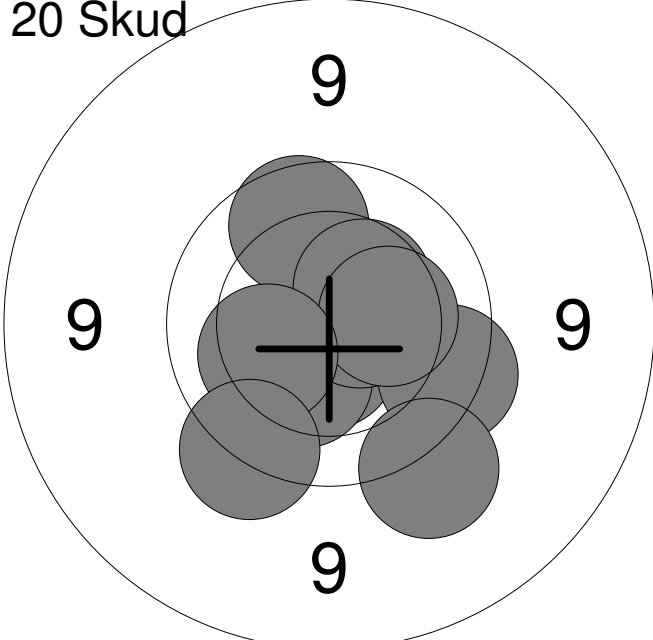
| | | | |
|--|--------------|-------|--------------|
| 20 Skud  | 11: | 9.9 | ↑ |
| | 12: | 10.6x | ↓ |
| | 13: | 9.7 | ↘ |
| | 14: | 10.3 | ↘ |
| | 15: | 10.6x | → |
| | 16: | 10.4 | ↗ |
| | 17: | 10.3 | → |
| | 18: | 10.2 | ↖ |
| | 19: | 9.4 | ↓ |
| | 20: | 9.6 | ↙ |
| | Serie | | |
| Total | | | 193.0 |

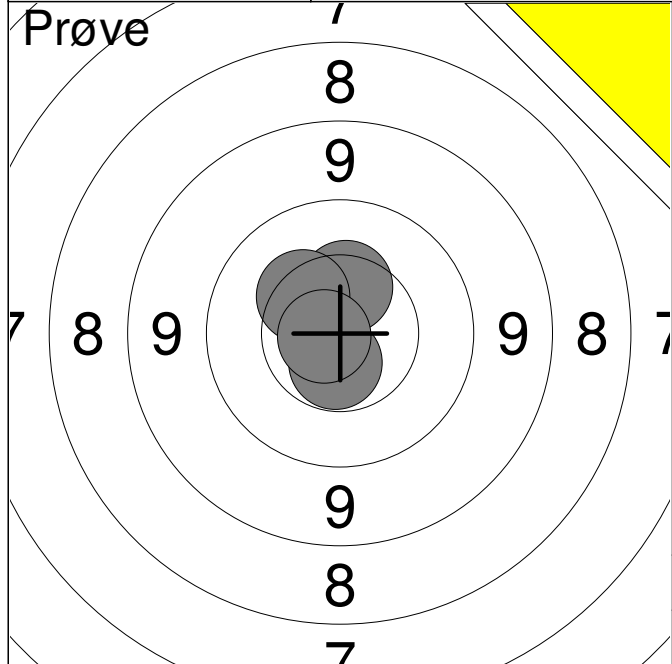

| | | | |
|--------------|----|-------|-------------|
| | 1: | 10.6x | ↓ |
| | 2: | 10.4 | ↑ |
| | 3: | 10.3 | ↗ |
| | 4: | 10.8x | ← |
| Serie | | | 40.0 |
| Total | | | 0.0 |

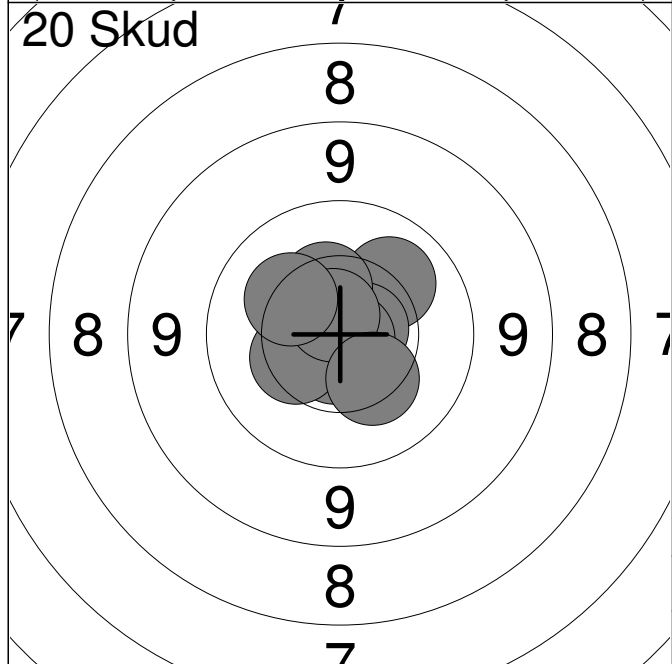

| | | | |
|--------------|-----|-------|--------------|
| | 1: | 10.1 | ↗ |
| | 2: | 10.7x | → |
| | 3: | 10.4 | ↑ |
| | 4: | 10.8x | ↘ |
| | 5: | 10.7x | ← |
| | 6: | 10.7x | ↓ |
| | 7: | 10.4 | ↖ |
| | 8: | 10.7x | ↑ |
| | 9: | 10.3 | ↘ |
| | 10: | 10.3 | ↗ |
| Serie | | | 100.0 |
| Total | | | 100.0 |

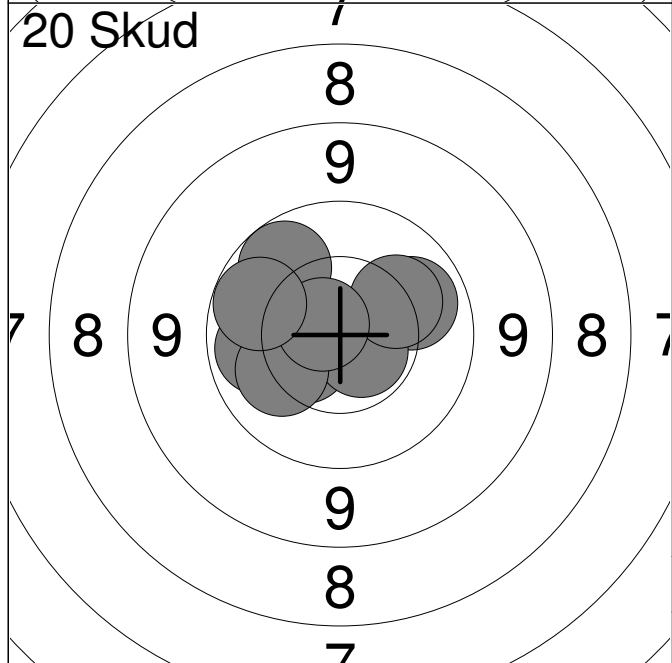

| | | | |
|--------------|-----|-------|--------------|
| | 11: | 10.5 | ↖ |
| | 12: | 10.7x | ↘ |
| | 13: | 10.0 | ← |
| | 14: | 10.0 | → |
| | 15: | 10.6x | ↘ |
| | 16: | 9.9 | ↗ |
| | 17: | 10.2 | ↖ |
| | 18: | 10.2 | ↗ |
| | 19: | 10.7x | ↗ |
| | 20: | 10.0 | ↖ |
| Serie | | | 99.0 |
| Total | | | 199.0 |

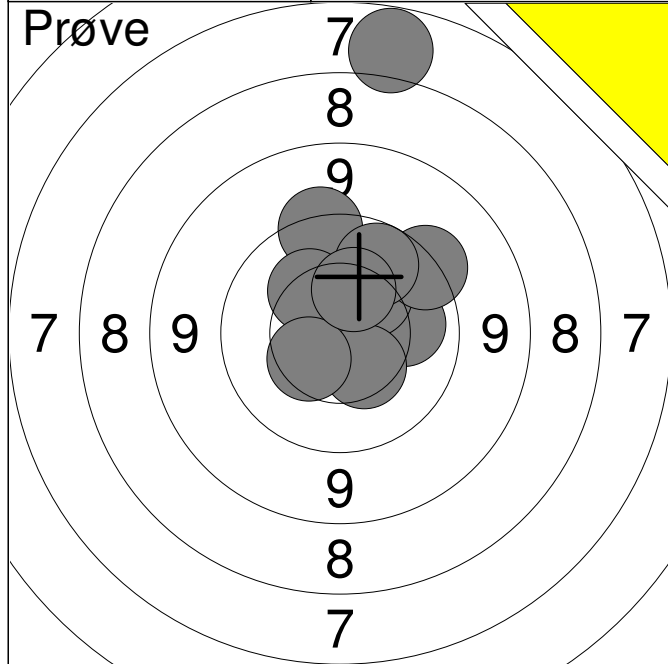

| | | |
|-----|------|---|
| 1: | 7.0 | ↑ |
| 2: | 9.5 | ↑ |
| 3: | 10.1 | → |
| 4: | 10.3 | ↖ |
| 5: | 10.3 | ↗ |
| 6: | 9.5 | ↗ |
| 7: | 10.0 | ↗ |
| 8: | 10.4 | ↘ |
| 9: | 10.4 | ↖ |
| 10: | 10.4 | ↑ |

| | |
|--------------|-------------|
| Serie | 95.0 |
| Total | 0.0 |

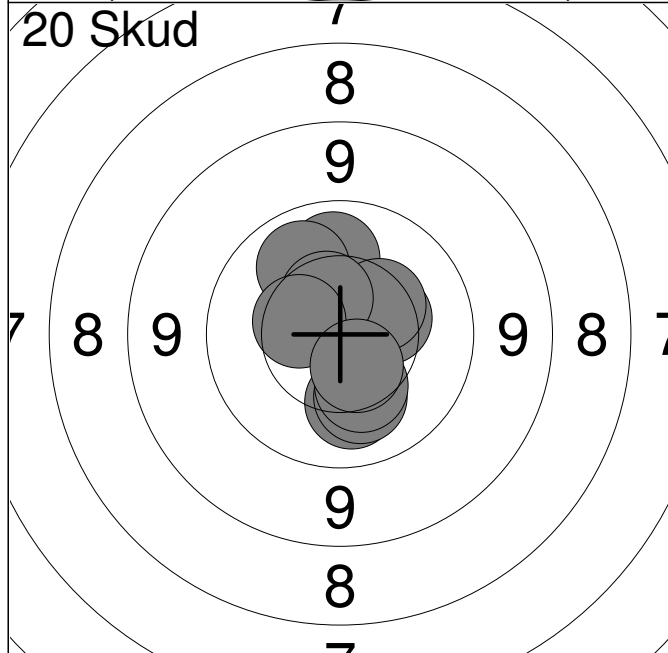

| | | |
|-----|------|---|
| 1: | 10.4 | → |
| 2: | 10.1 | ↑ |
| 3: | 10.2 | ↘ |
| 4: | 10.2 | ↘ |
| 5: | 10.3 | ↘ |
| 6: | 10.1 | ↗ |
| 7: | 10.4 | ↗ |
| 8: | 10.5 | ↗ |
| 9: | 10.5 | ↖ |
| 10: | 10.5 | ↘ |

| | |
|--------------|--------------|
| Serie | 100.0 |
| Total | 100.0 |

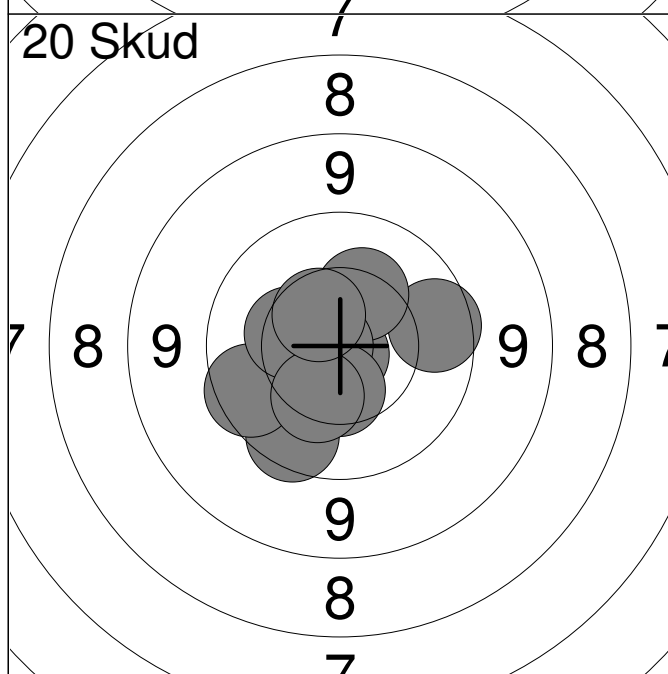

| | | |
|-----|-------|---|
| 11: | 9.8 | → |
| 12: | 9.8 | ↘ |
| 13: | 10.9x | ↘ |
| 14: | 9.8 | ↖ |
| 15: | 10.3 | ↗ |
| 16: | 10.8x | ← |
| 17: | 10.4 | ↘ |
| 18: | 10.4 | ↖ |
| 19: | 10.3 | ↘ |
| 20: | 10.5 | ↗ |

| | |
|--------------|--------------|
| Serie | 97.0 |
| Total | 197.0 |

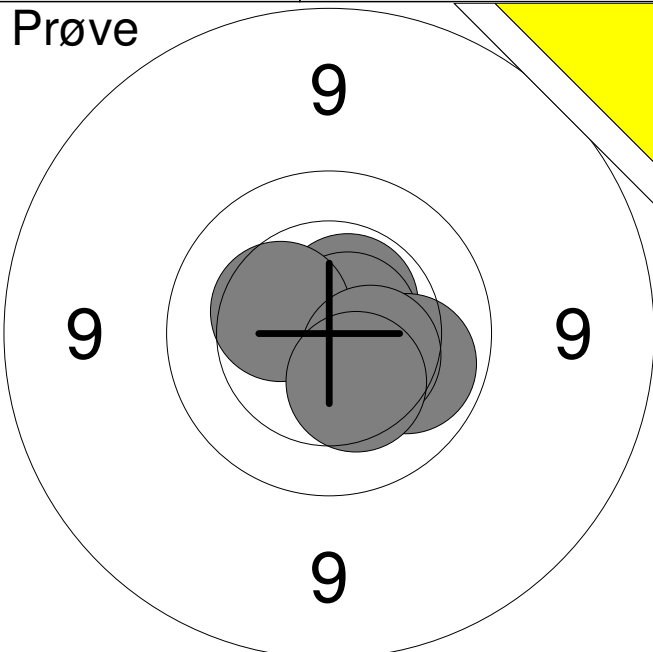
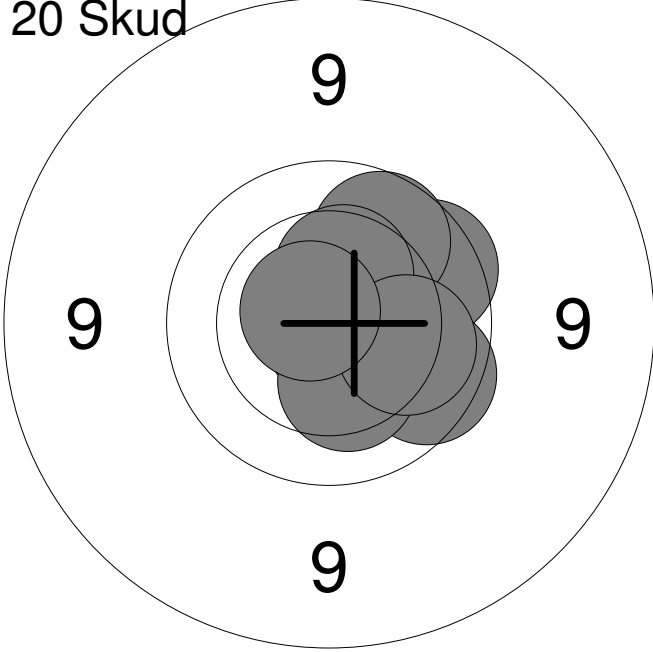
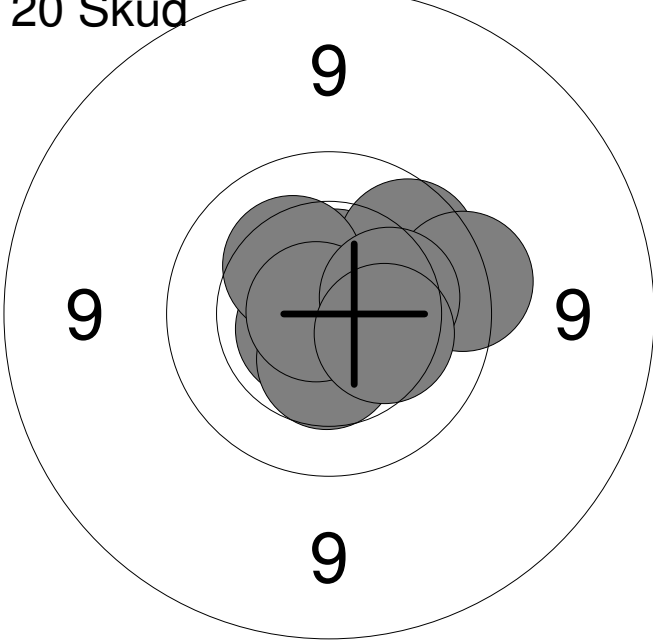
| Hold | Skive | | |
|---------|--|---------------------|--|
| 29 | 1 | Susanne Svendsen | |
| 15m | Vester Hassing Skf. | MÅ3 | |
| | 15 meter riffelstævne oktober 2 | Aalborg Skyttekreds | |
| Prøve |  | 1: 10.6x ↗ | |
| | | 2: 10.7x ↗ | |
| | | 3: 10.4 ↗ | |
| | | 4: 10.1 ↘ | |
| | | 5: 10.4 ↘ | |
| | | 6: 10.4 ↘ | |
| | Serie | 60.0 | |
| | Total | 0.0 | |
| 20 Skud |  | 1: 9.8 ↗ | |
| | | 2: 10.5 ↗ | |
| | | 3: 10.9x ↘ | |
| | | 4: 10.7x ↘ | |
| | | 5: 9.8 ↘ | |
| | | 6: 10.3 ↘ | |
| | | 7: 9.9 ↗ | |
| | | 8: 10.4 ↗ | |
| | | 9: 10.1 ↘ | |
| | | 10: 10.7x ↗ | |
| | Serie | 97.0 | |
| | Total | 97.0 | |
| 20 Skud |  | 11: 10.0 ↗ | |
| | | 12: 10.6x ↑ | |
| | | 13: 9.9 ↗ | |
| | | 14: 9.7 → | |
| | | 15: 10.7x ↙ | |
| | | 16: 10.3 ↗ | |
| | | 17: 10.5 ↘ | |
| | | 18: 10.8x ← | |
| | | 19: 10.3 → | |
| | | 20: 10.3 ↘ | |
| | Serie | 98.0 | |
| | Total | 195.0 | |

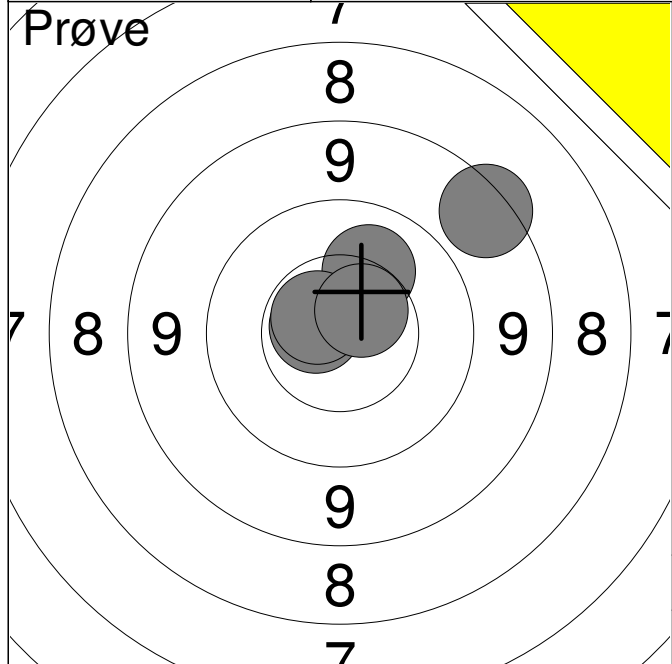

| | | |
|--------------|-------|-------------|
| 1: | 8.6 | ↗ |
| 2: | 10.7x | ↖ |
| 3: | 10.2 | ↗ |
| 4: | 10.6x | ↖ |
| 5: | 10.6x | ↗ |
| Serie | | 48.0 |
| Total | | 0.0 |

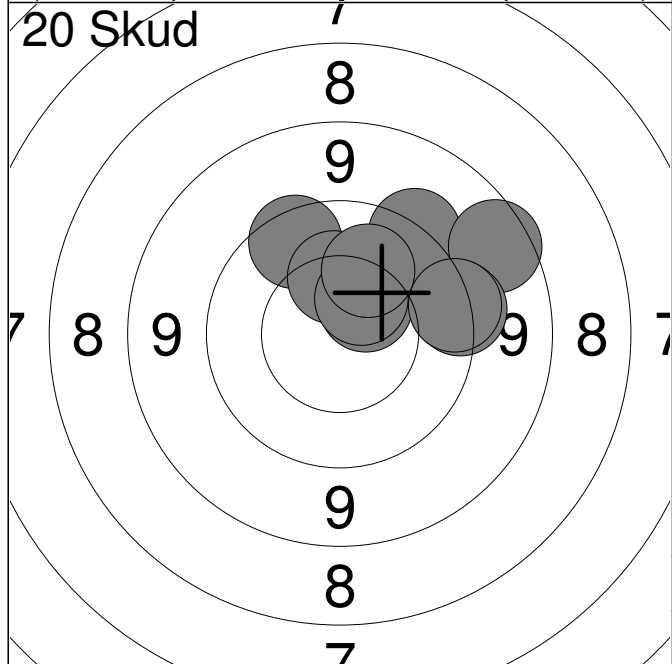

| | | |
|--------------|------|-------------|
| 1: | 9.5 | ↗ |
| 2: | 9.7 | ↖ |
| 3: | 8.8 | ↗ |
| 4: | 9.5 | → |
| 5: | 10.5 | ↗ |
| 6: | 10.3 | ↑ |
| 7: | 10.5 | ↗ |
| 8: | 9.5 | → |
| 9: | 9.5 | → |
| 10: | 10.1 | ↗ |
| Serie | | 93.0 |
| Total | | 93.0 |

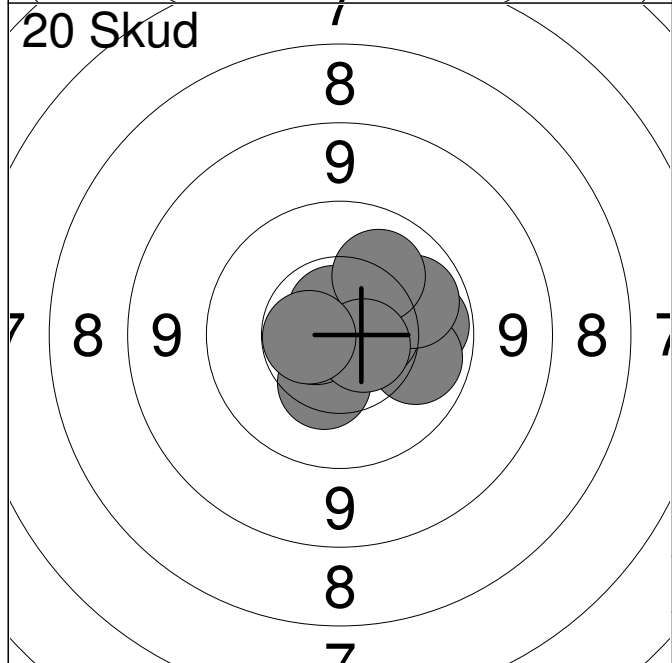

| | | |
|--------------|-------|--------------|
| 11: | 10.0 | → |
| 12: | 10.0 | → |
| 13: | 10.6 | → |
| 14: | 10.4 | ↓ |
| 15: | 10.0 | ↗ |
| 16: | 10.7x | ↖ |
| 17: | 10.7x | ↑ |
| 18: | 10.1 | ↗ |
| 19: | 10.7x | → |
| 20: | 10.6x | ↖ |
| Serie | | 100.0 |
| Total | | 193.0 |

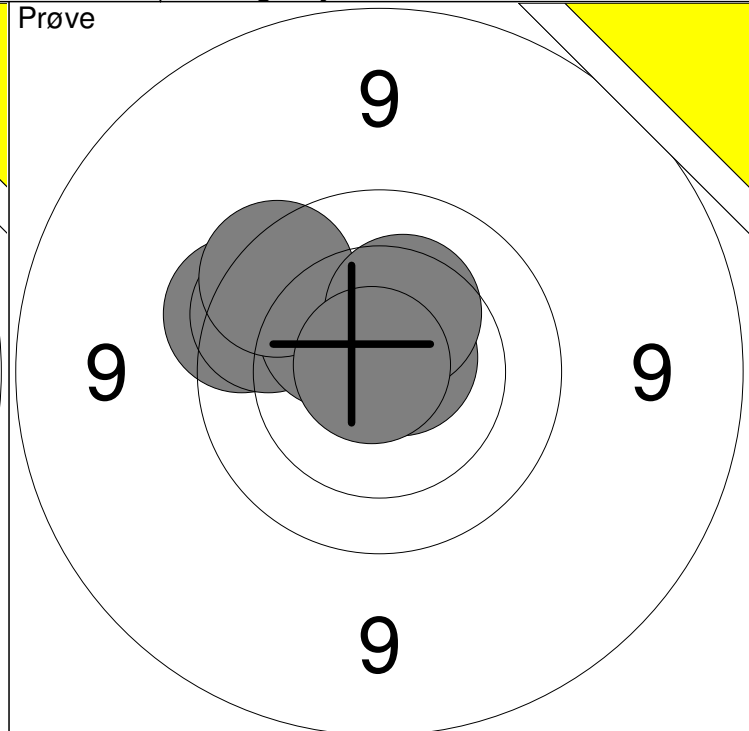
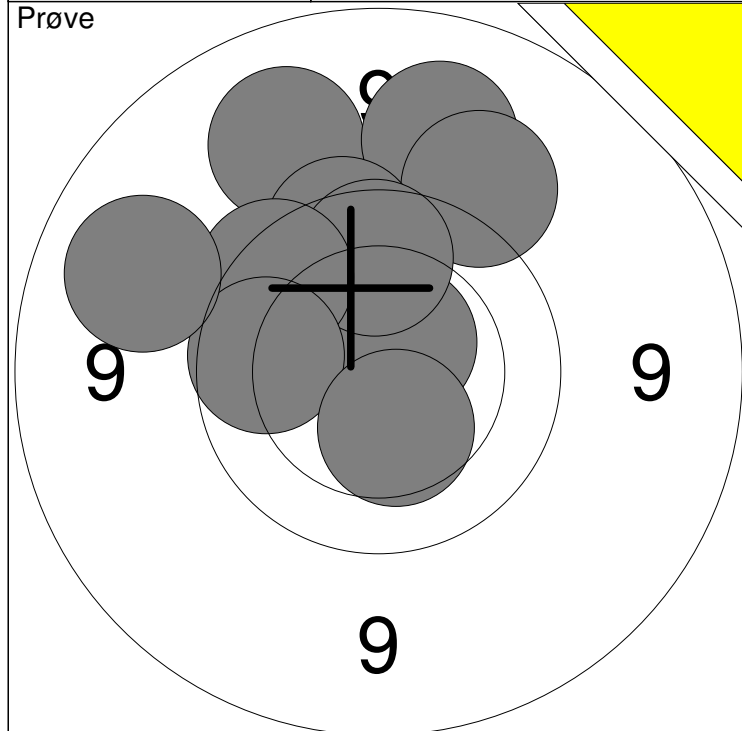

| | | | |
|------------|-----------|-------|----|
| 1: 10.6x ↗ | 6: 9.9 ↑ | Serie | 92 |
| 2: 9.2 ↑ | 7: 9.8 ↗ | | |
| 3: 9.2 ↑ | 8: 9.9 ← | Total | 0 |
| 4: 9.4 ↗ | 9: 10.4 ↓ | | |
| 5: 9.7 ↑ | 10: 9.1 ↗ | | |

| | | | |
|-------------|-------------|-------|----|
| 11: 10.7x ↗ | 16: 10.3 ↑ | Serie | 67 |
| 12: 9.7 ↗ | 17: 10.9x ↖ | | |
| 13: 9.8 ↗ | | Total | 0 |
| 14: 10.4 ↗ | | | |
| 15: 9.8 ↗ | | | |

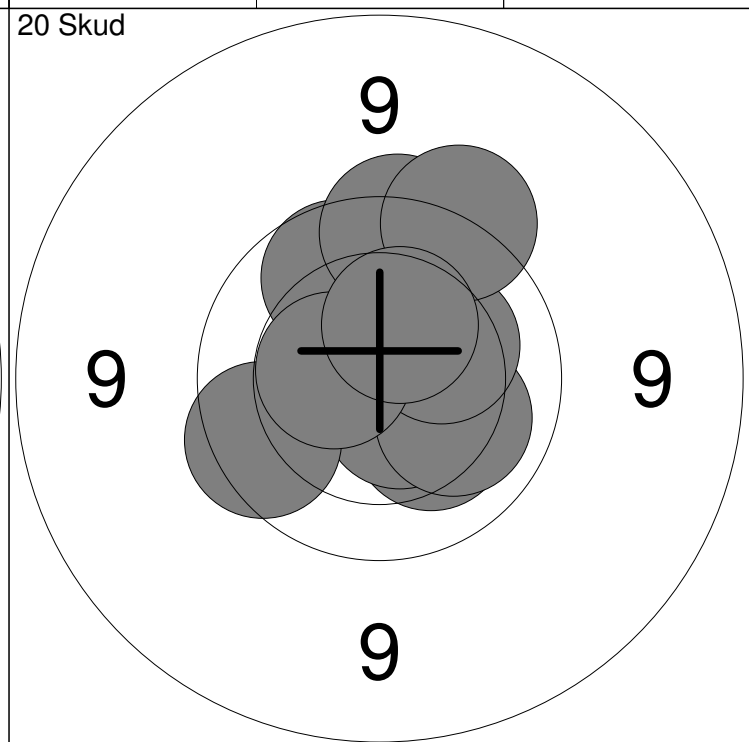
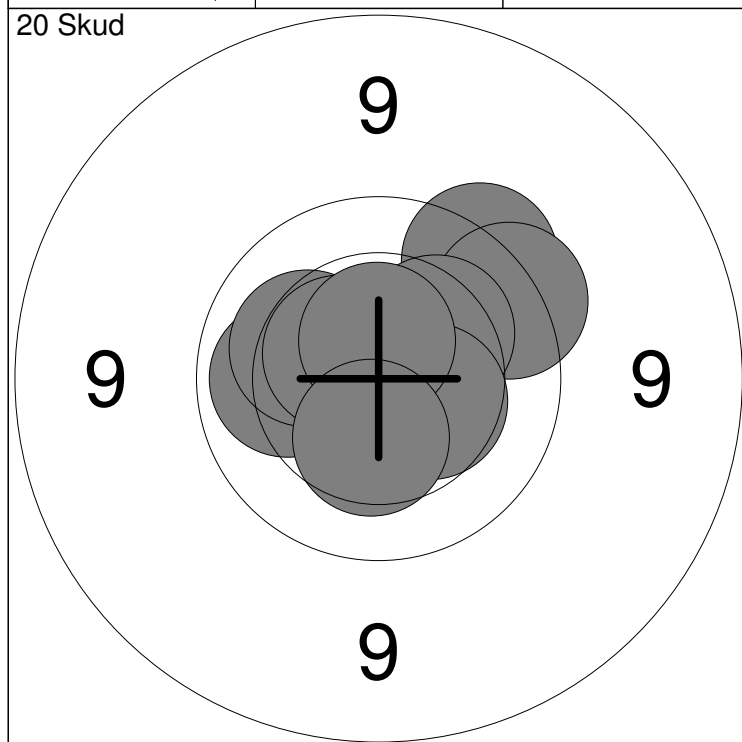

| | | | |
|------------|------------|-------|----|
| 1: 9.7 ↗ | 6: 10.2 ↗ | Serie | 98 |
| 2: 9.7 ↗ | 7: 10.5x ↖ | | |
| 3: 10.1 ← | 8: 10.4 → | Total | 98 |
| 4: 10.2 ↖ | 9: 10.6x ↑ | | |
| 5: 10.6x ↓ | 10: 10.4 ↓ | | |

| | | | |
|-------------|-------------|-------|-----|
| 11: 10.2 ↓ | 16: 10.3 ↗ | Serie | 96 |
| 12: 9.9 ↑ | 17: 9.8 ↖ | | |
| 13: 10.6x ↓ | 18: 10.5x ← | Total | 194 |
| 14: 10.1 → | 19: 9.6 ↑ | | |
| 15: 9.7 ↑ | 20: 10.4 ↑ | | |

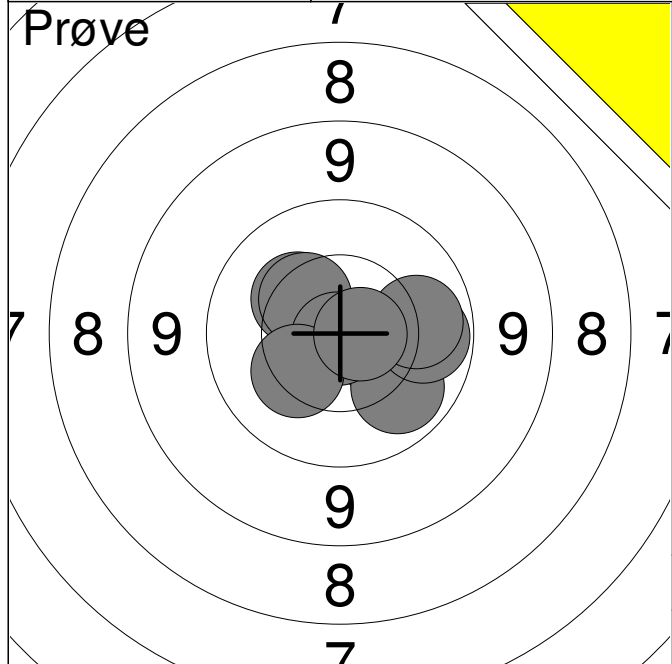

| | | |
|--------------|-------|-------------|
| 1: | 10.4 | → |
| 2: | 10.0 | ↙ |
| 3: | 10.0 | → |
| 4: | 10.3 | ↗ |
| 5: | 10.4 | ↗ |
| 6: | 10.9x | ↙ |
| 7: | 10.1 | → |
| 8: | 10.3 | ↙ |
| 9: | 10.7x | → |
| Serie | | 90.0 |
| Total | | 0.0 |

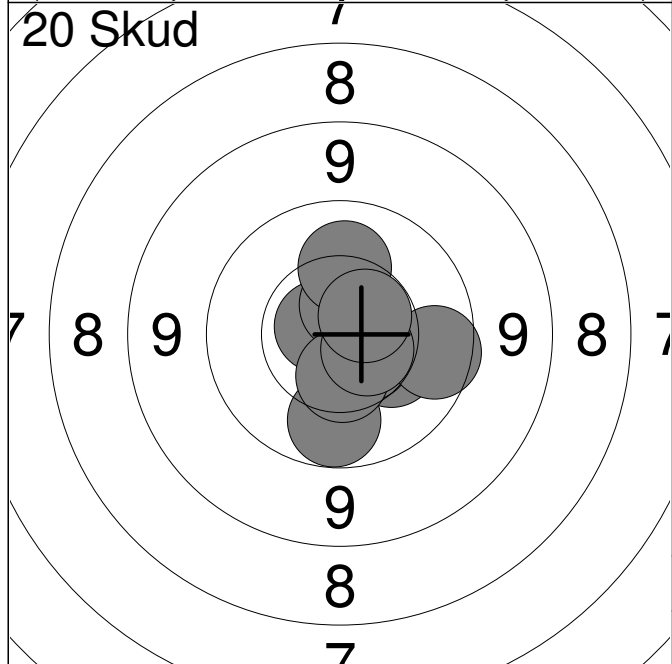

| | | |
|--------------|-------|-------------|
| 1: | 10.3 | → |
| 2: | 10.7x | ↖ |
| 3: | 10.6x | ↑ |
| 4: | 9.9 | ↓ |
| 5: | 10.6 | ↘ |
| 6: | 9.8 | → |
| 7: | 10.2 | ↑ |
| 8: | 10.5 | ↓ |
| 9: | 10.6x | ↘ |
| 10: | 10.6x | ↗ |
| Serie | | 98.0 |
| Total | | 98.0 |

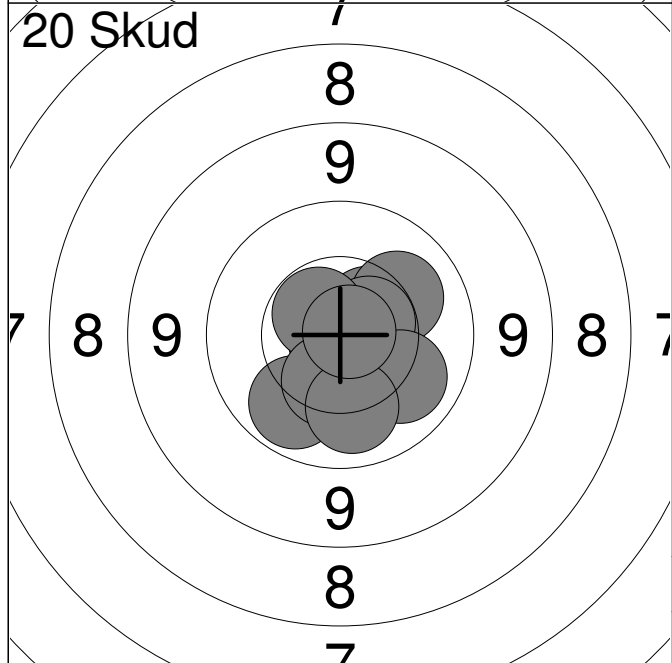

| | | |
|--------------|-------|--------------|
| 11: | 10.5 | ↗ |
| 12: | 10.0 | ↙ |
| 13: | 10.2 | ↗ |
| 14: | 10.6x | → |
| 15: | 10.1 | ↘ |
| 16: | 10.9x | ↙ |
| 17: | 10.6x | ↗ |
| 18: | 10.4 | ↓ |
| 19: | 10.1 | ↓ |
| 20: | 10.8x | → |
| Serie | | 100.0 |
| Total | | 198.0 |

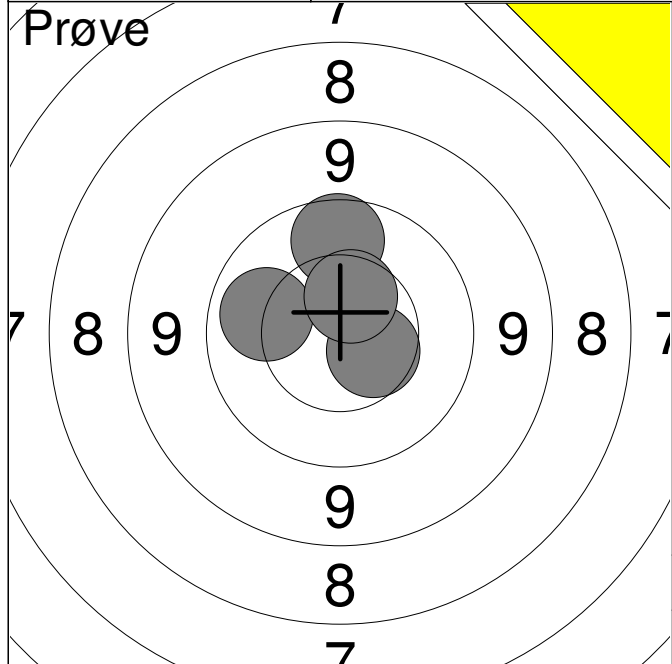

| | | |
|--------------|------|-------------|
| 1: | 9.9 | ↑ |
| 2: | 10.1 | ← |
| 3: | 10.5 | → |
| 4: | 10.5 | ↑ |
| Serie | | 39.0 |
| Total | | 0.0 |

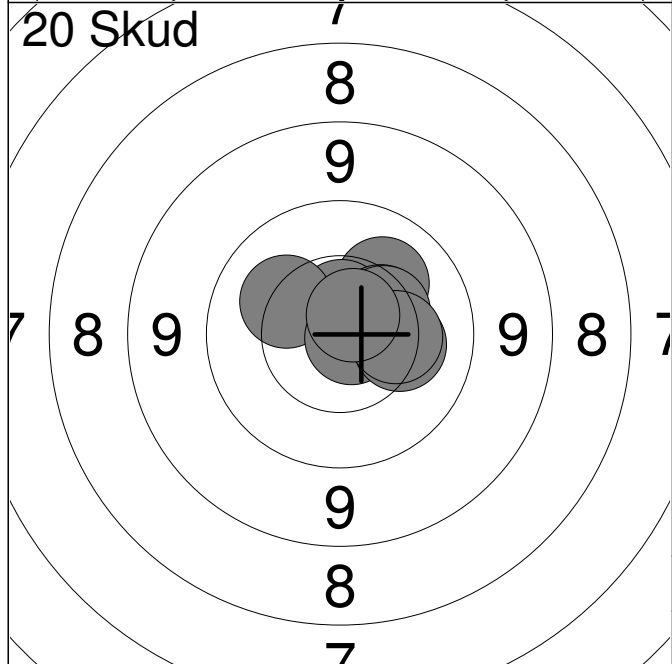

| | | |
|--------------|-------|--------------|
| 1: | 10.2 | ↗ |
| 2: | 10.6x | ↑ |
| 3: | 10.2 | ↖ |
| 4: | 10.4 | ↗ |
| 5: | 10.8x | → |
| 6: | 10.8x | ↘ |
| 7: | 10.2 | → |
| 8: | 10.4 | ↗ |
| 9: | 10.3 | → |
| 10: | 10.7x | ↗ |
| Serie | | 100.0 |
| Total | | 100.0 |

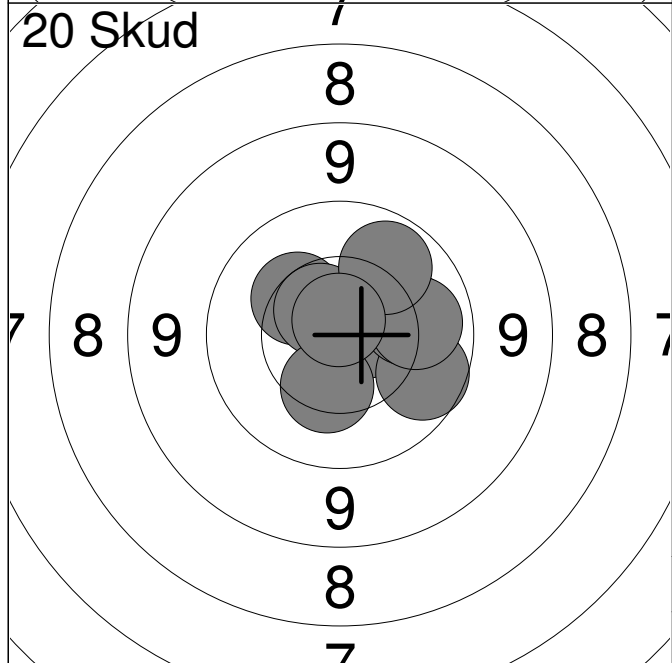

| | | |
|--------------|-------|--------------|
| 11: | 10.3 | ↖ |
| 12: | 10.7x | ↗ |
| 13: | 10.7x | → |
| 14: | 9.9 | ↘ |
| 15: | 10.6x | ↗ |
| 16: | 10.2 | → |
| 17: | 10.1 | → |
| 18: | 10.0 | ↗ |
| 19: | 10.3 | ↘ |
| 20: | 10.8x | ↑ |
| Serie | | 99.0 |
| Total | | 199.0 |

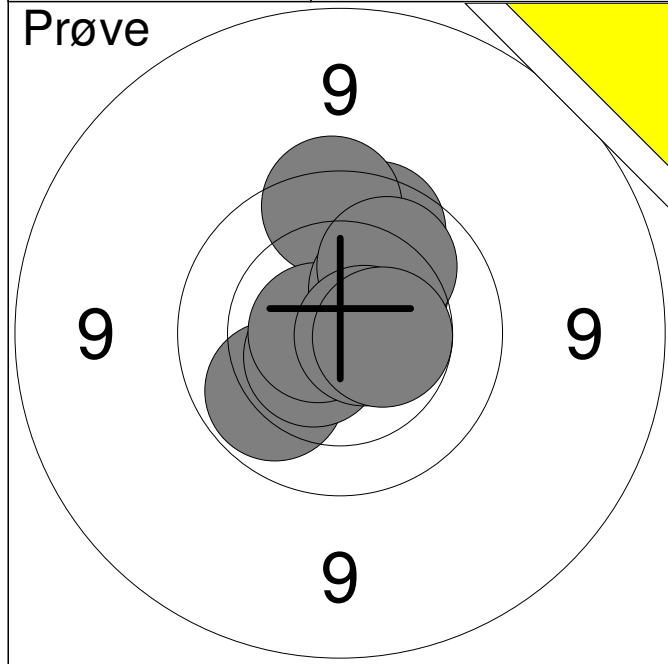

| | | |
|--------------|-------|-------------|
| 1: | 9.9 | ↗ |
| 2: | 9.7 | ↑ |
| 3: | 10.0 | ↙ |
| 4: | 10.6x | ↙ |
| 5: | 10.7x | ← |
| 6: | 10.3 | ↗ |
| 7: | 10.1 | ↗ |
| 8: | 10.7x | → |
| 9: | 10.5 | → |
| Serie | | 88.0 |
| Total | | 0.0 |

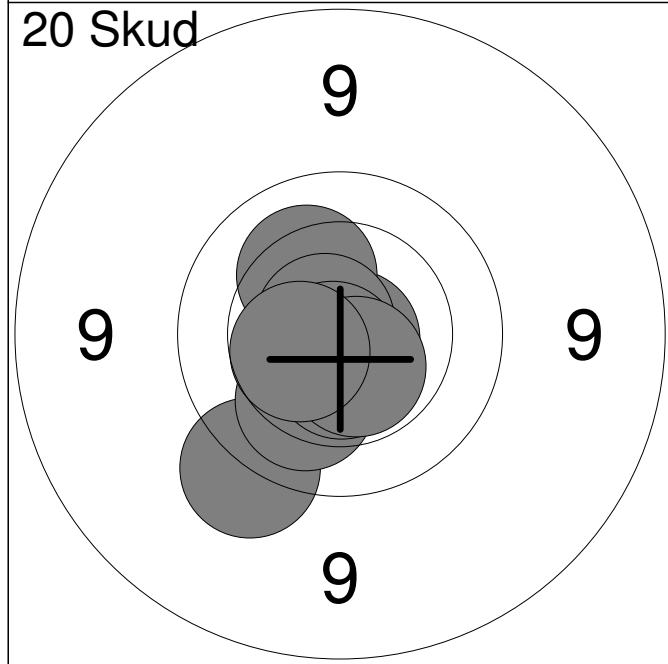

| | | |
|--------------|-------|-------------|
| 1: | 9.5 | ↙ |
| 2: | 10.8x | ↘ |
| 3: | 10.5x | ↙ |
| 4: | 10.2 | ↗ |
| 5: | 10.1 | ↙ |
| 6: | 10.7x | ↗ |
| 7: | 10.6x | ↙ |
| 8: | 10.7x | ↙ |
| 9: | 10.6x | ↙ |
| 10: | 10.5 | ↙ |
| Serie | | 99.0 |
| Total | | 99.0 |

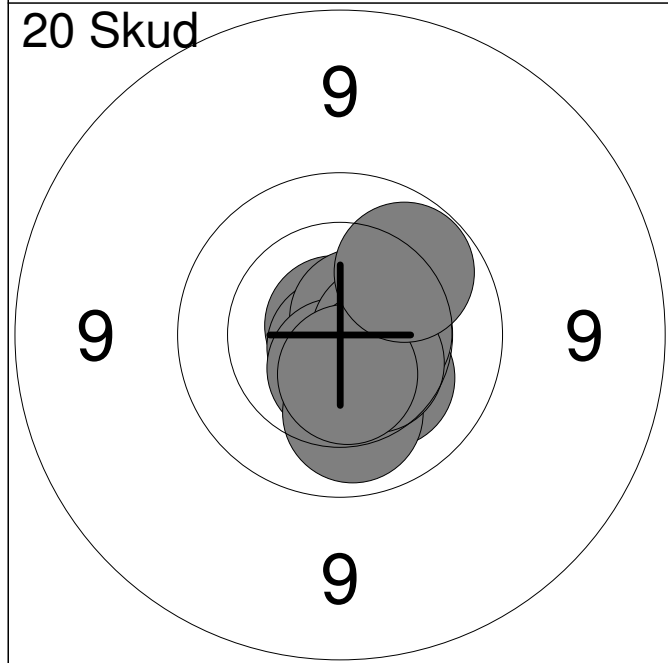

| | | |
|--------------|-------|--------------|
| 11: | 10.8x | ↗ |
| 12: | 10.8x | ↙ |
| 13: | 10.7x | ↗ |
| 14: | 10.6x | ↙ |
| 15: | 10.3 | ↙ |
| 16: | 10.1 | ↙ |
| 17: | 10.5x | → |
| 18: | 10.5 | ↙ |
| 19: | 10.5x | ↙ |
| 20: | 10.0 | ↗ |
| Serie | | 100.0 |
| Total | | 199.0 |

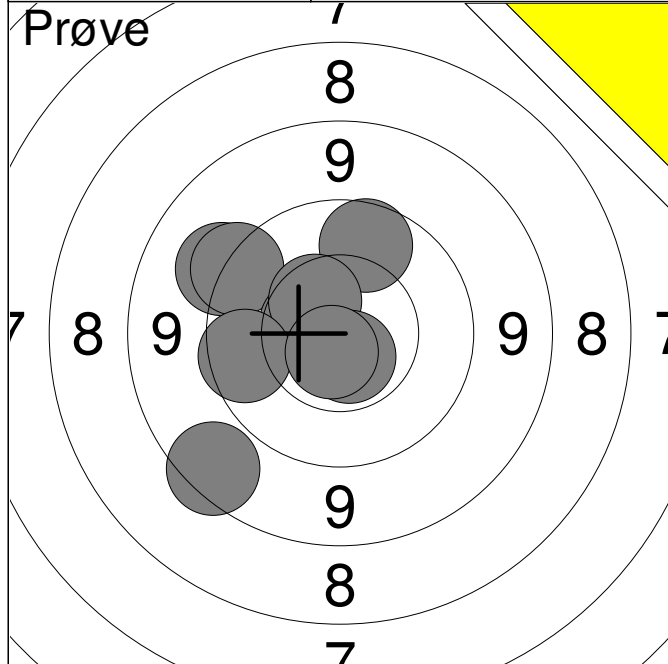

| | | |
|----|-------|---|
| 1: | 9.3 | ↗ |
| 2: | 9.5 | ↗ |
| 3: | 8.7 | ↘ |
| 4: | 9.9 | ↗ |
| 5: | 10.5 | ↗ |
| 6: | 10.5 | ↗ |
| 7: | 9.8 | ↖ |
| 8: | 10.7x | ↘ |
| 9: | 10.7x | ↘ |

| | |
|-------|------|
| Serie | 84.0 |
|-------|------|

| | |
|-------|-----|
| Total | 0.0 |
|-------|-----|

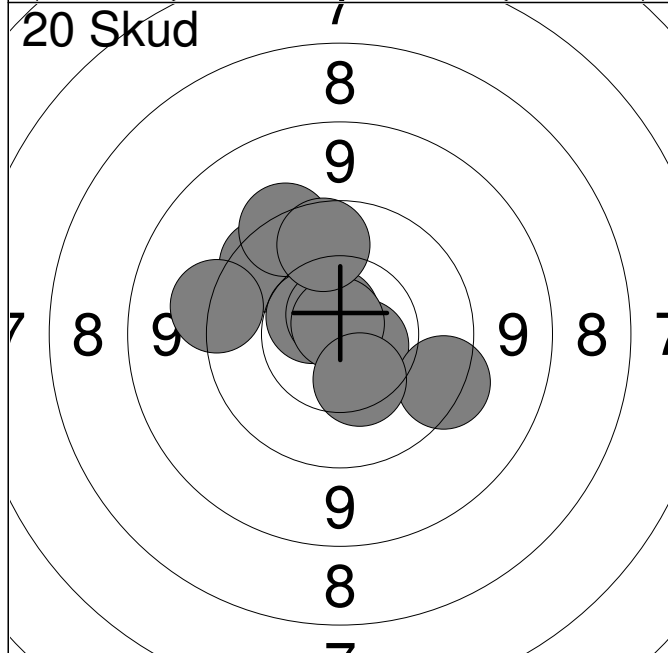

| | | |
|-----|-------|---|
| 1: | 9.8 | ↗ |
| 2: | 9.6 | ↗ |
| 3: | 10.7x | ↘ |
| 4: | 9.6 | ↘ |
| 5: | 10.6 | ↗ |
| 6: | 10.7x | ↗ |
| 7: | 10.8x | ↗ |
| 8: | 9.9 | ↗ |
| 9: | 10.4 | ↘ |
| 10: | 9.4 | ↖ |

| | |
|-------|------|
| Serie | 95.0 |
|-------|------|

| | |
|-------|------|
| Total | 95.0 |
|-------|------|

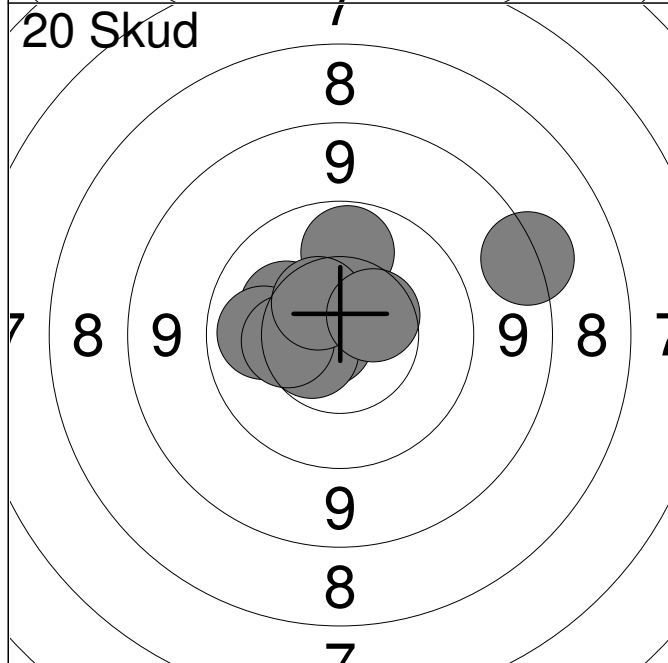

| | | |
|-----|-------|---|
| 11: | 10.3 | ↗ |
| 12: | 10.6x | ↗ |
| 13: | 10.8x | ↖ |
| 14: | 10.1 | ↖ |
| 15: | 10.6 | ↖ |
| 16: | 10.3 | ↖ |
| 17: | 10.0 | ↗ |
| 18: | 8.5 | → |
| 19: | 10.5 | ↗ |
| 20: | 10.5 | ↗ |

| | |
|-------|------|
| Serie | 98.0 |
|-------|------|

| | |
|-------|-------|
| Total | 193.0 |
|-------|-------|

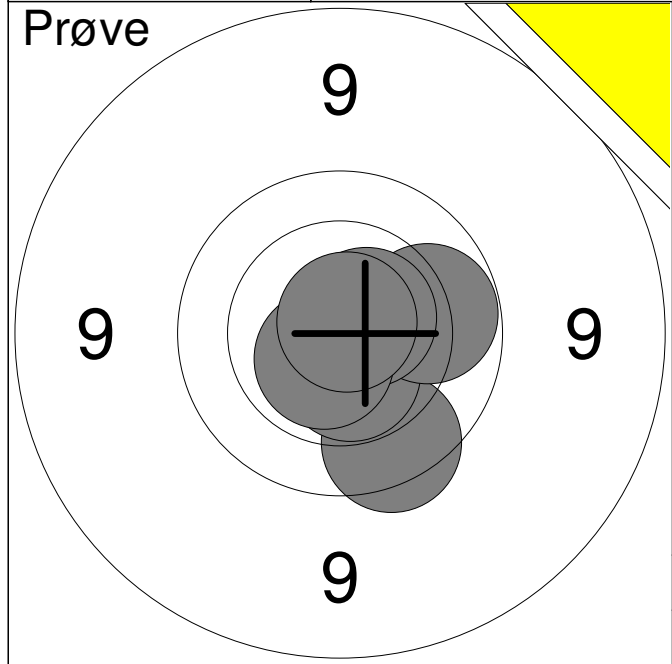

| | | |
|--------------|-------|-------------|
| 1: | 9.8 | ↓ |
| 2: | 10.5x | ↓ |
| 3: | 10.0 | → |
| 4: | 10.6x | → |
| 5: | 10.6x | ↓ |
| 6: | 10.8x | ↗ |
| Serie | | 59.0 |
| Total | | 0.0 |

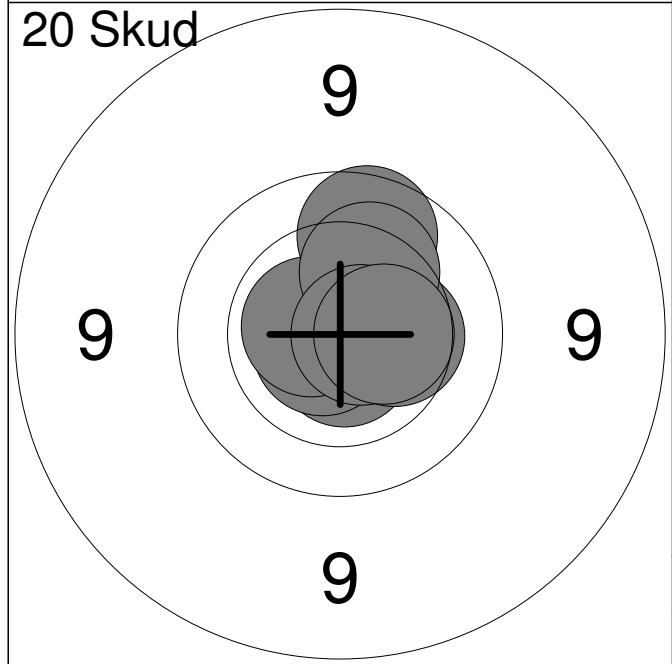

| | | |
|--------------|-------|-------------|
| 1: | 10.5x | ↗ |
| 2: | 10.7x | ↓ |
| 3: | 10.7x | ↙ |
| 4: | 10.6x | ← |
| 5: | 9.9 | ↑ |
| 6: | 10.5x | → |
| 7: | 10.4 | → |
| 8: | 10.2 | ↑ |
| 9: | 10.7x | → |
| 10: | 10.5 | → |
| Serie | | 99.0 |
| Total | | 99.0 |

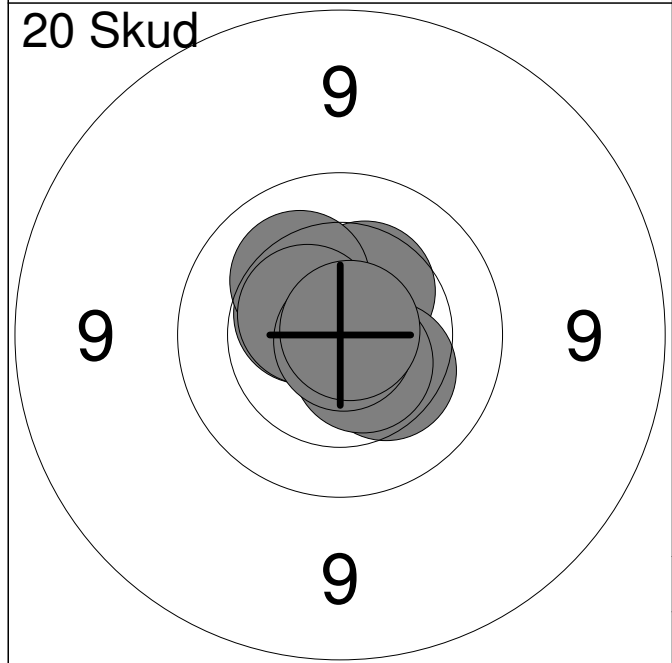

| | | |
|--------------|-------|--------------|
| 11: | 10.8x | → |
| 12: | 10.5x | ↗ |
| 13: | 10.4 | ↗ |
| 14: | 10.3 | ↓ |
| 15: | 10.5 | ↗ |
| 16: | 10.2 | ↗ |
| 17: | 10.6x | ↓ |
| 18: | 10.5x | ↗ |
| 19: | 10.9x | ↓ |
| 20: | 10.8x | → |
| Serie | | 100.0 |
| Total | | 199.0 |

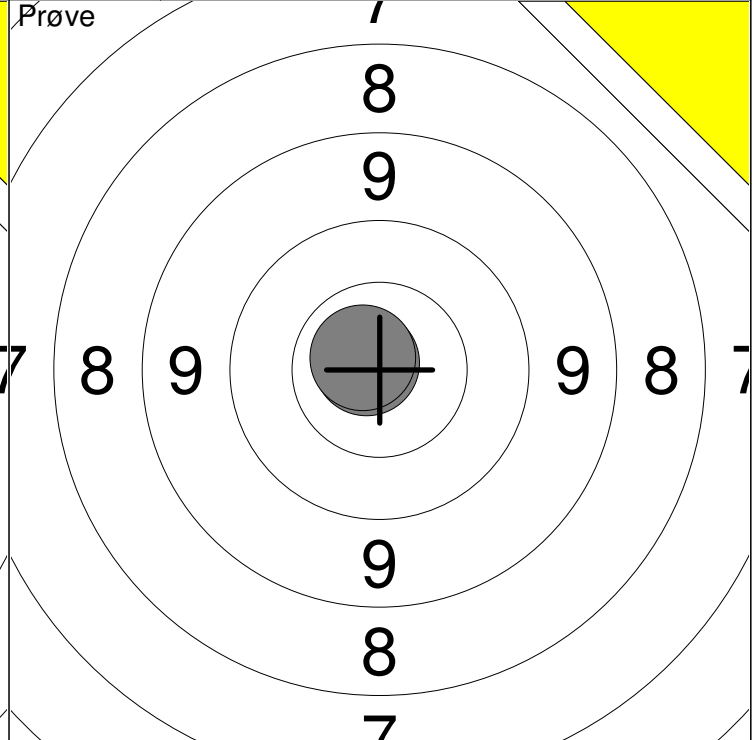
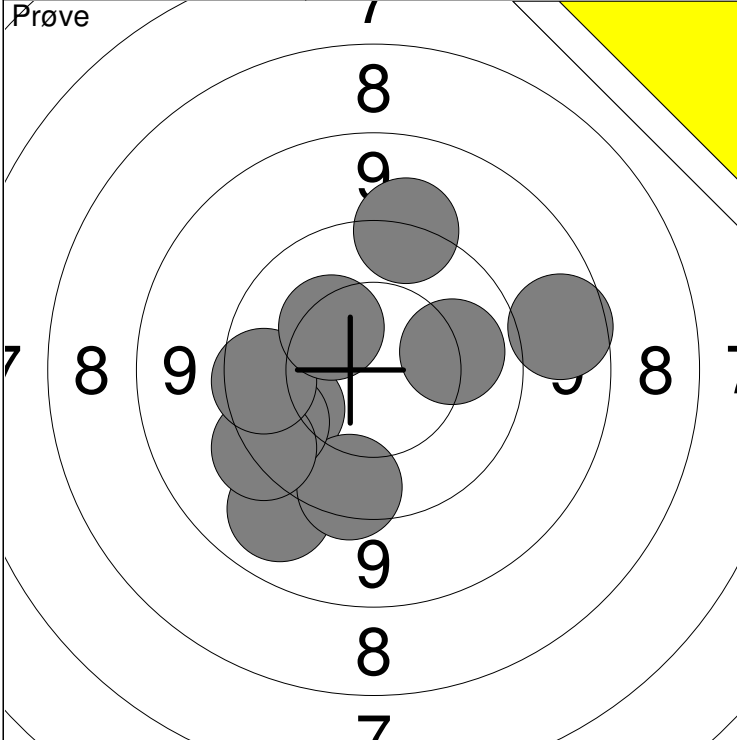

| | | | |
|-----------|------------|-------|----|
| 1: 9.1 ↘ | 6: 8.9 → | Serie | 92 |
| 2: 10.0 ↙ | 7: 10.1 → | | |
| 3: 9.7 ↓ | 8: 9.4 ↑ | Total | 0 |
| 4: 9.8 ↙ | 9: 9.8 ← | | |
| 5: 9.5 ↙ | 10: 10.3 ↖ | | |

| | | |
|-------------|-------|----|
| 11: 10.8x ↖ | Serie | 20 |
| 12: 10.7x ↖ | | |
| Total | | 0 |

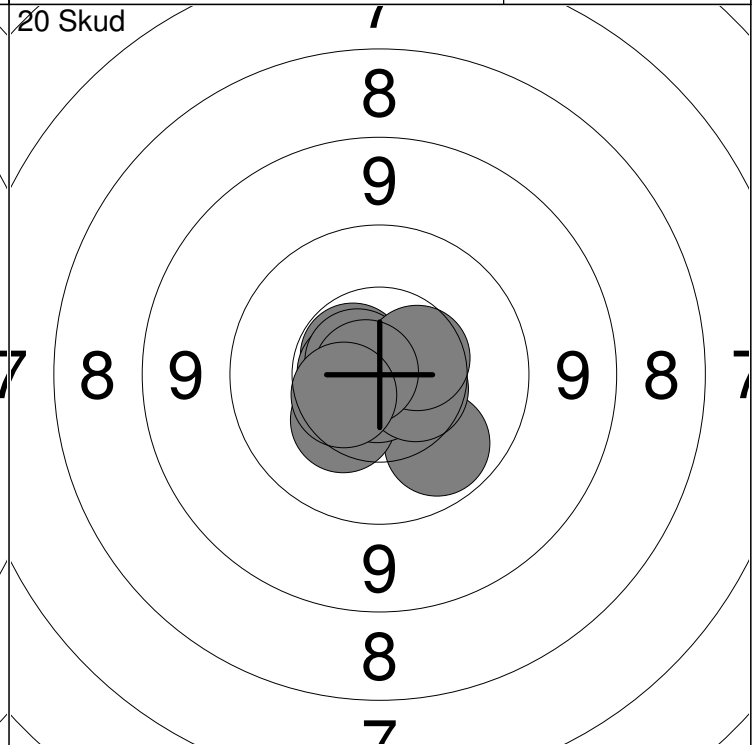
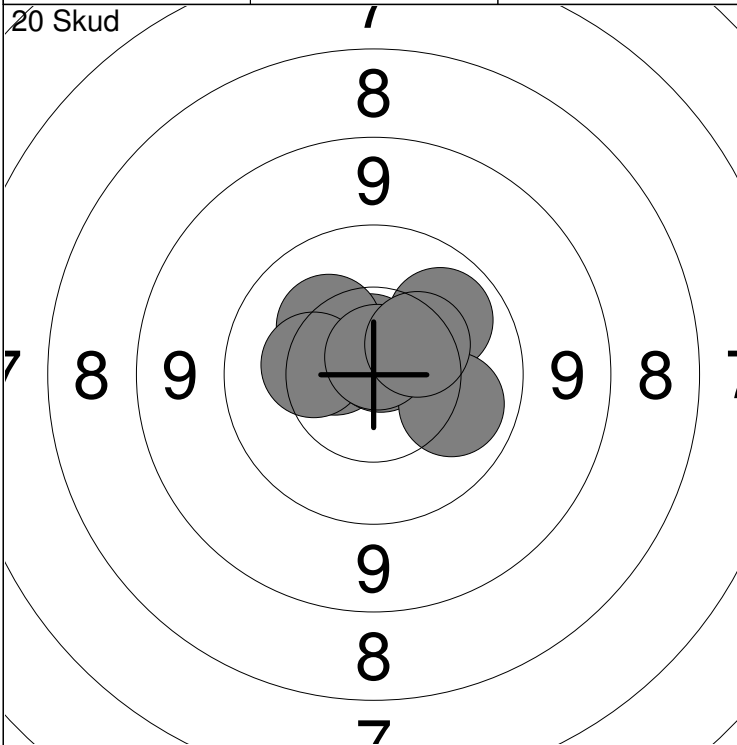

| | | | |
|------------|------------|-------|-----|
| 1: 10.7x ↑ | 6: 10.3 ← | Serie | 100 |
| 2: 10.6 ↗ | 7: 10.8x ↗ | | |
| 3: 10.5 ↙ | 8: 10.1 → | Total | 100 |
| 4: 10.1 ↗ | 9: 10.8x ↑ | | |
| 5: 10.3 ↖ | 10: 10.4 ↗ | | |

| | | | |
|-------------|-------------|-------|-----|
| 11: 10.6x ↖ | 16: 10.8x ↓ | Serie | 100 |
| 12: 10.6x ← | 17: 10.5 → | | |
| 13: 10.0 ↘ | 18: 10.5 ↗ | Total | 200 |
| 14: 10.3 ↙ | 19: 10.8x ← | | |
| 15: 10.7x ↖ | 20: 10.5 ↙ | | |

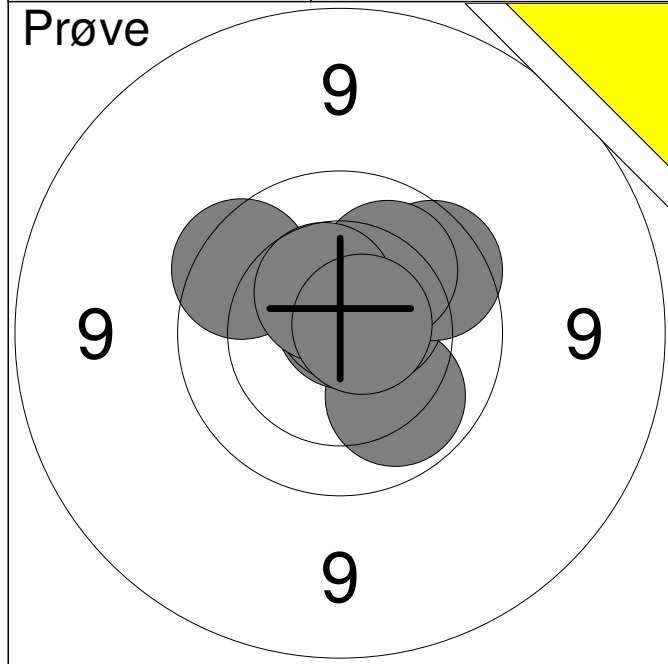

| | | |
|----|-------|---|
| 1: | 10.0 | ↘ |
| 2: | 9.8 | ↗ |
| 3: | 10.5x | → |
| 4: | 9.8 | ↗ |
| 5: | 10.8x | ↑ |
| 6: | 10.7x | ↑ |
| 7: | 10.1 | ↗ |
| 8: | 10.5 | ↑ |
| 9: | 10.7x | → |

| | |
|--------------|-------------|
| Serie | 88.0 |
| Total | 0.0 |

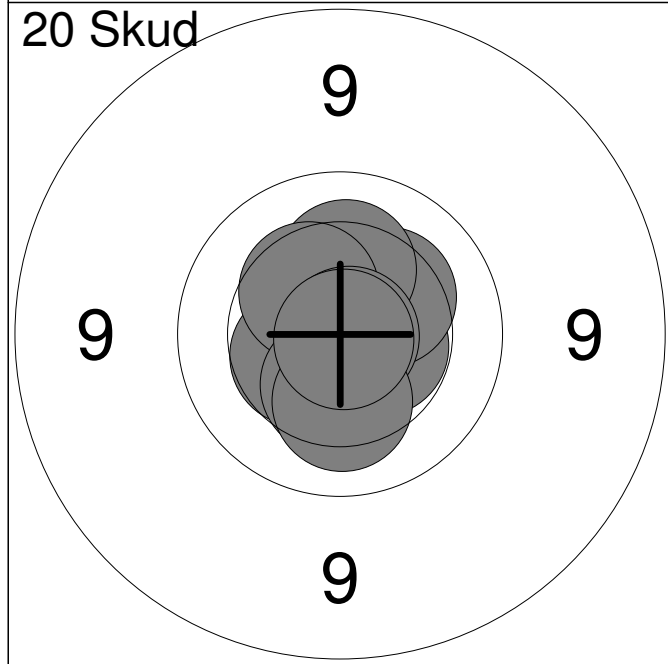

| | | |
|-----|-------|---|
| 1: | 10.5x | → |
| 2: | 10.6x | ← |
| 3: | 10.5 | ← |
| 4: | 10.3 | ↗ |
| 5: | 10.3 | ↑ |
| 6: | 10.4 | ↗ |
| 7: | 10.9x | → |
| 8: | 10.4 | ↓ |
| 9: | 10.2 | ↓ |
| 10: | 10.9x | ↓ |

| | |
|--------------|--------------|
| Serie | 100.0 |
| Total | 100.0 |

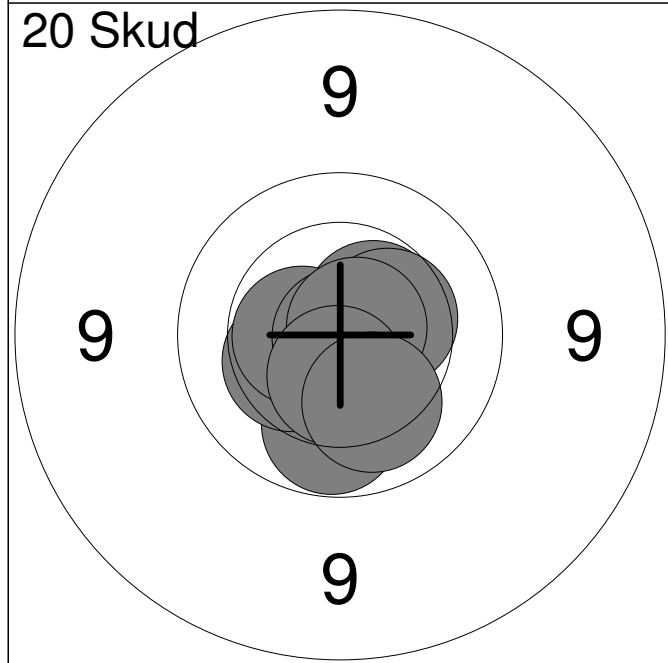

| | | |
|-----|-------|---|
| 11: | 10.5x | ↗ |
| 12: | 10.0 | ↓ |
| 13: | 10.4 | ← |
| 14: | 10.6x | → |
| 15: | 10.5x | ← |
| 16: | 10.4 | ↗ |
| 17: | 10.9x | ↘ |
| 18: | 10.8x | ↗ |
| 19: | 10.5x | ↓ |
| 20: | 10.1 | ↓ |

| | |
|--------------|--------------|
| Serie | 100.0 |
| Total | 200.0 |

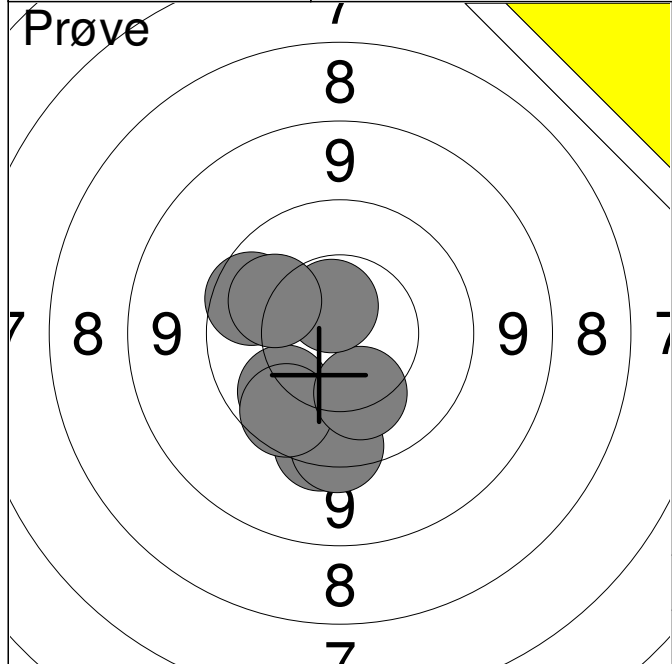

| | | |
|--------------|-------|-------------|
| 1: | 9.6 | ↓ |
| 2: | 9.8 | ↓ |
| 3: | 9.6 | ↓ |
| 4: | 10.0 | ↙ |
| 5: | 9.9 | ↙ |
| 6: | 10.2 | ↓ |
| 7: | 9.8 | ↗ |
| 8: | 10.6x | ↑ |
| 9: | 10.1 | ↗ |
| Serie | | 85.0 |
| Total | | 0.0 |

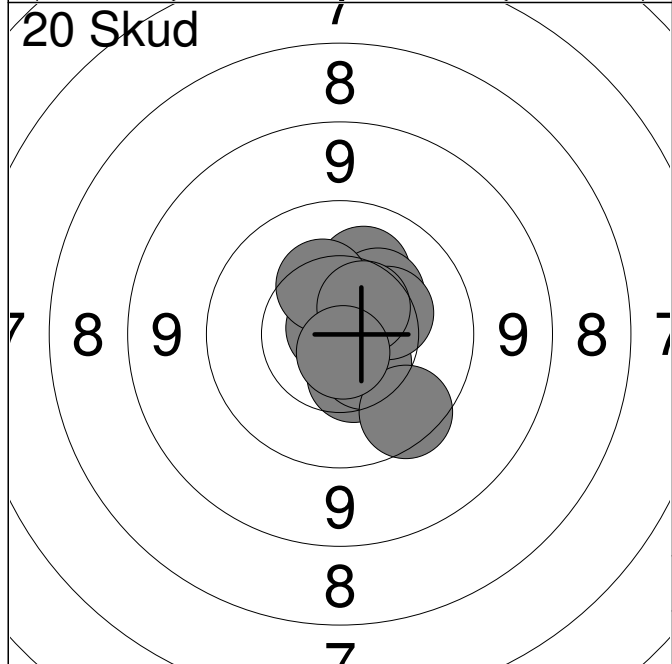

| | | |
|--------------|-------|-------------|
| 1: | 10.2 | ↑ |
| 2: | 10.8x | ↗ |
| 3: | 10.4 | ↓ |
| 4: | 10.5 | ↓ |
| 5: | 10.3 | ↗ |
| 6: | 9.8 | ↓ |
| 7: | 10.4 | ↗ |
| 8: | 10.4 | ↑ |
| 9: | 10.5 | ↗ |
| 10: | 10.7x | ↓ |
| Serie | | 99.0 |
| Total | | 99.0 |

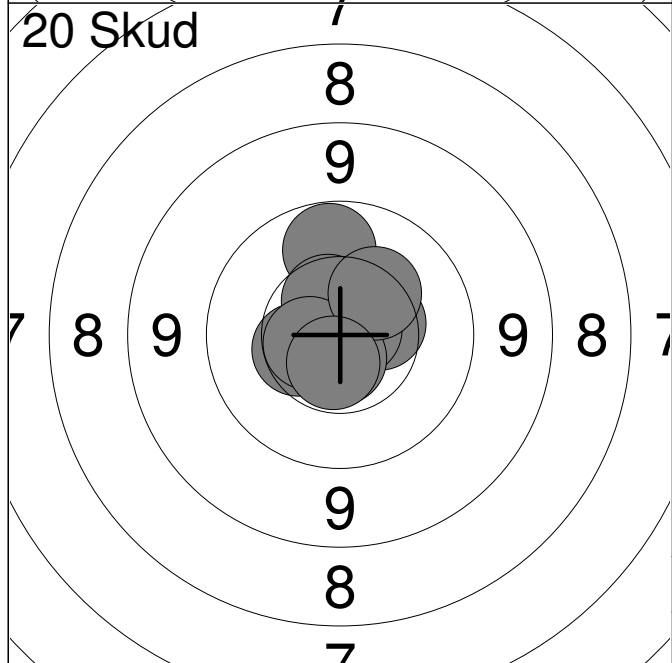

| | | |
|--------------|-------|--------------|
| 11: | 10.4 | ↑ |
| 12: | 10.5 | → |
| 13: | 10.4 | ← |
| 14: | 10.0 | ↑ |
| 15: | 10.8x | ↗ |
| 16: | 10.5 | ↑ |
| 17: | 10.7x | ↓ |
| 18: | 10.6x | ← |
| 19: | 10.3 | ↗ |
| 20: | 10.6x | ↓ |
| Serie | | 100.0 |
| Total | | 199.0 |

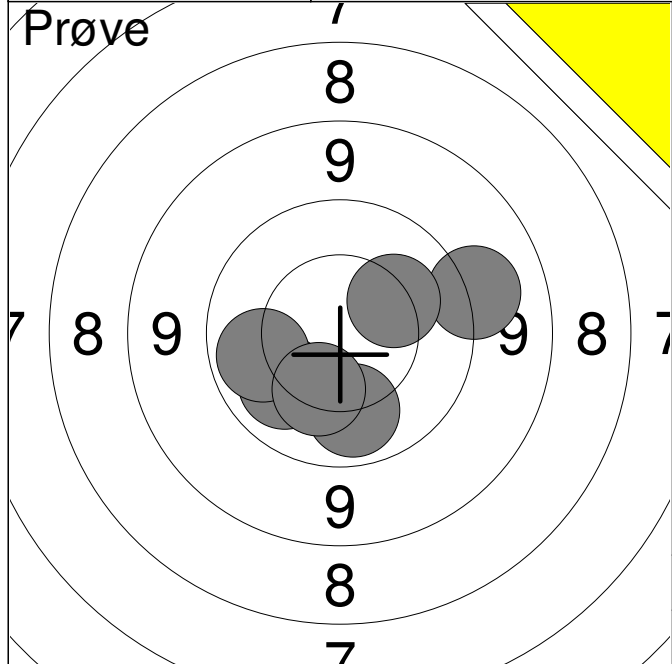

| | | |
|--------------|------|-------------|
| 1: | 10.1 | ↙ |
| 2: | 10.0 | ↓ |
| 3: | 10.0 | ↙ |
| 4: | 9.3 | → |
| 5: | 10.3 | ↓ |
| 6: | 10.2 | ↗ |
| Serie | | 59.0 |
| Total | | 0.0 |

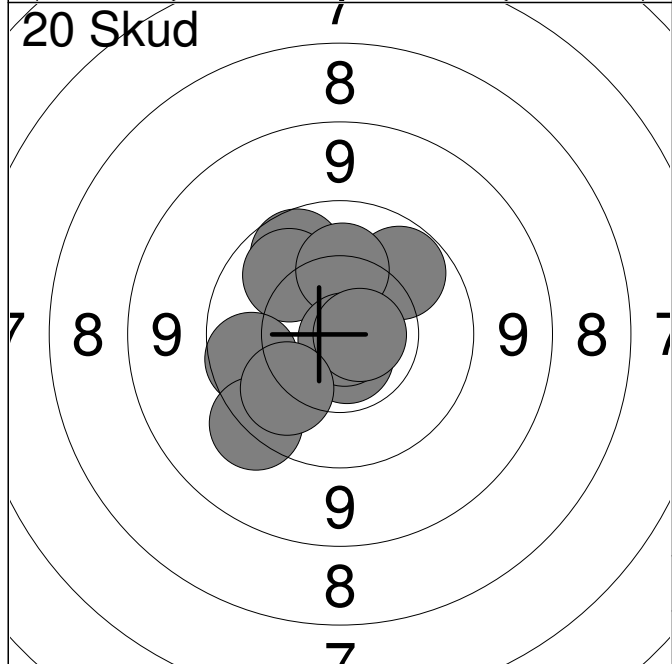

| | | |
|--------------|-------|-------------|
| 1: | 10.0 | ↗ |
| 2: | 9.9 | ↗ |
| 3: | 10.0 | ↗ |
| 4: | 10.2 | ↑ |
| 5: | 10.7x | ↓ |
| 6: | 10.9x | ↓ |
| 7: | 9.9 | ↙ |
| 8: | 10.7x | → |
| 9: | 9.5 | ↙ |
| 10: | 10.1 | ↙ |
| Serie | | 97.0 |
| Total | | 97.0 |

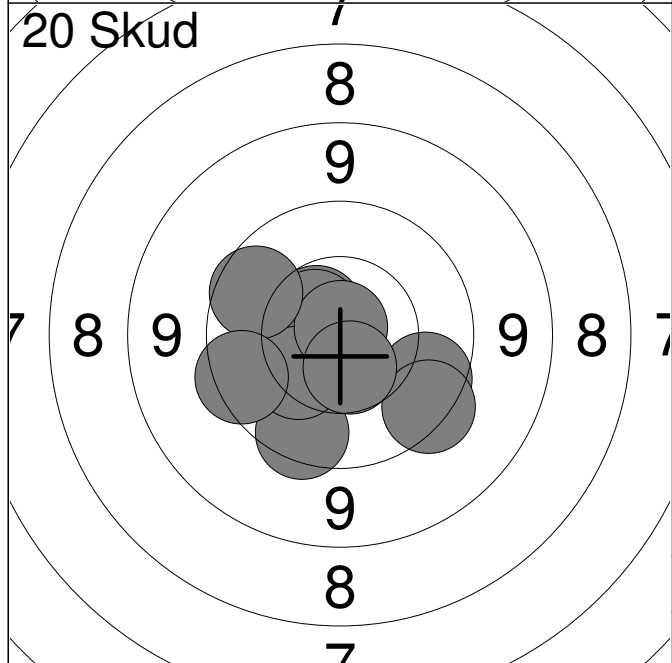

| | | |
|--------------|-------|--------------|
| 11: | 9.8 | ↘ |
| 12: | 9.7 | ↙ |
| 13: | 10.6 | ↗ |
| 14: | 10.6 | ↗ |
| 15: | 10.3 | ↙ |
| 16: | 10.9x | ↑ |
| 17: | 9.9 | ↗ |
| 18: | 9.6 | ↘ |
| 19: | 10.6 | ↘ |
| 20: | 9.7 | ↙ |
| Serie | | 95.0 |
| Total | | 192.0 |

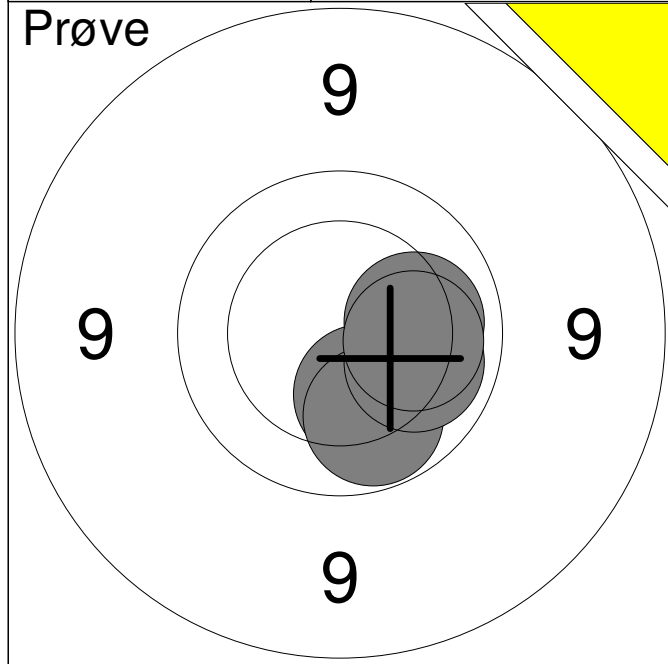

| | | |
|--------------|------|-------------|
| 1: | 10.2 | ↘ |
| 2: | 10.0 | ↘ |
| 3: | 10.1 | → |
| 4: | 10.1 | ↘ |
| 5: | 10.2 | → |
| Serie | | 50.0 |
| Total | | 0.0 |

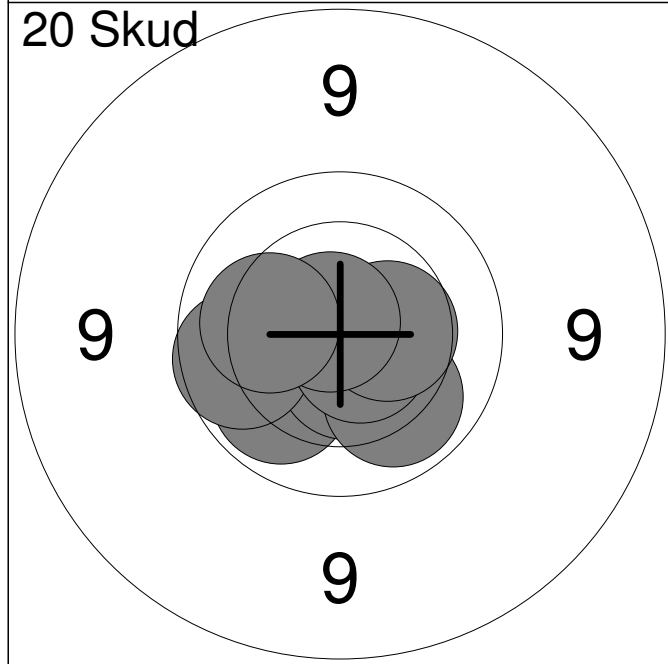

| | | |
|--------------|-------|-------------|
| 1: | 10.0 | ↙ |
| 2: | 10.6x | ↘ |
| 3: | 10.6x | → |
| 4: | 9.9 | ← |
| 5: | 10.1 | ↘ |
| 6: | 10.9x | → |
| 7: | 10.7x | ↘ |
| 8: | 10.4 | → |
| 9: | 10.8x | ↗ |
| 10: | 10.2 | ← |
| Serie | | 99.0 |
| Total | | 99.0 |

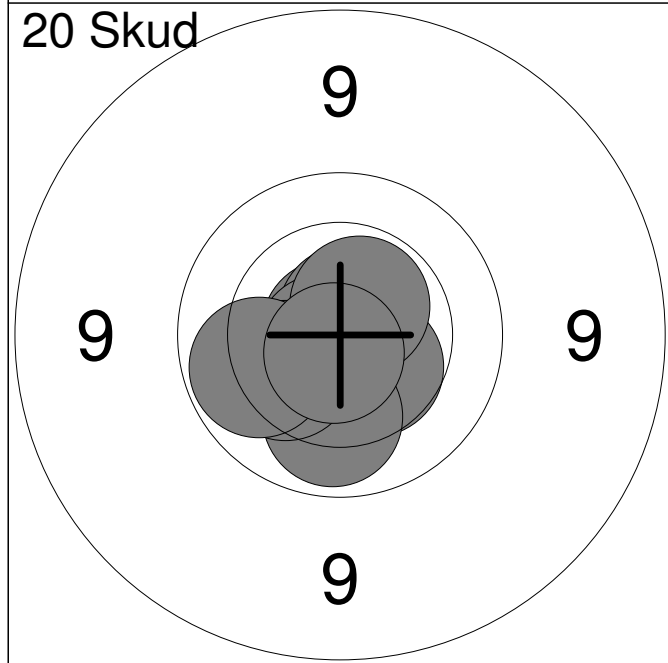

| | | |
|--------------|-------|--------------|
| 11: | 10.5 | ↘ |
| 12: | 10.4 | ↙ |
| 13: | 10.8x | ↗ |
| 14: | 10.7x | ↗ |
| 15: | 10.8x | ↙ |
| 16: | 10.1 | ↘ |
| 17: | 10.2 | ↙ |
| 18: | 10.6x | ↗ |
| 19: | 10.0 | ↙ |
| 20: | 10.7x | ↘ |
| Serie | | 100.0 |
| Total | | 199.0 |

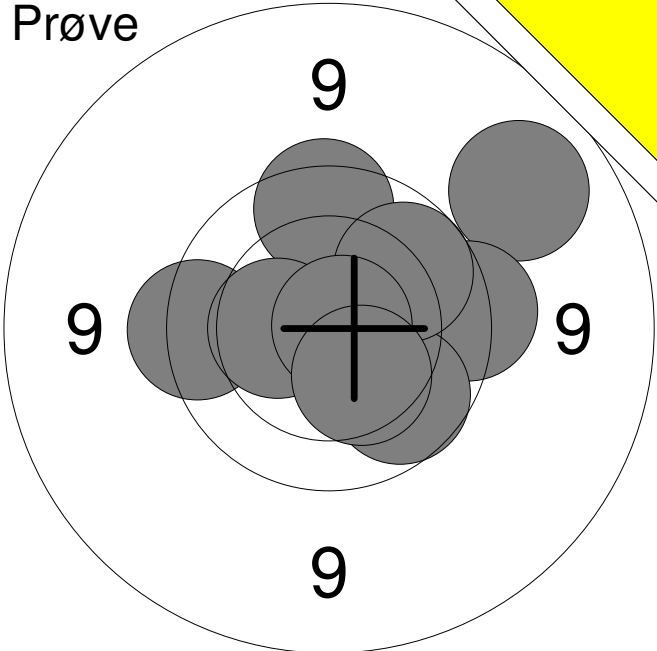
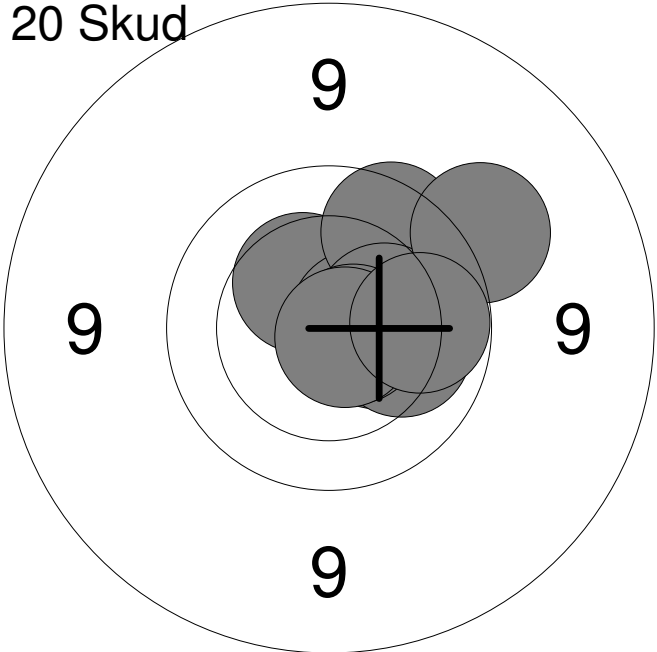
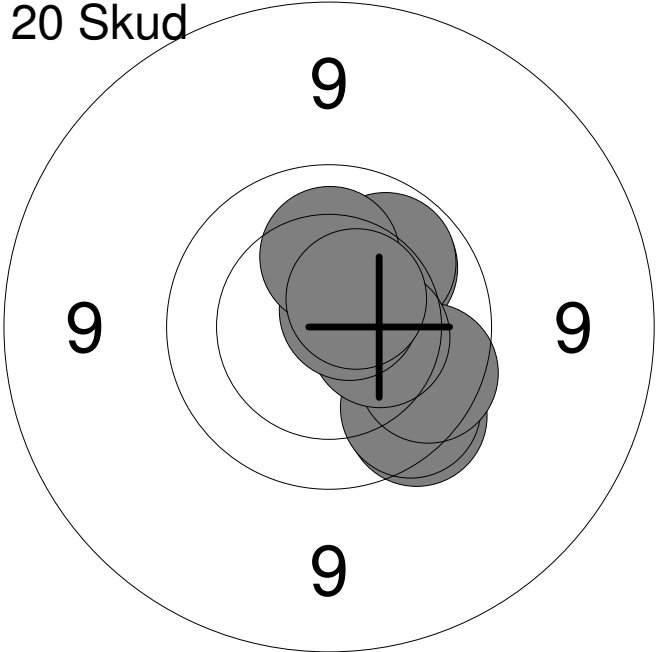
| Hold | Skive | Louise Pedersen | |
|--|---------------------------------|---------------------|-------------|
| 30 | 2 | | |
| 15m | Vester Hassing Skf. | ÅK2 | |
| | 15 meter riffelstævne oktober 2 | Aalborg Skyttekreds | |
| Prøve  | 1: | 9.8 | ↑ |
| | 2: | 9.1 | ↗ |
| | 3: | 10.3 | → |
| | 4: | 9.7 | → |
| | 5: | 9.7 | ← |
| | 6: | 9.9 | ↘ |
| | 7: | 10.4 | ← |
| | 8: | 9.9 | ↗ |
| | 9: | 10.8x | → |
| | 10: | 10.3 | ↘ |
| | Serie | | 94.0 |
| Total | | 0.0 | |
| 20 Skud  | 1: | 10.4 | → |
| | 2: | 10.4 | ↗ |
| | 3: | 10.6x | → |
| | 4: | 9.8 | ↗ |
| | 5: | 10.3 | → |
| | 6: | 10.1 | → |
| | 7: | 10.7x | → |
| | 8: | 9.4 | ↗ |
| | 9: | 10.8x | ↘ |
| | 10: | 10.0 | → |
| | Serie | | 98.0 |
| Total | | 98.0 | |
| 20 Skud  | 11: | 9.7 | ↘ |
| | 12: | 9.8 | ↘ |
| | 13: | 10.1 | ↗ |
| | 14: | 10.5x | ↗ |
| | 15: | 10.0 | ↗ |
| | 16: | 9.8 | ↘ |
| | 17: | 10.4 | → |
| | 18: | 10.7x | ↗ |
| | 19: | 10.2 | ↑ |
| | 20: | 10.5x | ↗ |
| | Serie | | 97.0 |
| Total | | 195.0 | |

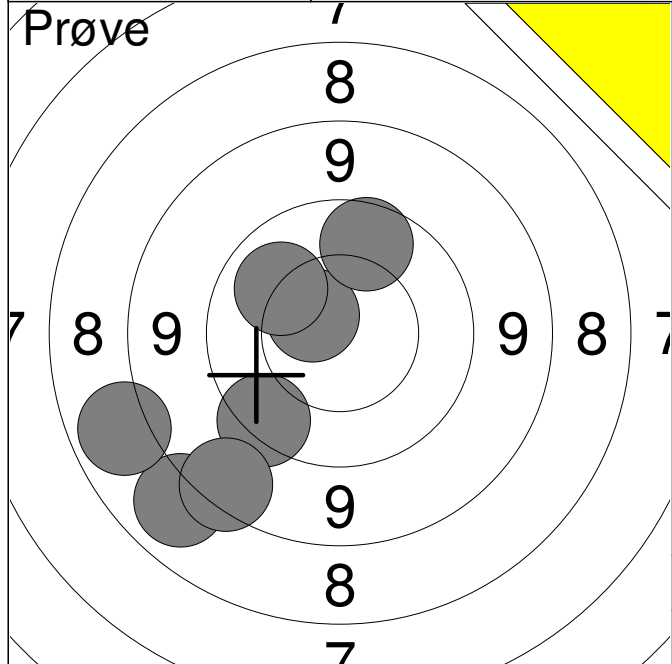

| | | |
|--------------|------|-------------|
| 1: | 10.6 | ↗ |
| 2: | 9.6 | ↘ |
| 3: | 8.1 | ↘ |
| 4: | 8.0 | ↙ |
| 5: | 8.6 | ↘ |
| 6: | 9.9 | ↗ |
| 7: | 10.1 | ↗ |
| Serie | | 62.0 |
| Total | | 0.0 |

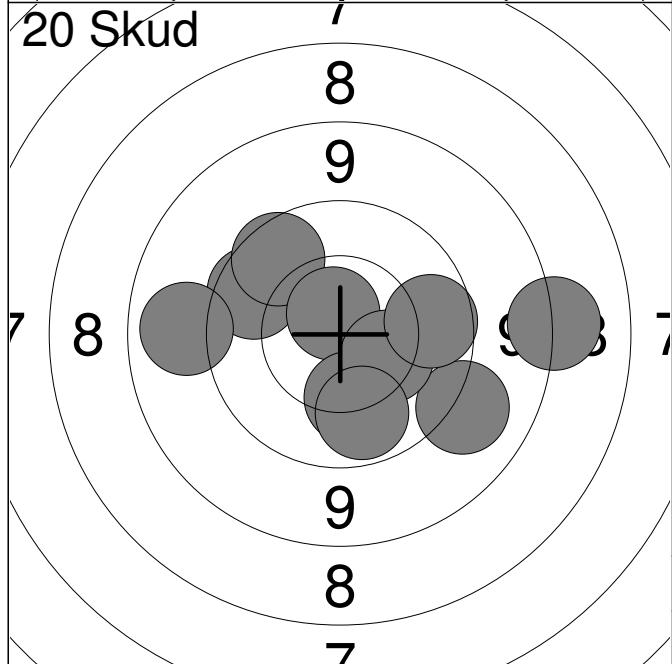

| | | |
|--------------|-------|-------------|
| 1: | 9.8 | ↗ |
| 2: | 9.8 | ↗ |
| 3: | 10.7x | ↗ |
| 4: | 9.1 | ↙ |
| 5: | 9.2 | ↘ |
| 6: | 8.3 | → |
| 7: | 10.2 | ↘ |
| 8: | 10.3 | ↘ |
| 9: | 10.0 | ↘ |
| 10: | 9.9 | → |
| Serie | | 93.0 |
| Total | | 93.0 |

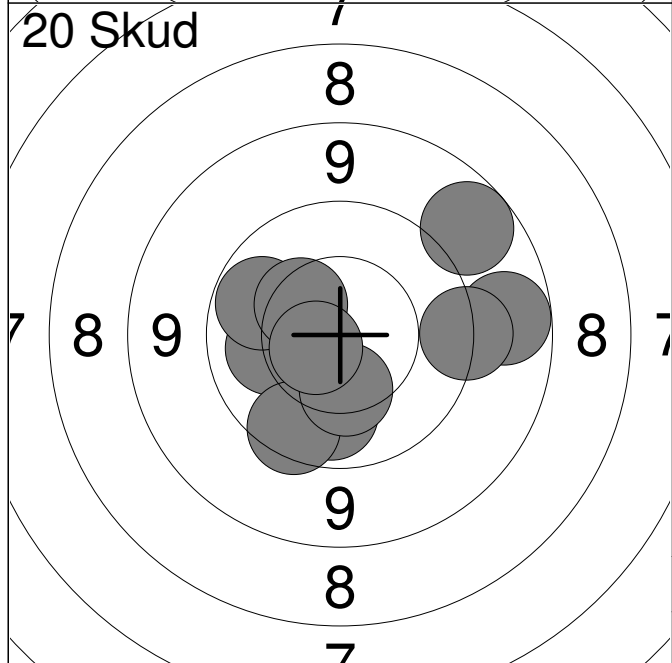

| | | |
|--------------|-------|--------------|
| 11: | 10.0 | ↓ |
| 12: | 10.1 | ↙ |
| 13: | 9.0 | → |
| 14: | 9.7 | ↘ |
| 15: | 10.3 | ↘ |
| 16: | 9.4 | → |
| 17: | 10.0 | ↗ |
| 18: | 10.4 | ↗ |
| 19: | 10.6x | ↙ |
| 20: | 8.9 | ↗ |
| Serie | | 95.0 |
| Total | | 188.0 |

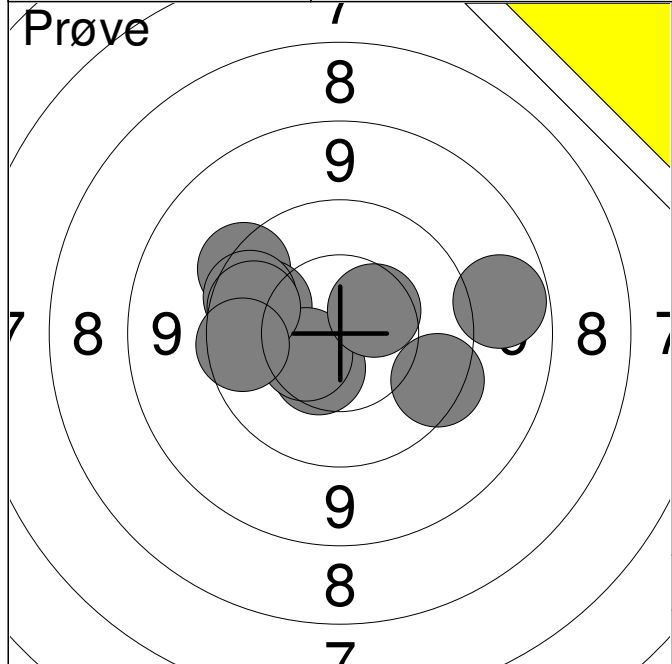

| | | |
|--------------|------|-------------|
| 1: | 9.6 | ↗ |
| 2: | 9.7 | ↘ |
| 3: | 9.0 | → |
| 4: | 10.0 | ↖ |
| 5: | 10.5 | ↙ |
| 6: | 10.5 | ↖ |
| 7: | 9.8 | ↖ |
| 8: | 9.9 | ↖ |
| 9: | 10.5 | ↗ |
| 10: | 9.8 | ← |
| Serie | | 94.0 |
| Total | | 0.0 |

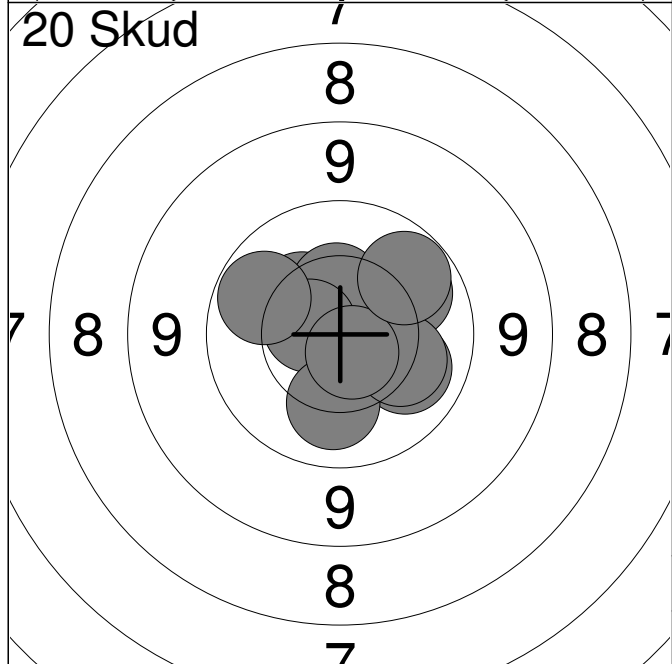

| | | |
|--------------|-------|--------------|
| 1: | 10.1 | ↗ |
| 2: | 10.4 | ↗ |
| 3: | 10.1 | ↘ |
| 4: | 10.4 | ↑ |
| 5: | 10.6x | ↖ |
| 6: | 10.1 | ↙ |
| 7: | 10.0 | ↖ |
| 8: | 10.2 | ↘ |
| 9: | 10.7x | ↙ |
| 10: | 10.0 | ↗ |
| Serie | | 100.0 |
| Total | | 100.0 |

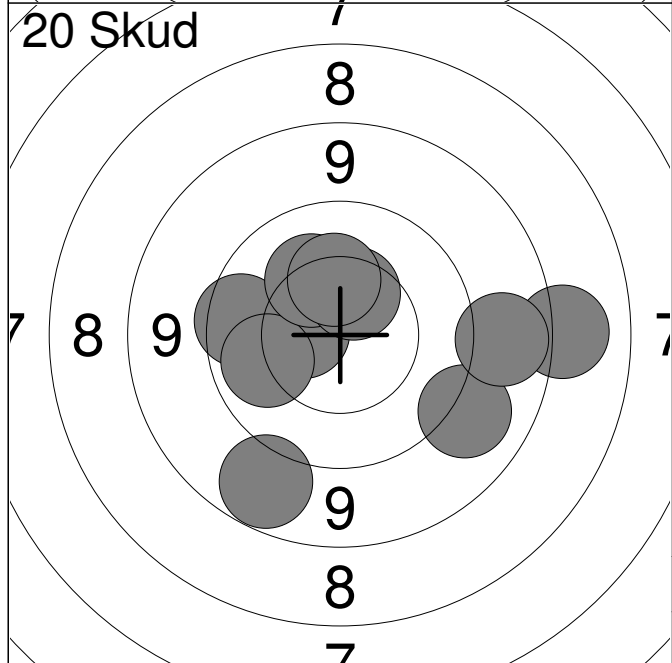

| | | |
|--------------|------|--------------|
| 11: | 10.5 | ← |
| 12: | 9.8 | ← |
| 13: | 10.1 | ← |
| 14: | 8.2 | → |
| 15: | 10.2 | ↗ |
| 16: | 10.4 | ↗ |
| 17: | 10.3 | ↑ |
| 18: | 9.0 | ↙ |
| 19: | 9.2 | ↘ |
| 20: | 9.0 | → |
| Serie | | 94.0 |
| Total | | 194.0 |

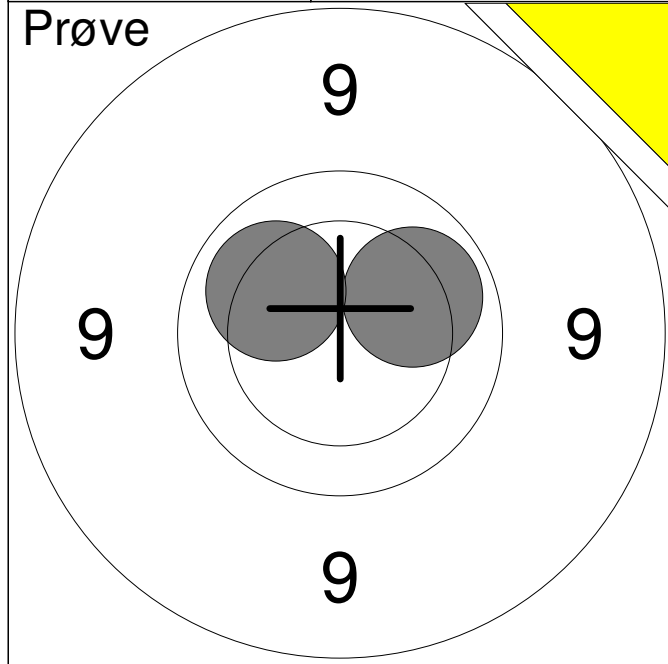

| | | |
|--------------|-------------|---|
| 1: | 10.1 | ↗ |
| 2: | 10.1 | ↖ |
| Serie | 20.0 | |
| Total | 0.0 | |

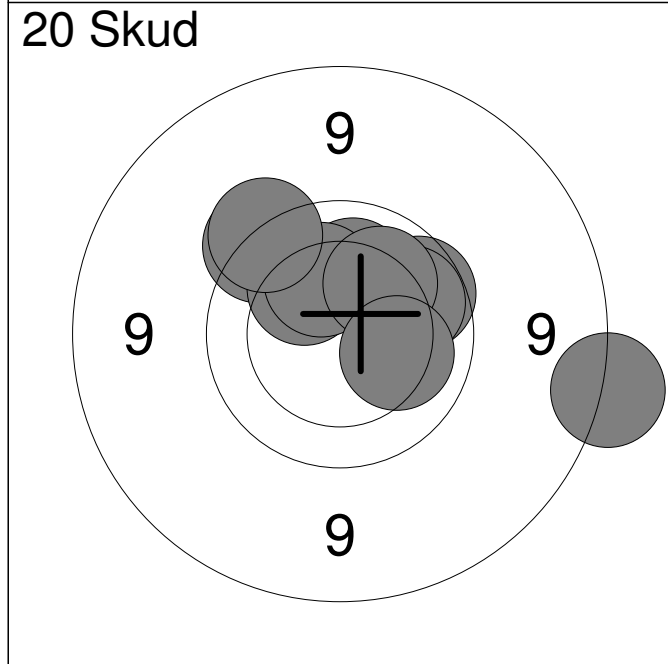

| | | |
|--------------|-------------|---|
| 1: | 9.9 | ↗ |
| 2: | 10.0 | ↗ |
| 3: | 10.2 | ↖ |
| 4: | 9.6 | ↗ |
| 5: | 10.2 | ↗ |
| 6: | 10.2 | ↗ |
| 7: | 8.6 | → |
| 8: | 10.1 | ↗ |
| 9: | 10.2 | → |
| 10: | 9.6 | ↖ |
| Serie | 95.0 | |
| Total | 95.0 | |

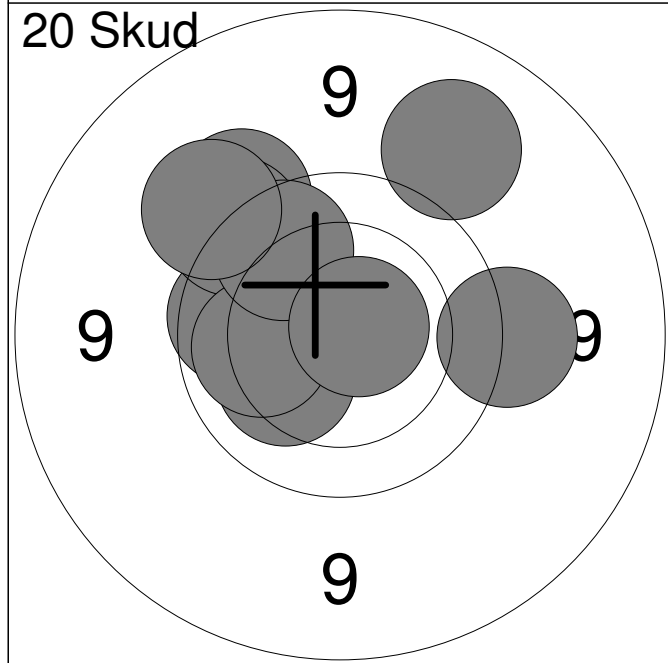

| | | |
|--------------|--------------|---|
| 11: | 9.9 | ← |
| 12: | 10.2 | ↖ |
| 13: | 9.2 | ↗ |
| 14: | 9.5 | ↗ |
| 15: | 9.6 | ↗ |
| 16: | 10.1 | ← |
| 17: | 9.9 | ↗ |
| 18: | 9.5 | → |
| 19: | 10.7x | ↗ |
| 20: | 9.4 | ↖ |
| Serie | 93.0 | |
| Total | 188.0 | |

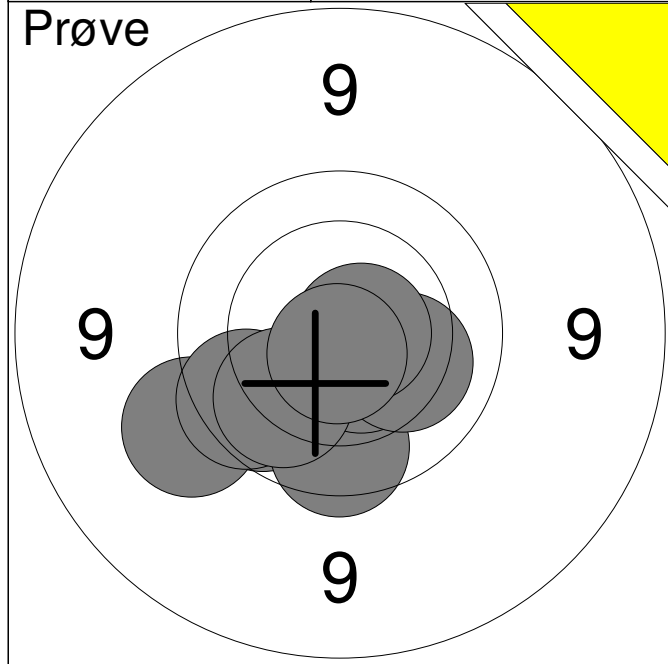

| | | |
|--------------|-------|-------------|
| 1: | 9.9 | ↙ |
| 2: | 9.4 | ↙ |
| 3: | 10.5x | ↓ |
| 4: | 9.8 | ↓ |
| 5: | 10.6x | ↘ |
| 6: | 10.2 | → |
| 7: | 9.8 | ↙ |
| 8: | 10.7x | → |
| 9: | 10.0 | ↙ |
| 10: | 10.7x | ↓ |
| Serie | | 96.0 |
| Total | | 0.0 |

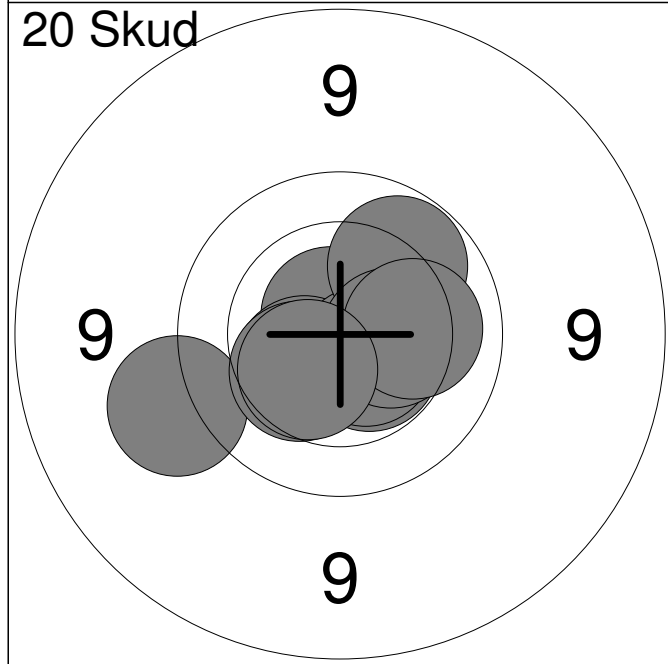

| | | |
|--------------|-------|-------------|
| 1: | 10.7x | ↗ |
| 2: | 10.5x | ↘ |
| 3: | 10.4 | ↙ |
| 4: | 10.6x | ↘ |
| 5: | 9.4 | ↙ |
| 6: | 10.4 | ↙ |
| 7: | 10.0 | ↗ |
| 8: | 10.4 | → |
| 9: | 10.2 | → |
| 10: | 10.4 | ↙ |
| Serie | | 99.0 |
| Total | | 99.0 |

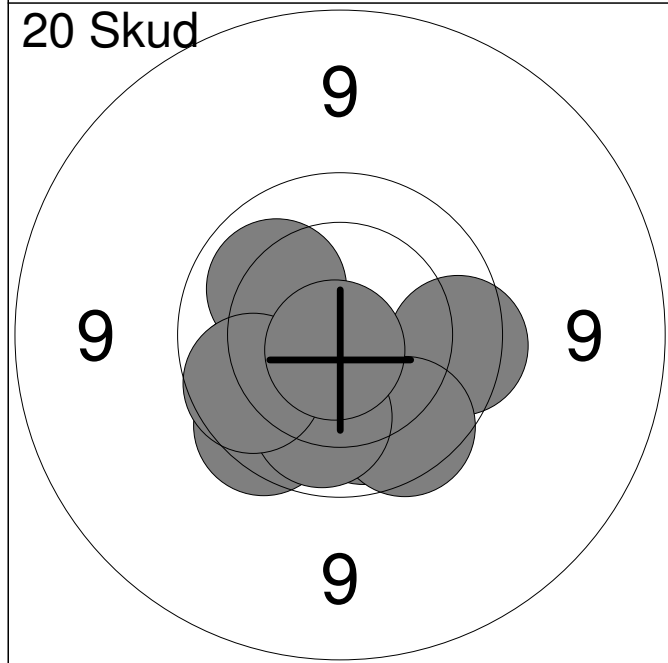

| | | |
|--------------|-------|--------------|
| 11: | 10.1 | ↓ |
| 12: | 10.4 | ↓ |
| 13: | 9.8 | → |
| 14: | 9.8 | ↙ |
| 15: | 10.0 | ↙ |
| 16: | 9.8 | ↘ |
| 17: | 10.0 | ↘ |
| 18: | 10.1 | ↗ |
| 19: | 9.9 | ↙ |
| 20: | 10.8x | ↓ |
| Serie | | 96.0 |
| Total | | 195.0 |

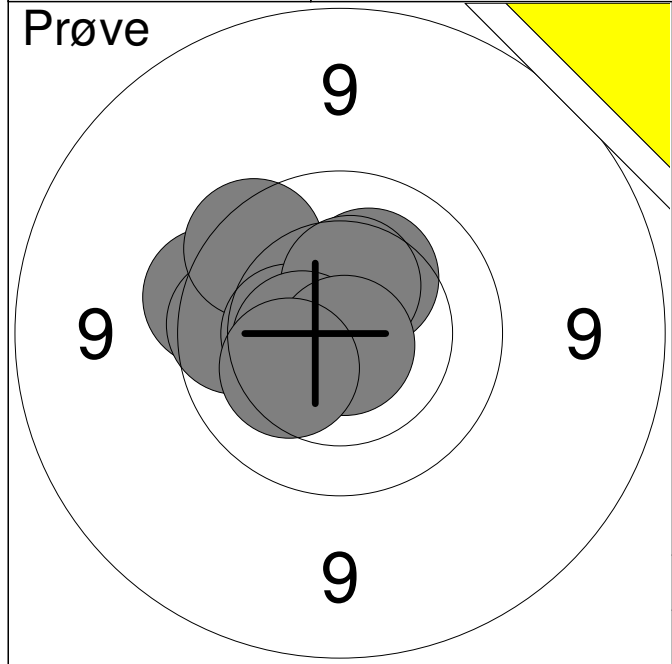

| | | |
|--------------|-------|-------------|
| 1: | 9.7 | ← |
| 2: | 9.9 | ← |
| 3: | 10.3 | ↑ |
| 4: | 10.5 | ↗ |
| 5: | 9.8 | ↗ |
| 6: | 10.4 | ← |
| 7: | 10.4 | ↑ |
| 8: | 10.5x | ← |
| 9: | 10.8x | ↓ |
| 10: | 10.3 | ↙ |
| Serie | | 97.0 |
| Total | | 0.0 |

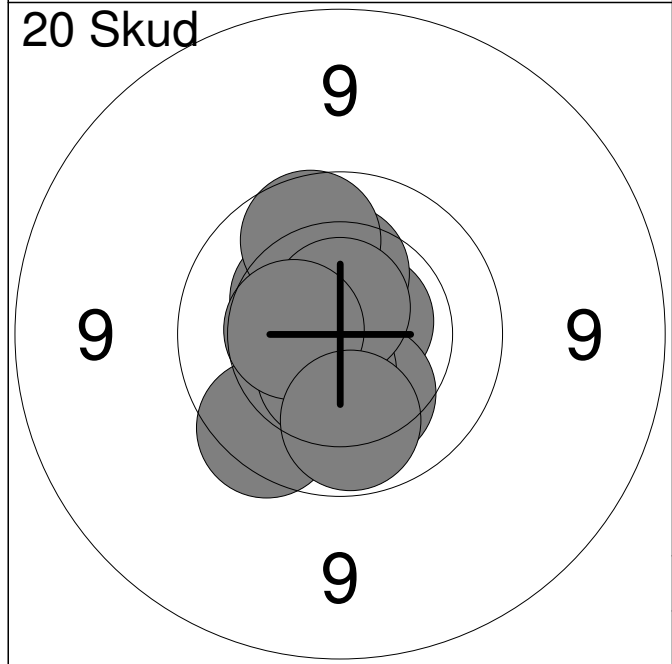

| | | |
|--------------|-------|-------------|
| 1: | 10.4 | ↖ |
| 2: | 9.8 | ↙ |
| 3: | 10.7x | → |
| 4: | 10.3 | ↓ |
| 5: | 10.3 | ↑ |
| 6: | 10.5x | ↙ |
| 7: | 9.9 | ↑ |
| 8: | 10.7x | ↑ |
| 9: | 10.4 | ← |
| 10: | 10.0 | ↓ |
| Serie | | 98.0 |
| Total | | 98.0 |

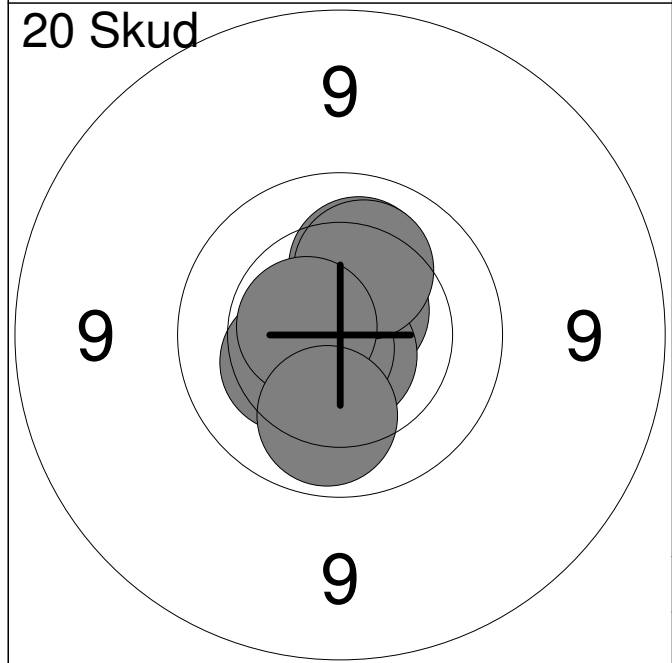

| | | |
|--------------|-------|--------------|
| 11: | 10.9x | ↖ |
| 12: | 10.7x | ↓ |
| 13: | 10.6x | ↗ |
| 14: | 10.2 | ↑ |
| 15: | 10.7x | ↓ |
| 16: | 10.7x | ↙ |
| 17: | 10.2 | ↑ |
| 18: | 10.3 | ← |
| 19: | 10.6x | ← |
| 20: | 10.1 | ↓ |
| Serie | | 100.0 |
| Total | | 198.0 |

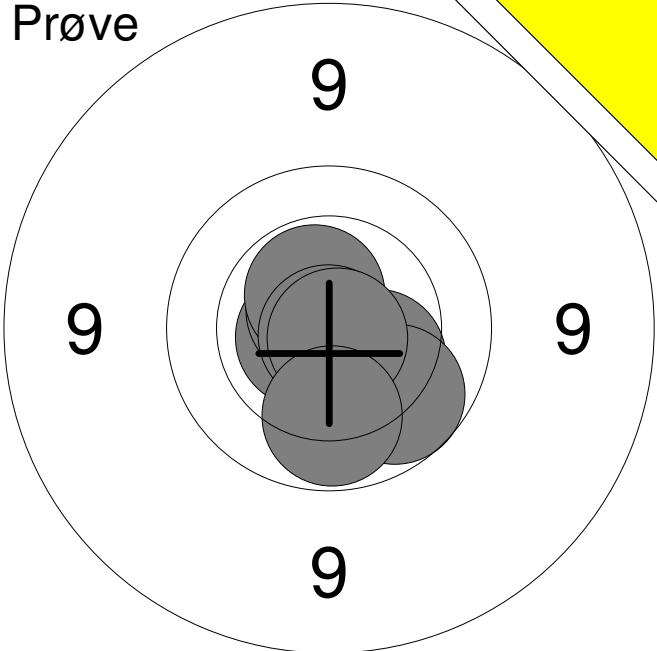
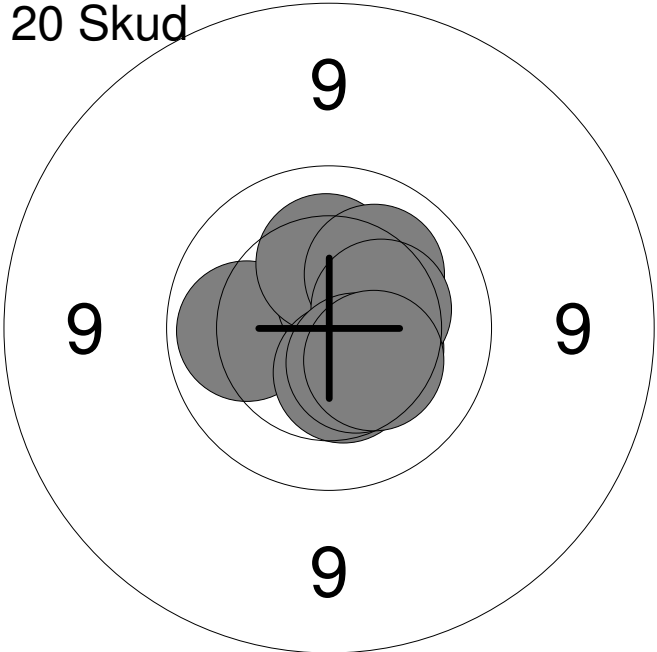
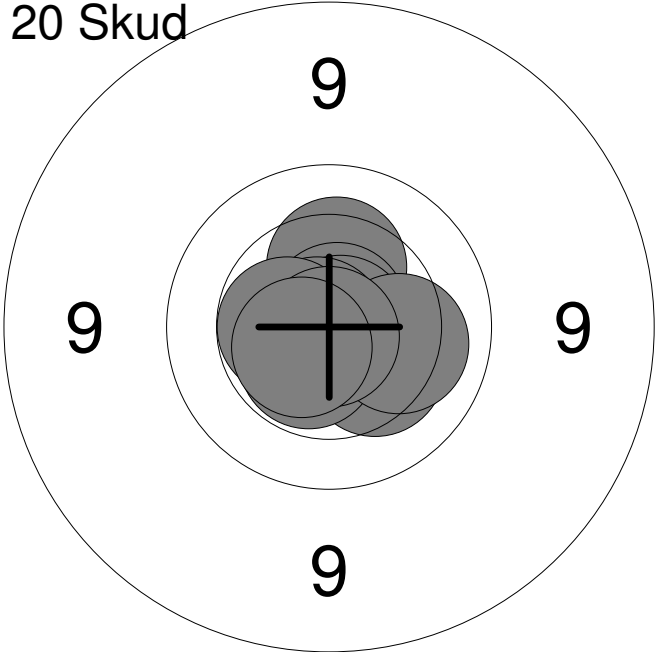
| Hold | Skive | Christine Jacobi | |
|---------|--|---------------------|--------------|
| 30 | 8 | | |
| 15m | Viborg Skytteforening | J2 | |
| | 15 meter riffelstævne oktober 2 | Aalborg Skyttekreds | |
| Prøve |  | 1: 10.2 | ↓ |
| | | 2: 10.2 | ↓ |
| | | 3: 10.7x | ← |
| | | 4: 10.7x | ↗ |
| | | 5: 10.6x | ↗ |
| | | 6: 10.9x | ↓ |
| | | 7: 10.3 | ↓ |
| | | 8: 9.9 | ↓ |
| | | 9: 10.8x | ↓ |
| | | 10: 10.0 | ↓ |
| | | Serie | 99.0 |
| | | Total | 0.0 |
| 20 Skud |  | 1: 10.1 | ← |
| | | 2: 10.5x | → |
| | | 3: 10.4 | → |
| | | 4: 10.6x | ↗ |
| | | 5: 10.3 | ↑ |
| | | 6: 10.2 | ↗ |
| | | 7: 10.3 | → |
| | | 8: 10.4 | ↓ |
| | | 9: 10.5 | ↓ |
| | | 10: 10.3 | ↓ |
| | | Serie | 100.0 |
| | | Total | 100.0 |
| 20 Skud |  | 11: 10.3 | ↑ |
| | | 12: 10.3 | ↓ |
| | | 13: 10.8x | ↗ |
| | | 14: 10.8x | → |
| | | 15: 10.8x | ← |
| | | 16: 10.5x | ↙ |
| | | 17: 10.5x | ← |
| | | 18: 10.2 | → |
| | | 19: 10.8x | ↓ |
| | | 20: 10.6x | ↙ |
| | | Serie | 100.0 |
| | | Total | 200.0 |

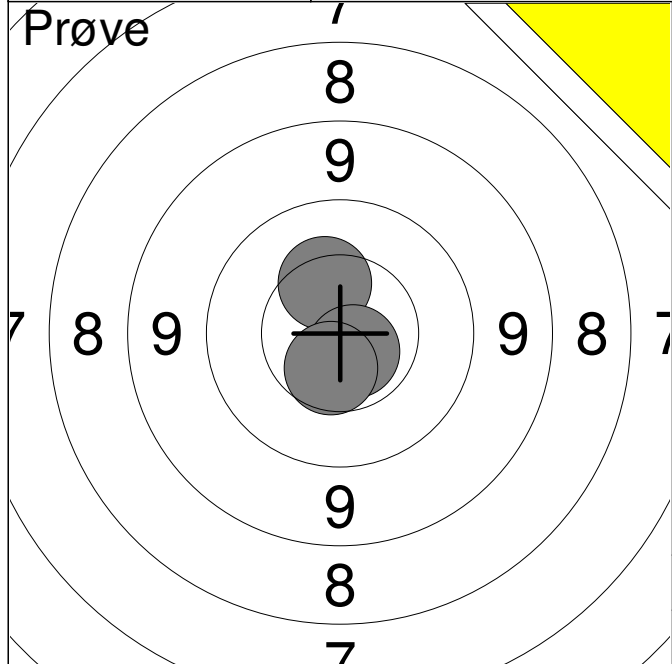

| | | | |
|--------------|----|-------------|---|
| | 1: | 10.3 | ↑ |
| | 2: | 10.7x | ↓ |
| | 3: | 10.5 | ↓ |
| Serie | | 30.0 | |
| Total | | 0.0 | |

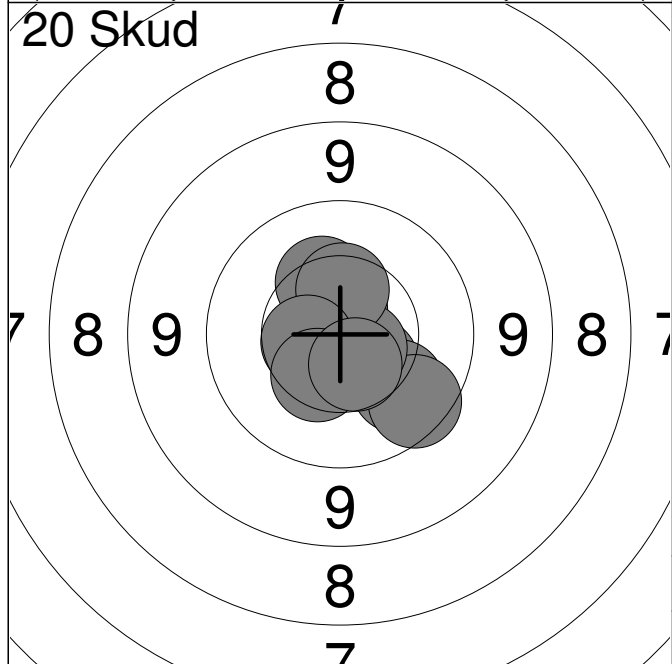

| | | | |
|--------------|-----|-------------|---|
| | 1: | 10.3 | ↑ |
| | 2: | 10.4 | ↓ |
| | 3: | 10.0 | ↓ |
| | 4: | 9.8 | ↓ |
| | 5: | 10.7x | ↑ |
| | 6: | 10.7x | ↓ |
| | 7: | 10.4 | ↑ |
| | 8: | 10.6 | ← |
| | 9: | 10.4 | ↓ |
| | 10: | 10.6 | ↓ |
| Serie | | 99.0 | |
| Total | | 99.0 | |

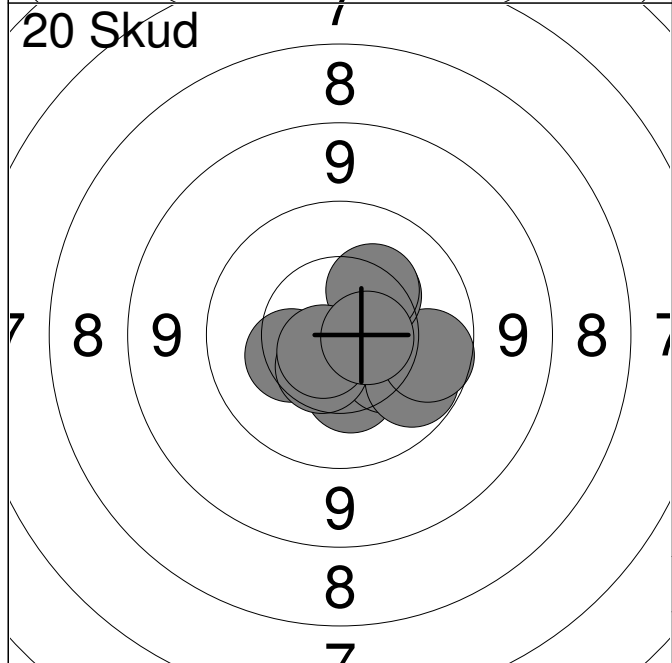

| | | | |
|--------------|-----|--------------|---|
| | 11: | 10.3 | ↓ |
| | 12: | 10.3 | ↓ |
| | 13: | 10.3 | ← |
| | 14: | 10.0 | ↓ |
| | 15: | 10.5 | ↓ |
| | 16: | 9.9 | → |
| | 17: | 10.3 | ↗ |
| | 18: | 10.3 | ↗ |
| | 19: | 10.7x | ↓ |
| | 20: | 10.6x | → |
| Serie | | 99.0 | |
| Total | | 198.0 | |

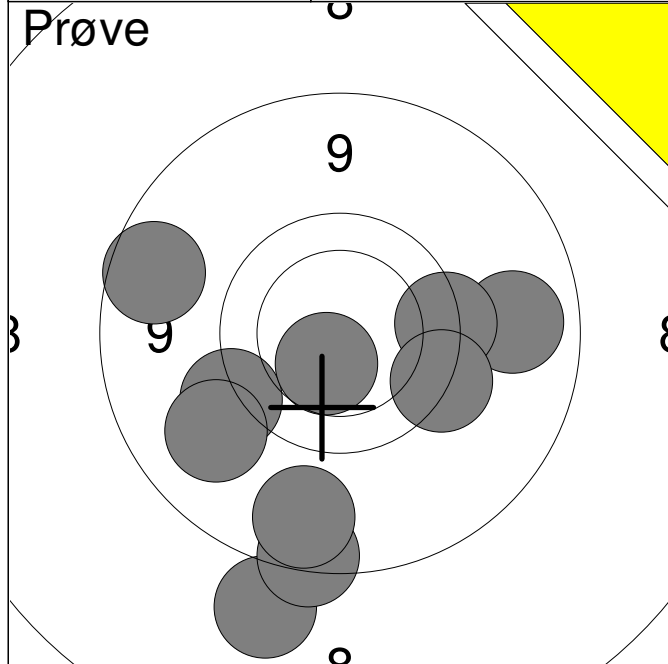

| | | |
|-----|------|---|
| 1: | 8.4 | ↓ |
| 2: | 8.8 | ↓ |
| 3: | 9.0 | ↓ |
| 4: | 9.1 | → |
| 5: | 9.6 | → |
| 6: | 9.5 | ↙ |
| 7: | 9.6 | → |
| 8: | 10.5 | ↓ |
| 9: | 9.2 | ↙ |
| 10: | 8.9 | ↖ |

| | |
|--------------|-------------|
| Serie | 88.0 |
| Total | 0.0 |

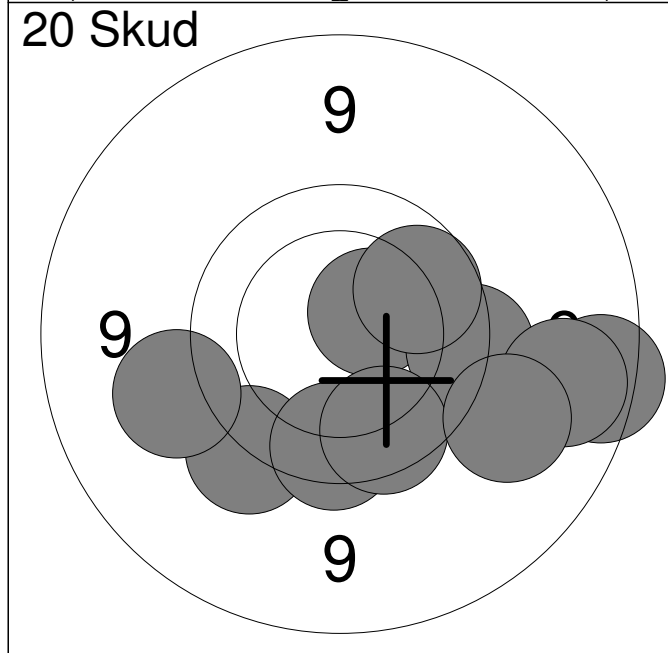

| | | |
|-----|-------|---|
| 1: | 10.5x | ↗ |
| 2: | 9.5 | ↙ |
| 3: | 9.8 | ↓ |
| 4: | 8.8 | → |
| 5: | 9.6 | → |
| 6: | 9.8 | ↙ |
| 7: | 9.4 | ↖ |
| 8: | 9.9 | ↗ |
| 9: | 9.0 | → |
| 10: | 9.3 | ↘ |

| | |
|--------------|-------------|
| Serie | 90.0 |
| Total | 90.0 |

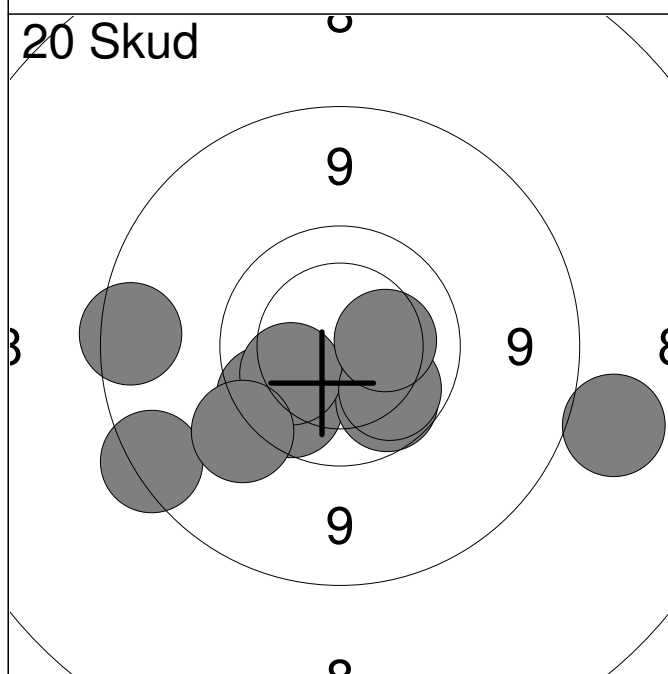

| | | |
|-----|------|---|
| 11: | 8.8 | ↖ |
| 12: | 8.8 | ↖ |
| 13: | 9.8 | ↖ |
| 14: | 9.9 | ↙ |
| 15: | 9.9 | ↙ |
| 16: | 10.1 | ↖ |
| 17: | 9.4 | ↖ |
| 18: | 10.0 | ↙ |
| 19: | 8.4 | → |
| 20: | 10.3 | → |

| | |
|--------------|--------------|
| Serie | 90.0 |
| Total | 180.0 |

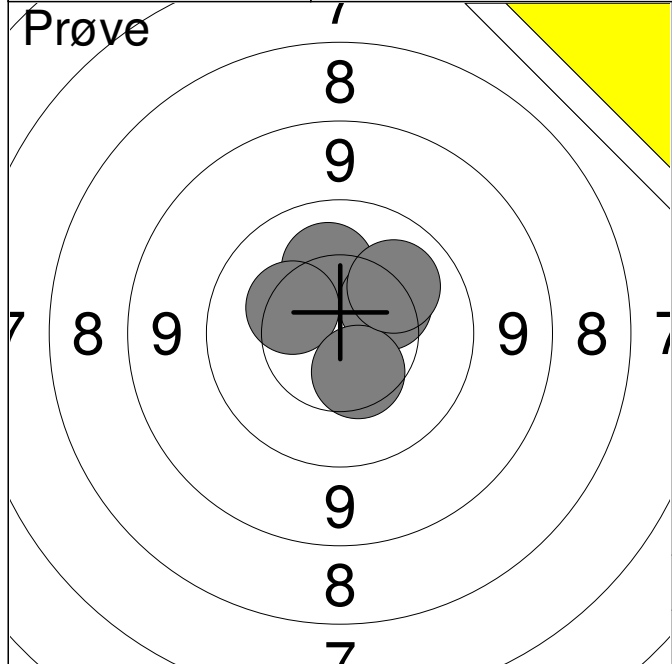

| | | |
|--------------|------|-------------|
| 1: | 10.2 | ↑ |
| 2: | 10.3 | ↗ |
| 3: | 10.3 | ↗ |
| 4: | 10.5 | ↓ |
| 5: | 10.1 | ↗ |
| Serie | | 50.0 |
| Total | | 0.0 |

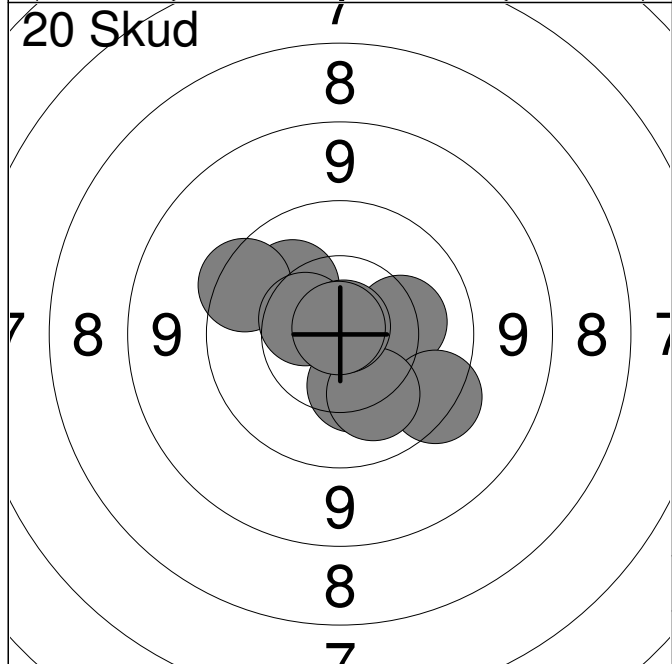

| | | |
|--------------|-------|-------------|
| 1: | 10.3 | ↓ |
| 2: | 10.2 | ↗ |
| 3: | 10.6x | → |
| 4: | 10.2 | → |
| 5: | 9.6 | ↓ |
| 6: | 10.2 | ↓ |
| 7: | 9.7 | ↗ |
| 8: | 10.5 | ↗ |
| 9: | 10.8x | ↗ |
| 10: | 10.9x | ↑ |
| Serie | | 98.0 |
| Total | | 98.0 |

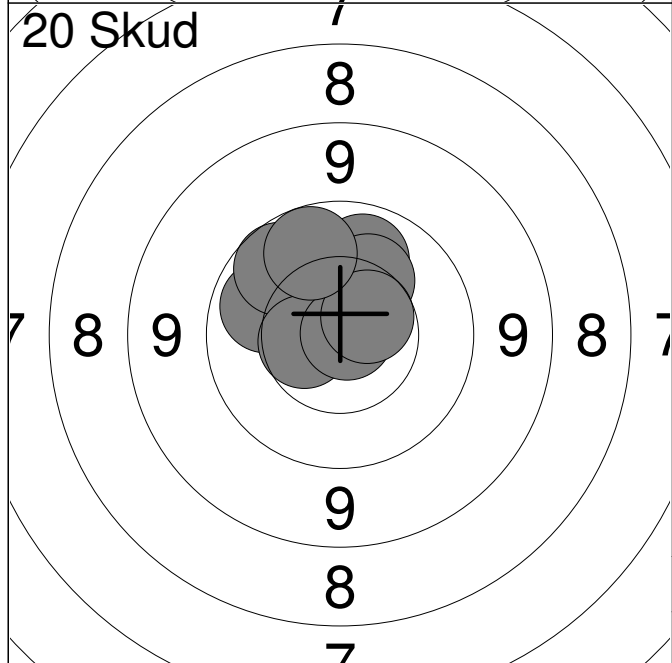

| | | |
|--------------|-------|--------------|
| 11: | 10.0 | ↑ |
| 12: | 10.7x | ↗ |
| 13: | 10.0 | ↗ |
| 14: | 10.2 | ↗ |
| 15: | 10.0 | ↗ |
| 16: | 9.9 | ↗ |
| 17: | 10.5 | ← |
| 18: | 10.9x | → |
| 19: | 10.6 | ↗ |
| 20: | 9.9 | ↑ |
| Serie | | 98.0 |
| Total | | 196.0 |

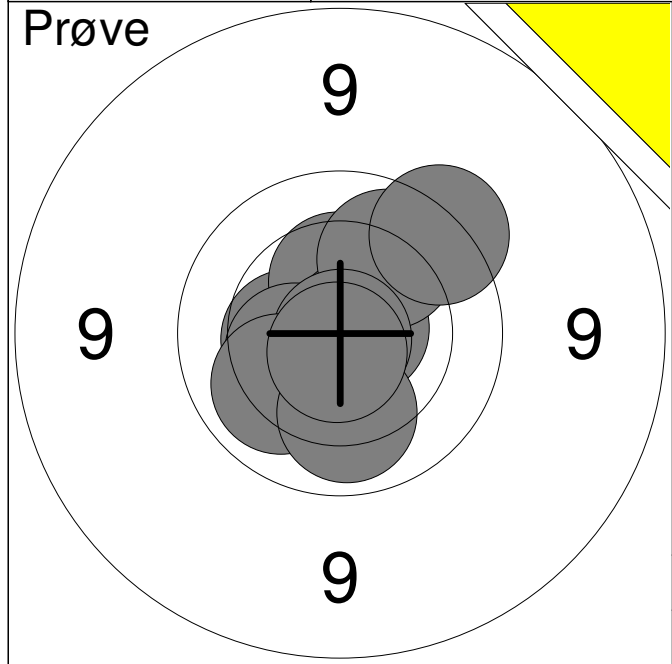

| | | |
|--------------|-------|-------------|
| 1: | 10.4 | ← |
| 2: | 10.4 | ↑ |
| 3: | 10.7x | → |
| 4: | 10.0 | ↗ |
| 5: | 9.7 | ↗ |
| 6: | 10.4 | ← |
| 7: | 10.9x | ↓ |
| 8: | 10.1 | ← |
| 9: | 10.1 | ↓ |
| 10: | 10.7x | ↓ |
| Serie | | 99.0 |
| Total | | 0.0 |

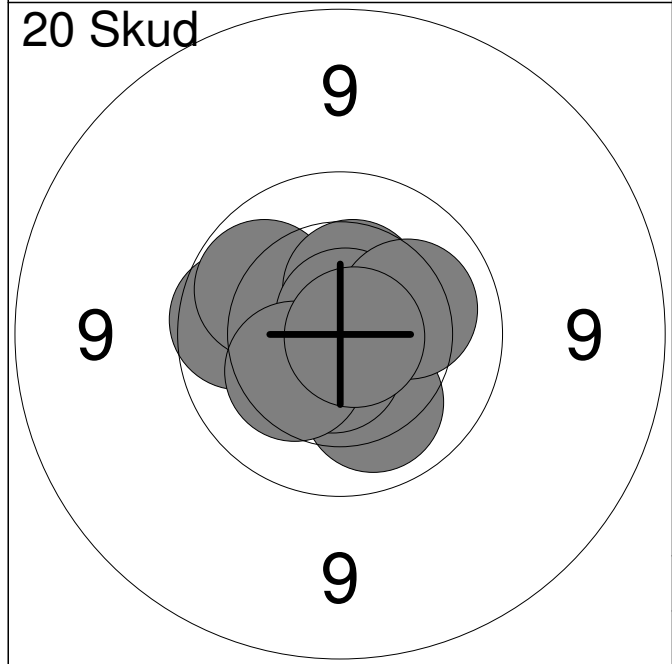

| | | |
|--------------|-------|-------------|
| 1: | 9.9 | ← |
| 2: | 10.0 | ↖ |
| 3: | 10.4 | ↑ |
| 4: | 10.8x | ↑ |
| 5: | 10.6x | ↓ |
| 6: | 10.1 | ↓ |
| 7: | 10.2 | → |
| 8: | 10.6x | ↓ |
| 9: | 10.3 | ↙ |
| 10: | 10.8x | → |
| Serie | | 99.0 |
| Total | | 99.0 |

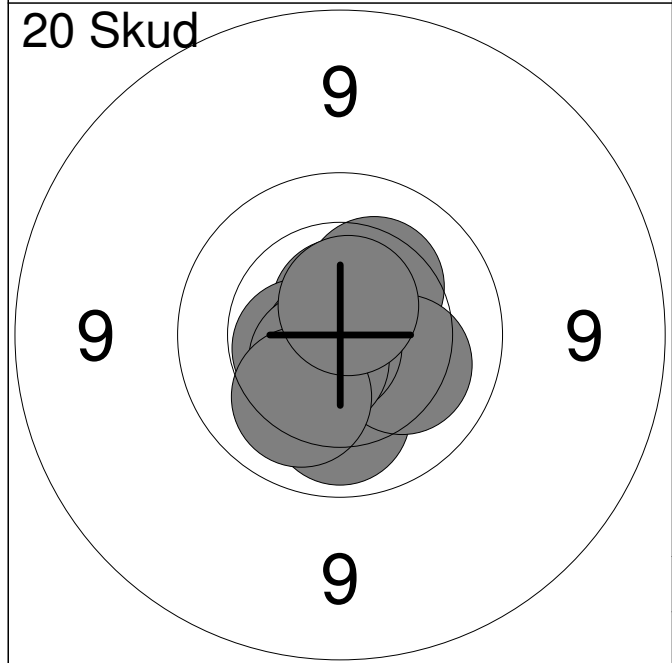

| | | |
|--------------|-------|--------------|
| 11: | 10.7x | ↑ |
| 12: | 10.3 | ↗ |
| 13: | 10.1 | ↓ |
| 14: | 10.5x | ← |
| 15: | 10.6x | ↓ |
| 16: | 10.2 | → |
| 17: | 10.8x | ↙ |
| 18: | 10.6x | ↙ |
| 19: | 10.2 | ↙ |
| 20: | 10.6x | ↑ |
| Serie | | 100.0 |
| Total | | 199.0 |

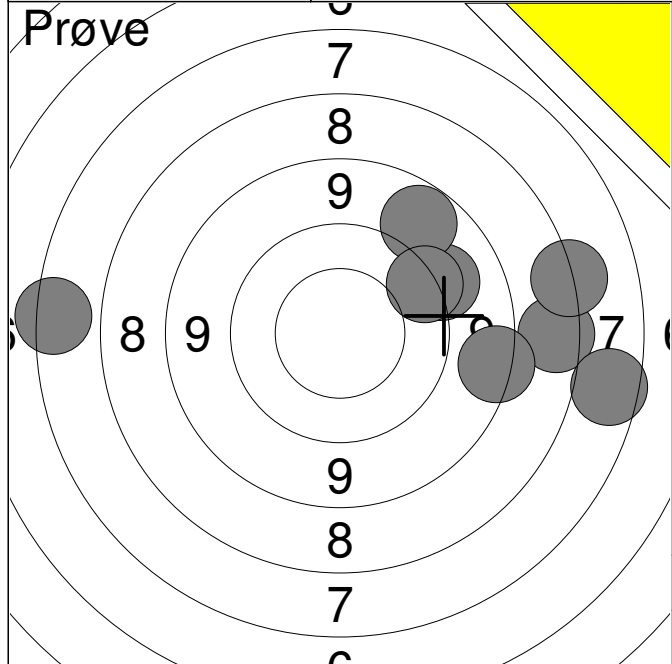

| | | |
|--------------|-----|-------------|
| 1: | 7.7 | → |
| 2: | 9.3 | ↗ |
| 3: | 6.6 | ← |
| 4: | 6.8 | → |
| 5: | 7.4 | → |
| 6: | 9.0 | ↗ |
| 7: | 8.6 | → |
| 8: | 9.5 | ↗ |
| Serie | | 61.0 |
| Total | | 0.0 |

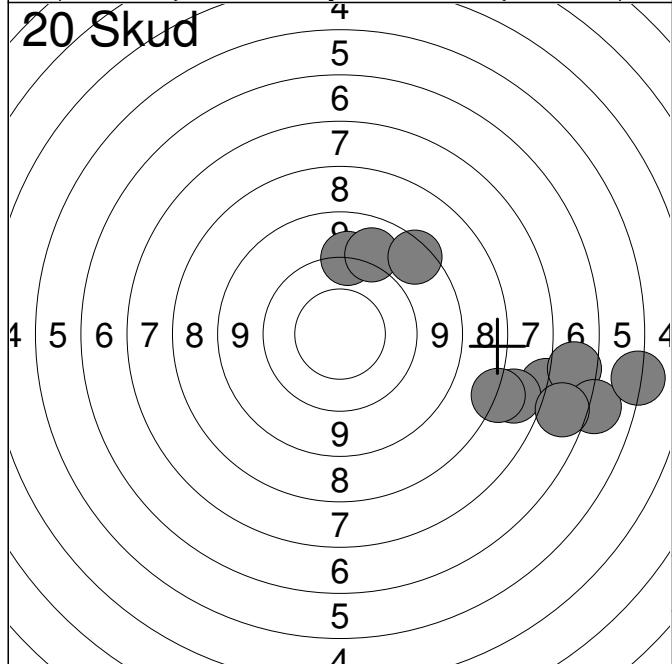

| | | |
|--------------|-----|-------------|
| 1: | 6.4 | → |
| 2: | 9.4 | ↑ |
| 3: | 9.2 | ↑ |
| 4: | 7.0 | → |
| 5: | 5.8 | → |
| 6: | 5.2 | → |
| 7: | 5.9 | → |
| 8: | 7.3 | → |
| 9: | 8.7 | ↗ |
| 10: | 4.4 | → |
| Serie | | 65.0 |
| Total | | 65.0 |

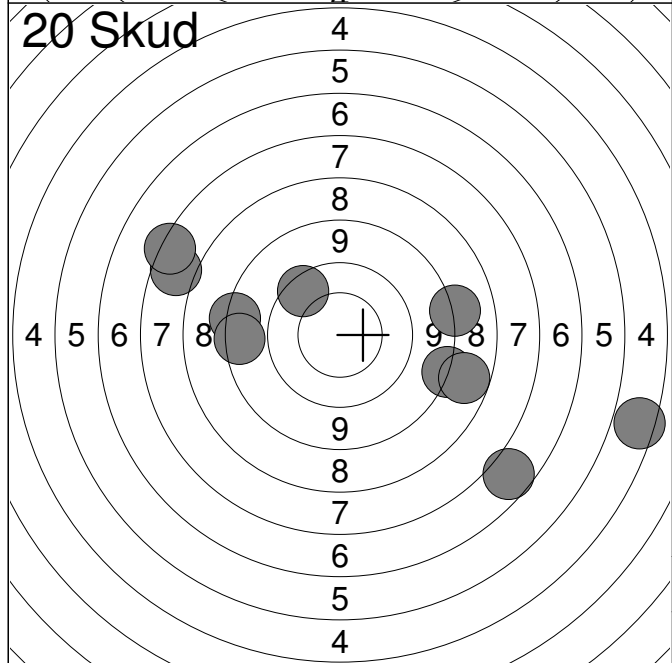

| | | |
|--------------|-----|--------------|
| 11: | 5.9 | ↘ |
| 12: | 3.7 | → |
| 13: | 6.9 | ↖ |
| 14: | 8.4 | → |
| 15: | 8.0 | → |
| 16: | 6.6 | ↖ |
| 17: | 9.7 | ↗ |
| 18: | 8.5 | ← |
| 19: | 8.3 | → |
| 20: | 8.7 | ← |
| Serie | | 69.0 |
| Total | | 134.0 |

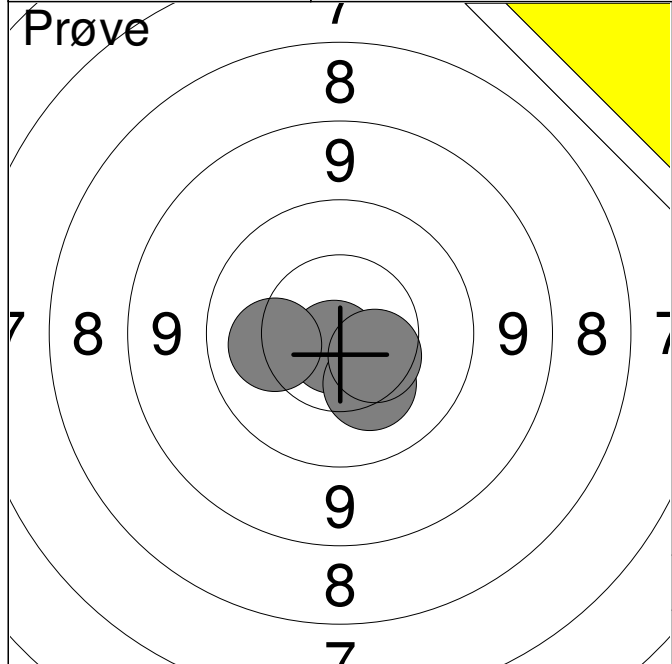

| | | | |
|--------------|----|-------|-------------|
| | 1: | 10.8x | ↘ |
| | 2: | 10.2 | ← |
| | 3: | 10.3 | ↘ |
| | 4: | 10.5 | ↘ |
| Serie | | | 40.0 |
| Total | | | 0.0 |

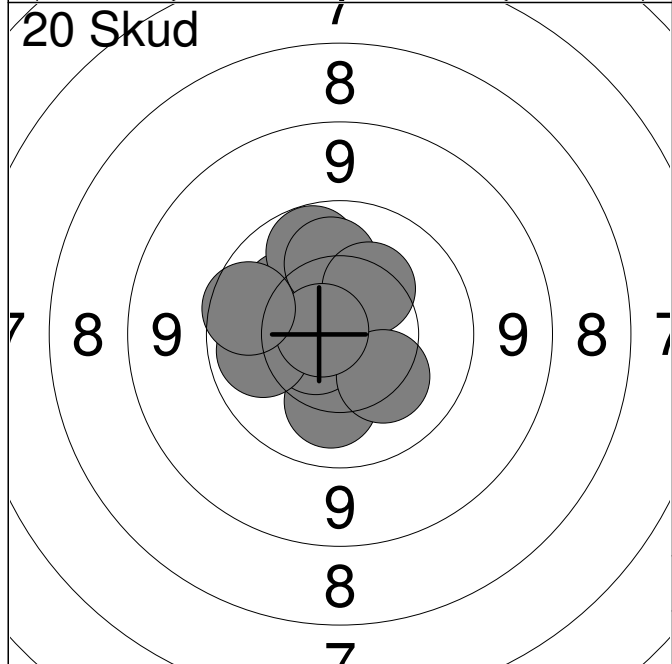

| | | | |
|--------------|-----|-------|-------------|
| | 1: | 10.2 | ↗ |
| | 2: | 10.2 | ↓ |
| | 3: | 10.6x | ↙ |
| | 4: | 10.0 | ← |
| | 5: | 10.0 | ↑ |
| | 6: | 10.1 | ↑ |
| | 7: | 10.3 | ↗ |
| | 8: | 10.3 | ↘ |
| | 9: | 10.7x | ← |
| | 10: | 9.8 | ← |
| Serie | | | 99.0 |
| Total | | | 99.0 |

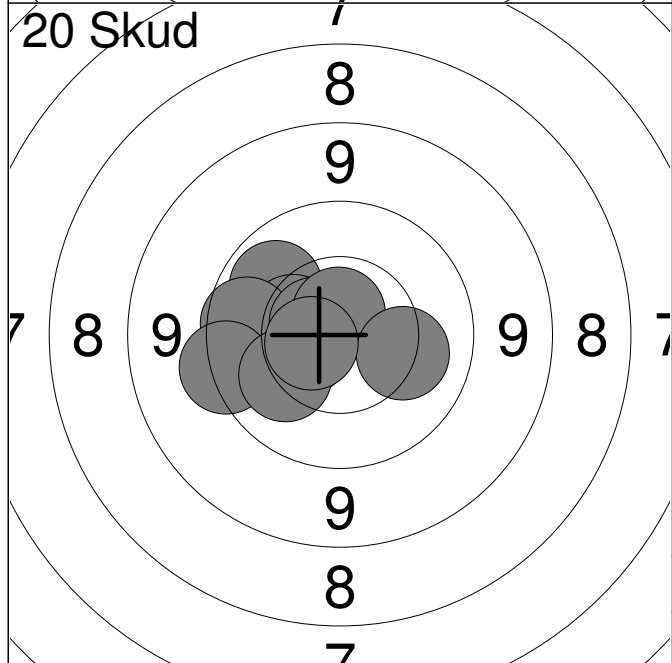

| | | | |
|--------------|-----|-------|--------------|
| | 11: | 10.0 | ↗ |
| | 12: | 10.5 | ↙ |
| | 13: | 10.4 | ↙ |
| | 14: | 9.9 | ← |
| | 15: | 9.5 | ↙ |
| | 16: | 10.6x | ↗ |
| | 17: | 10.7x | ↑ |
| | 18: | 10.2 | ↙ |
| | 19: | 10.2 | → |
| | 20: | 10.6x | ← |
| Serie | | | 98.0 |
| Total | | | 197.0 |

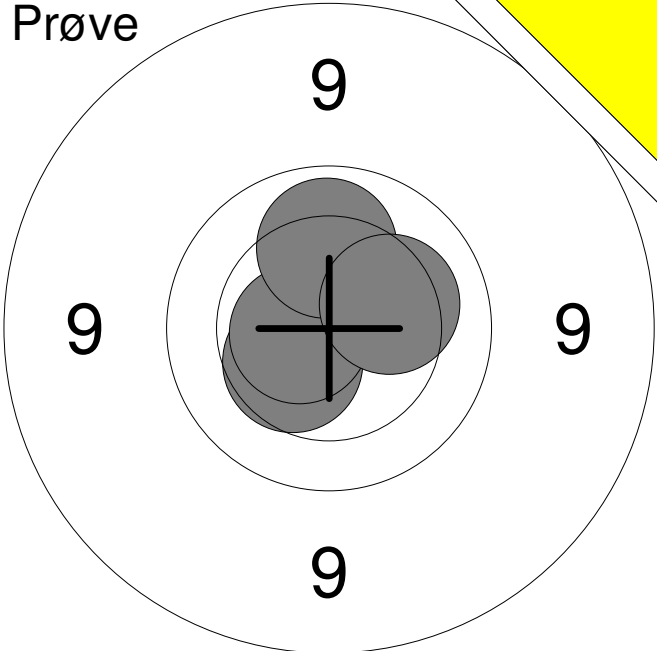
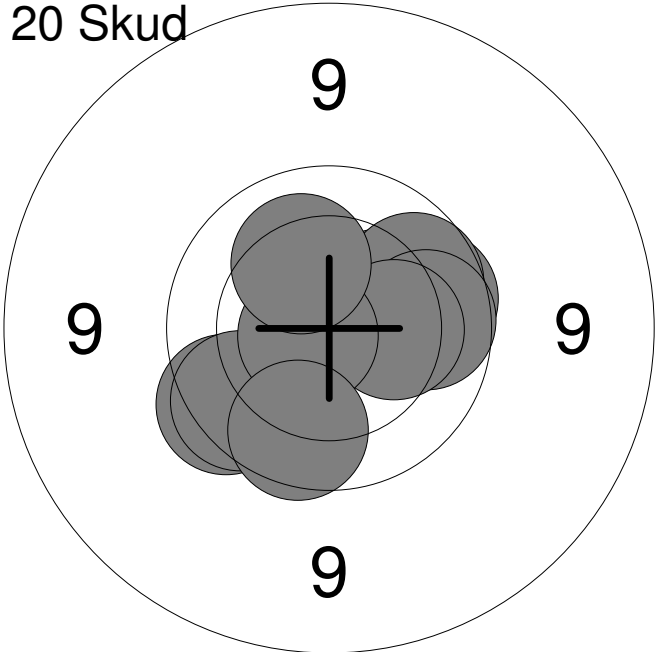
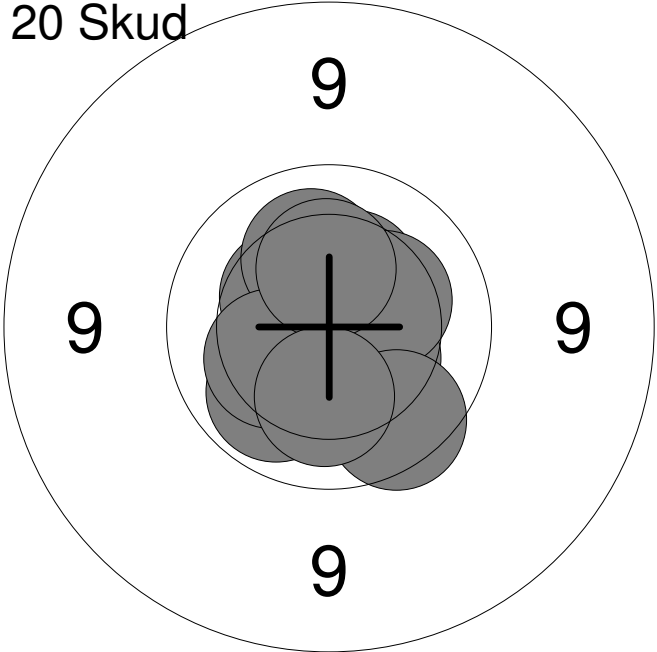
| Hold | Skive | Lisbeth Stricker Jensen | |
|---------|--|-------------------------|--|
| 31 | 3 | | |
| 15m | Vodskov Skytteforening | MÅ2 | |
| | 15 meter riffelstævne oktober 2 | Aalborg Skyttekreds | |
| Prøve |  | 1: 10.4 ↘ | |
| | | 2: 10.6x ← | |
| | | 3: 10.1 ↑ | |
| | | 4: 10.2 → | |
| | Serie | 40.0 | |
| | Total | 0.0 | |
| 20 Skud |  | 1: 10.3 → | |
| | | 2: 9.9 → | |
| | | 3: 9.7 ↘ | |
| | | 4: 9.8 ↘ | |
| | | 5: 9.9 → | |
| | | 6: 9.9 → | |
| | | 7: 10.2 → | |
| | | 8: 10.7x ← | |
| | | 9: 9.9 ↓ | |
| | | 10: 10.2 ↑ | |
| | Serie | 94.0 | |
| | Total | 94.0 | |
| 20 Skud |  | 11: 10.4 ↘ | |
| | | 12: 10.0 ↘ | |
| | | 13: 10.4 ↗ | |
| | | 14: 10.4 ↑ | |
| | | 15: 10.2 ↑ | |
| | | 16: 10.3 → | |
| | | 17: 10.3 ↘ | |
| | | 18: 9.8 ↓ | |
| | | 19: 10.3 ↑ | |
| | | 20: 10.2 ↓ | |
| | Serie | 99.0 | |
| | Total | 193.0 | |

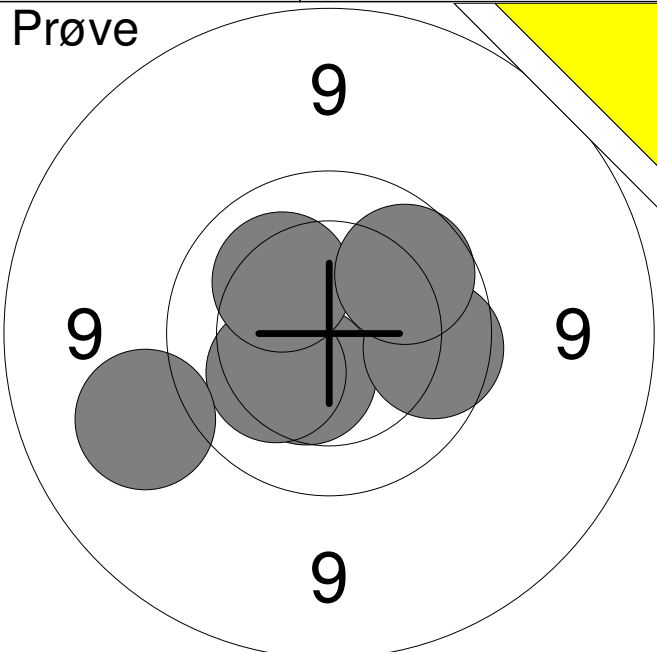
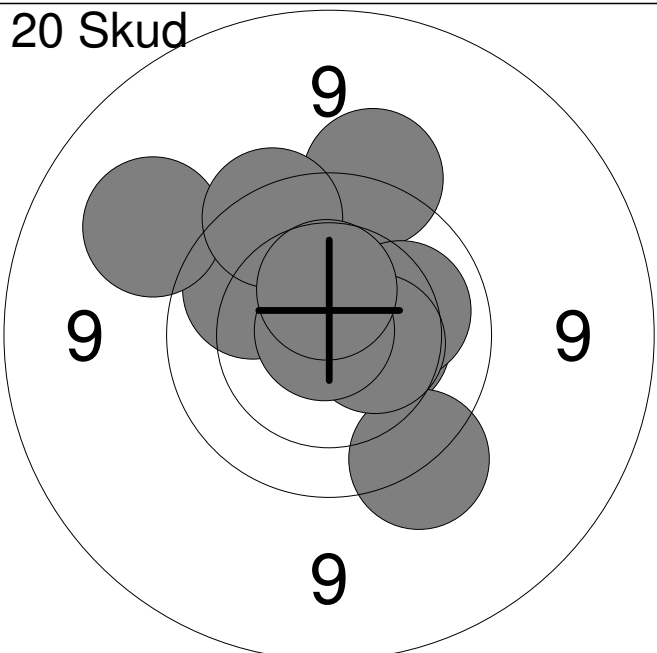
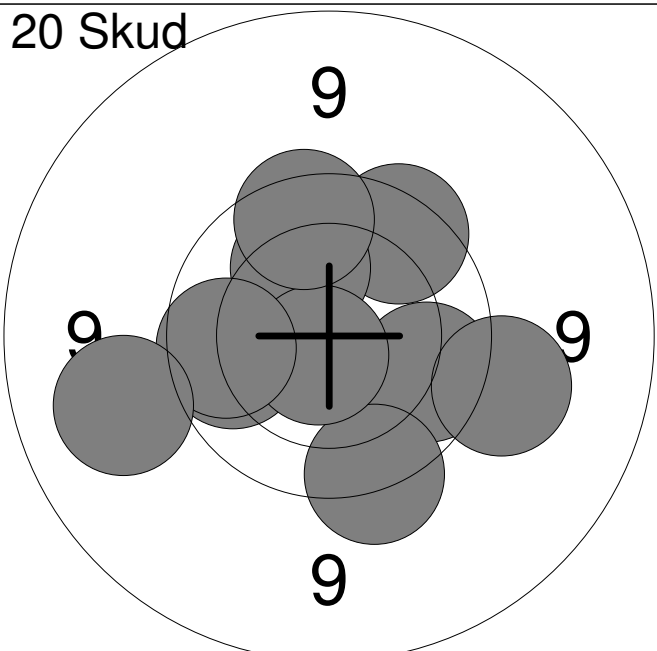
| Hold | Skive | Svend Peter Larsen | |
|---------|--|---------------------|--|
| 31 | 4 | | |
| 15m | Sæby og Omegns Skytteforening | V2 | |
| | 15 meter riffelstævne oktober 2 | Aalborg Skyttekreds | |
| Prøve |  | 1: 10.4 ↙ | |
| | | 2: 10.2 ↙ | |
| | | 3: 9.3 ↙ | |
| | | 4: 9.9 → | |
| | | 5: 10.2 ↗ | |
| | | 6: 9.9 ↗ | |
| | Serie | 57.0 | |
| | Total | 0.0 | |
| 20 Skud |  | 1: 9.5 ↑ | |
| | | 2: 10.0 ↗ | |
| | | 3: 10.4 → | |
| | | 4: 9.6 ↘ | |
| | | 5: 10.1 → | |
| | | 6: 9.2 ↗ | |
| | | 7: 10.4 → | |
| | | 8: 9.7 ↗ | |
| | | 9: 10.9x ↗ | |
| | | 10: 10.5 ↑ | |
| | Serie | 96.0 | |
| | Total | 96.0 | |
| 20 Skud |  | 11: 9.9 ← | |
| | | 12: 9.9 → | |
| | | 13: 9.8 ↗ | |
| | | 14: 9.6 ↘ | |
| | | 15: 10.2 ↗ | |
| | | 16: 9.4 → | |
| | | 17: 10.7x ↘ | |
| | | 18: 9.9 ← | |
| | | 19: 9.8 ↑ | |
| | | 20: 9.2 ← | |
| | Serie | 92.0 | |
| | Total | 188.0 | |

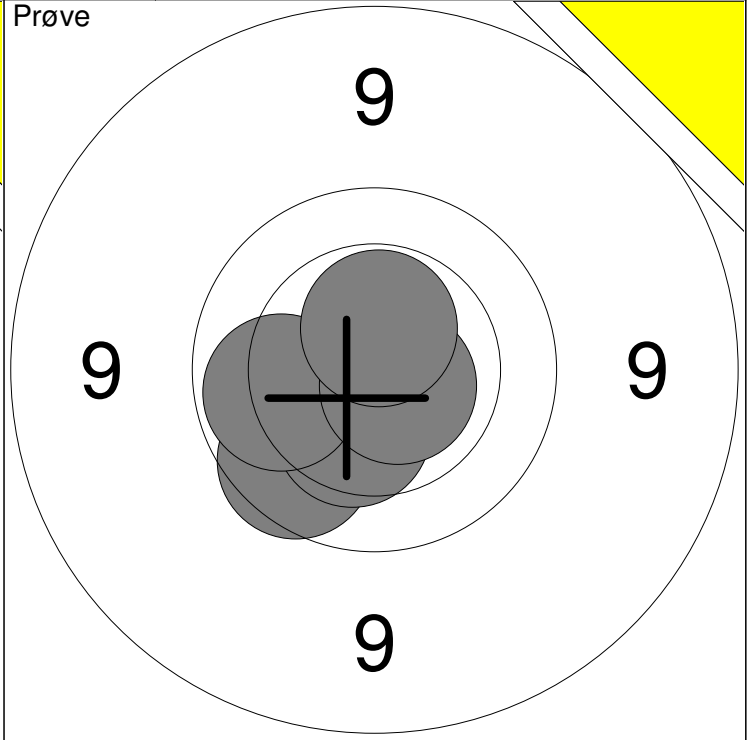
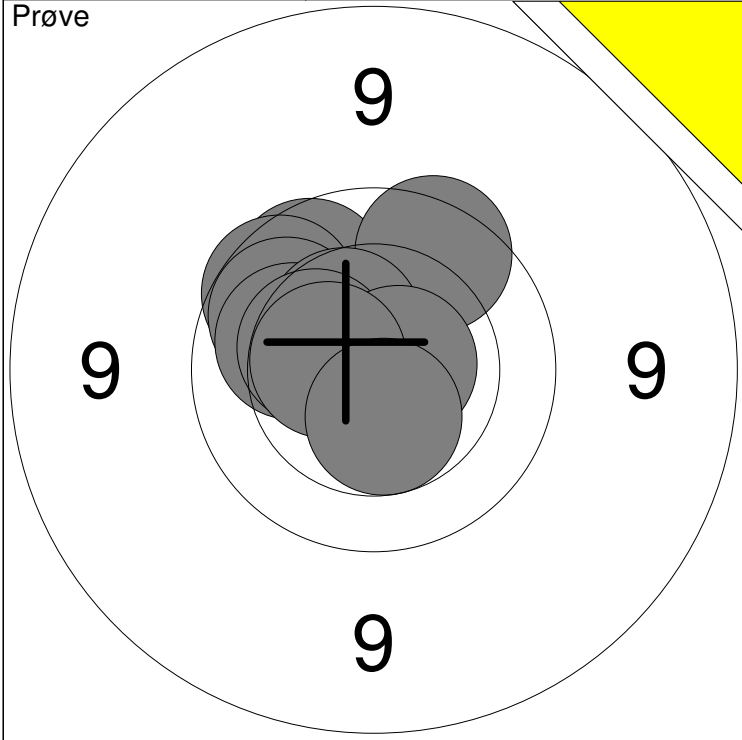

| | | | |
|-----------|------------|-------|----|
| 1: 9.9 ↗ | 6: 10.4 ↗ | Serie | 97 |
| 2: 9.9 ↗ | 7: 10.3 ↖ | | |
| 3: 10.0 ↗ | 8: 10.7x → | Total | 0 |
| 4: 9.8 ↗ | 9: 10.5x ↖ | | |
| 5: 10.1 ↖ | 10: 10.5 ↓ | | |

| | | |
|-------------|-------|----|
| 11: 9.9 ↙ | Serie | 49 |
| 12: 10.3 ↓ | | |
| 13: 10.0 ← | Total | 0 |
| 14: 10.7x ↘ | | |
| 15: 10.5x ↑ | | |

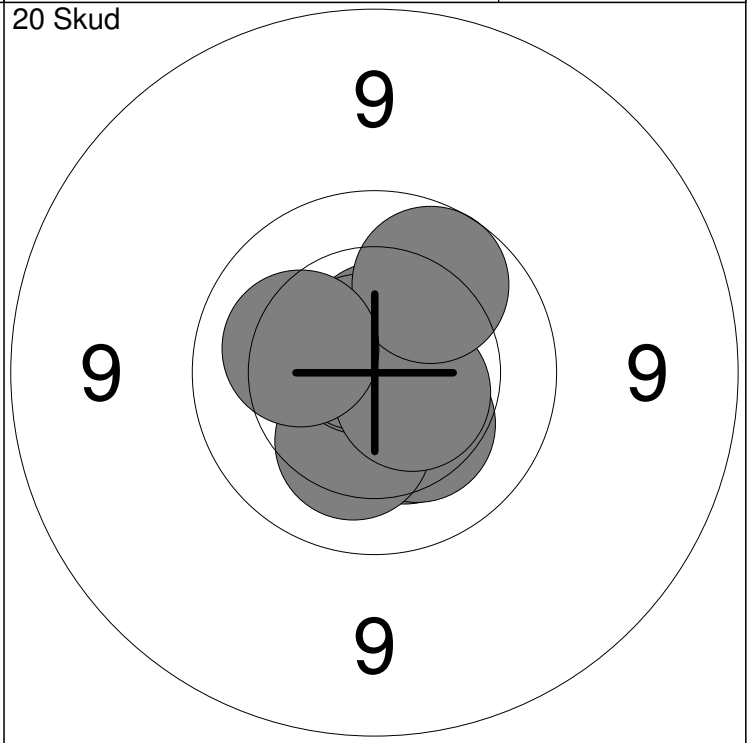
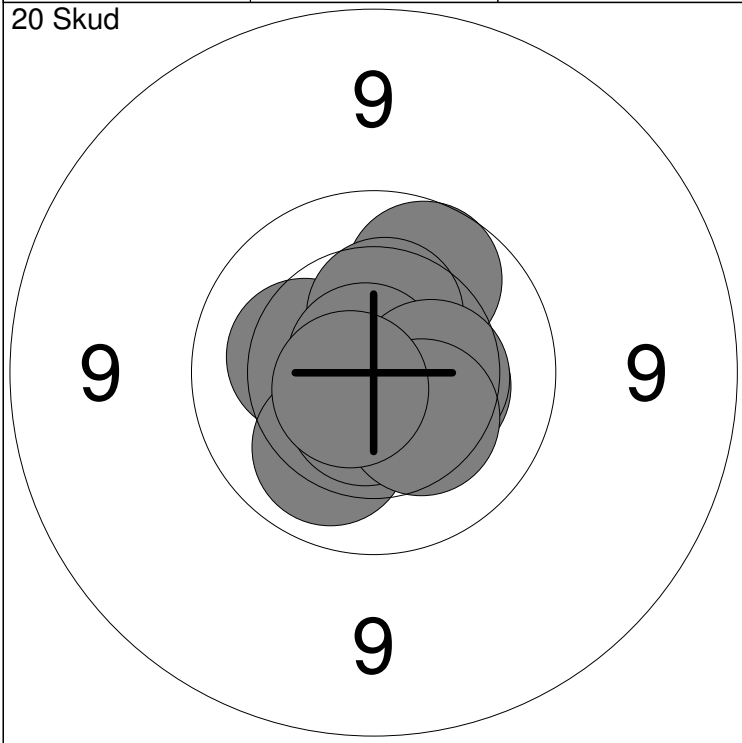

| | | | |
|-----------|-------------|-------|----|
| 1: 10.3 ← | 6: 10.8x ↗ | Serie | 99 |
| 2: 10.1 ↓ | 7: 10.6x ↓ | | |
| 3: 10.4 → | 8: 10.4 → | Total | 99 |
| 4: 9.9 ↗ | 9: 10.3 ↓ | | |
| 5: 10.4 ↑ | 10: 10.7x ↖ | | |

| | | | |
|-------------|-------------|-------|-----|
| 11: 10.4 ↓ | 16: 10.8x ↗ | Serie | 99 |
| 12: 10.5 ↓ | 17: 10.7x ↗ | | |
| 13: 10.3 ↓ | 18: 10.5x ↘ | Total | 198 |
| 14: 10.3 ↓ | 19: 9.9 ↗ | | |
| 15: 10.6x ↑ | 20: 10.2 ← | | |

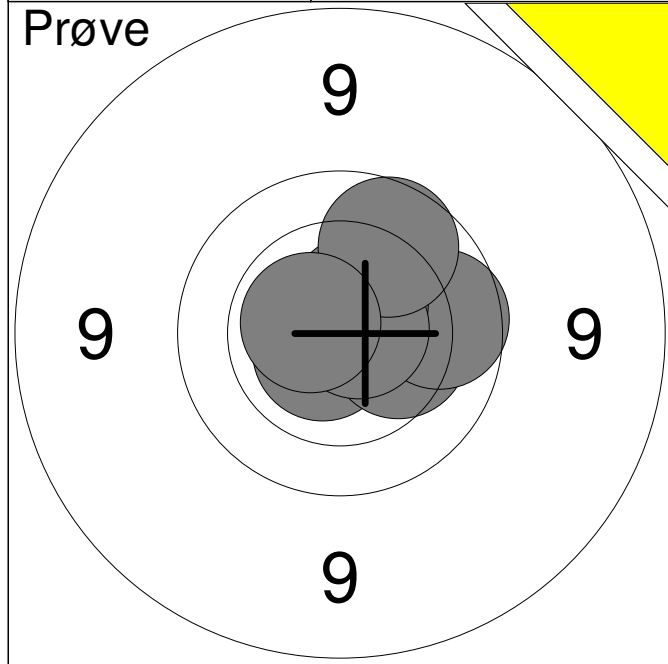

| | | |
|----|-------|---|
| 1: | 10.7x | ↙ |
| 2: | 10.3 | → |
| 3: | 9.9 | → |
| 4: | 10.6x | ↗ |
| 5: | 10.7x | → |
| 6: | 9.9 | ↗ |
| 7: | 10.6x | ↖ |

| | |
|-------|------|
| Serie | 68.0 |
| Total | 0.0 |

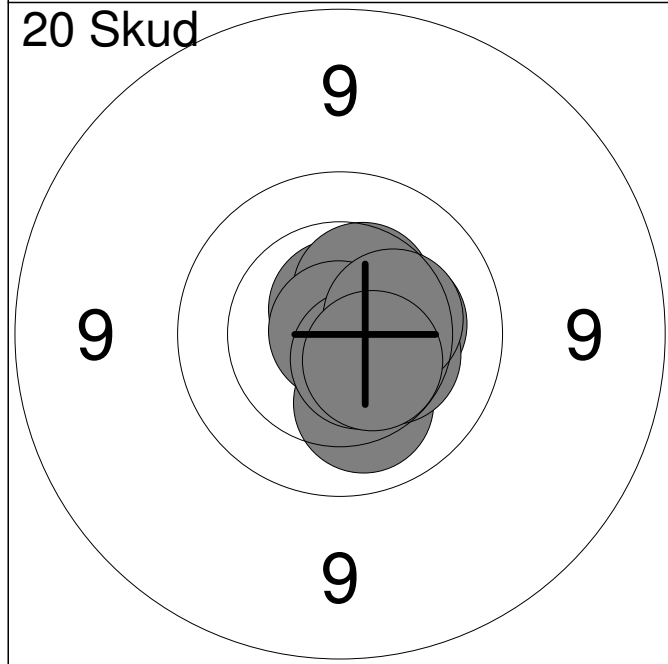

| | | |
|-----|-------|---|
| 1: | 10.6x | → |
| 2: | 10.7x | ↑ |
| 3: | 10.2 | ↓ |
| 4: | 10.3 | → |
| 5: | 10.4 | ↗ |
| 6: | 10.4 | ↘ |
| 7: | 10.9x | ↗ |
| 8: | 10.6x | ↓ |
| 9: | 10.4 | → |
| 10: | 10.5x | ↓ |

| | |
|-------|-------|
| Serie | 100.0 |
| Total | 100.0 |

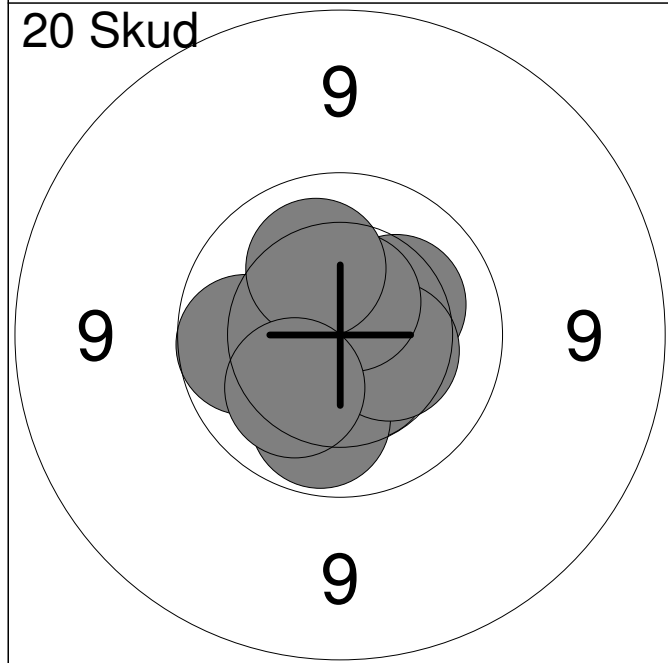

| | | |
|-----|-------|---|
| 11: | 10.3 | ↗ |
| 12: | 10.9x | ← |
| 13: | 10.5x | ↓ |
| 14: | 10.8x | ↗ |
| 15: | 9.9 | ← |
| 16: | 10.0 | ↓ |
| 17: | 10.4 | → |
| 18: | 10.6x | ↗ |
| 19: | 10.2 | ↗ |
| 20: | 10.2 | ↙ |

| | |
|-------|-------|
| Serie | 99.0 |
| Total | 199.0 |

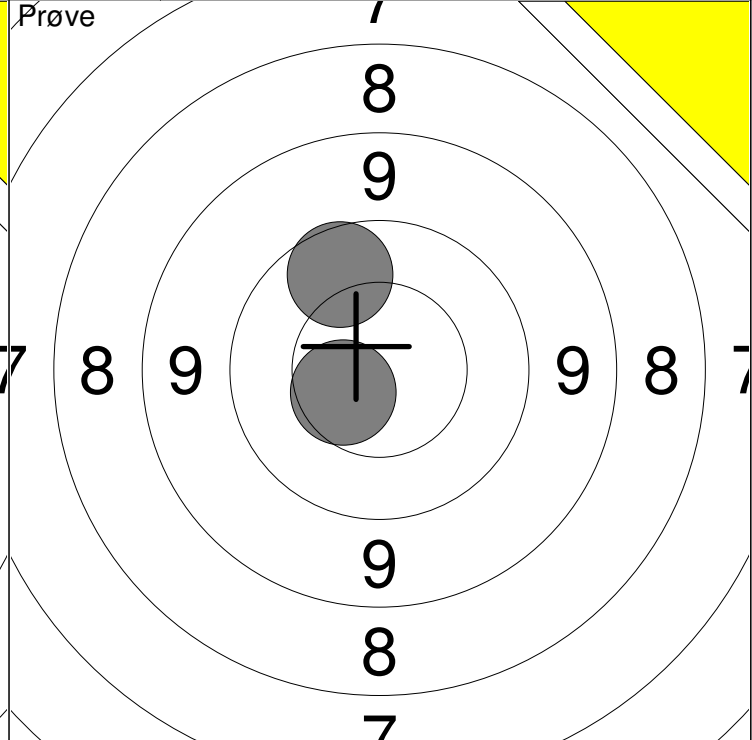
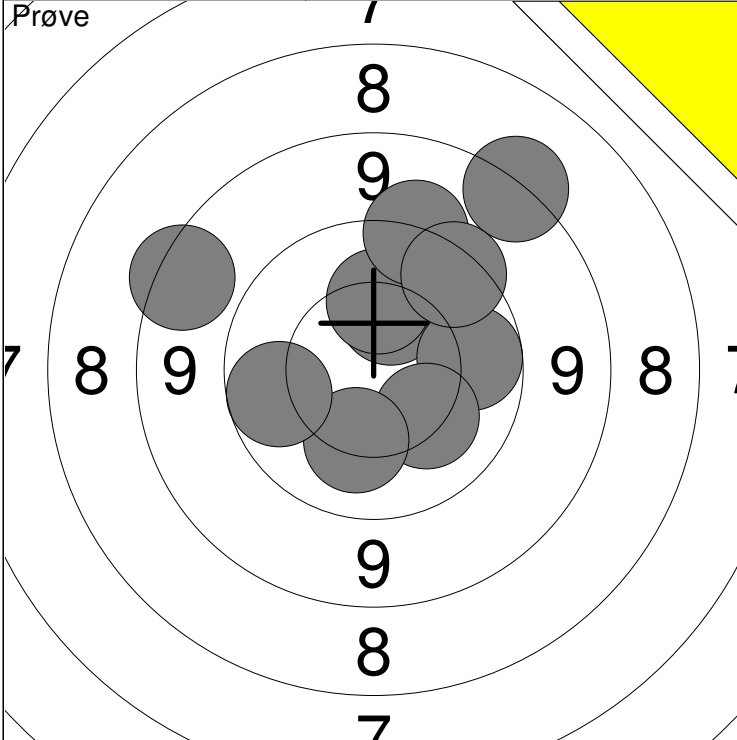

| | | | |
|-----------|-----------|-------|----|
| 1: 10.3 ↑ | 6: 8.4 ↗ | Serie | 92 |
| 2: 10.2 ↑ | 7: 9.6 ↗ | | |
| 3: 9.9 → | 8: 10.2 ↓ | Total | 0 |
| 4: 10.2 ↘ | 9: 9.9 ← | | |
| 5: 9.4 ↑ | 10: 8.6 ↖ | | |

| | | |
|------------|-------|----|
| 11: 9.9 ↑ | Serie | 19 |
| 12: 10.5 ↙ | | |
| | Total | 0 |
| | | |

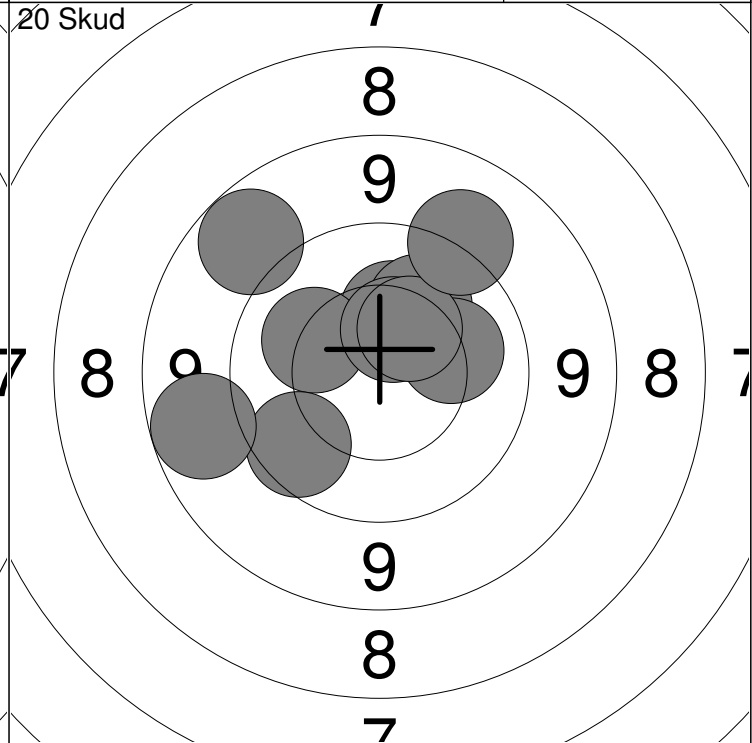
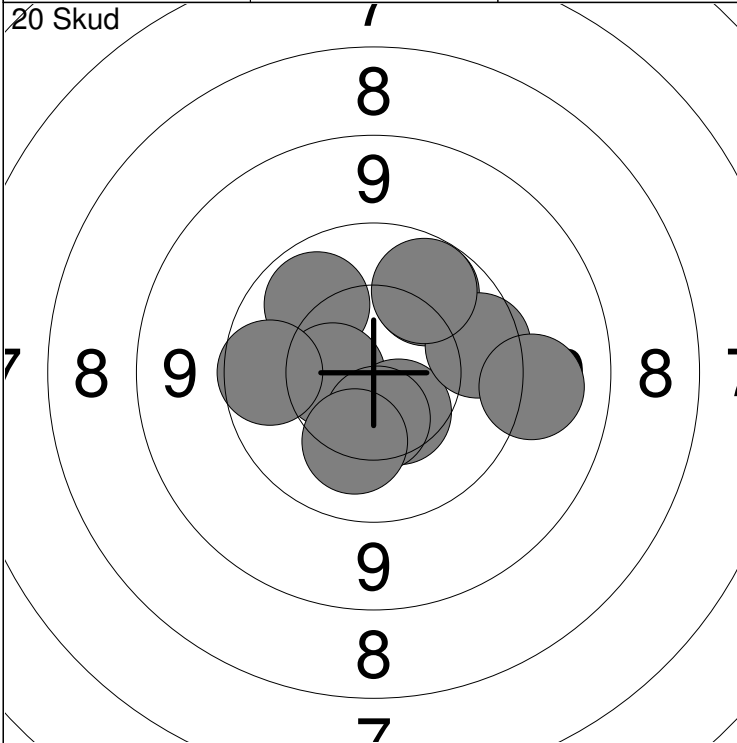

| | | | |
|-----------|-----------|-------|----|
| 1: 10.0 ↗ | 6: 10.5 ↓ | Serie | 97 |
| 2: 10.0 ↗ | 7: 10.2 ↓ | | |
| 3: 10.5 ← | 8: 9.8 → | Total | 97 |
| 4: 9.9 ← | 9: 10.0 ↑ | | |
| 5: 10.5 ↘ | 10: 9.2 → | | |

| | | | |
|------------|------------|-------|-----|
| 11: 10.3 ↑ | 16: 9.8 ↙ | Serie | 96 |
| 12: 10.2 ↗ | 17: 10.4 ↗ | | |
| 13: 10.2 → | 18: 9.3 ↗ | Total | 193 |
| 14: 10.2 ↖ | 19: 9.0 ↖ | | |
| 15: 10.5 ↑ | 20: 9.0 ← | | |

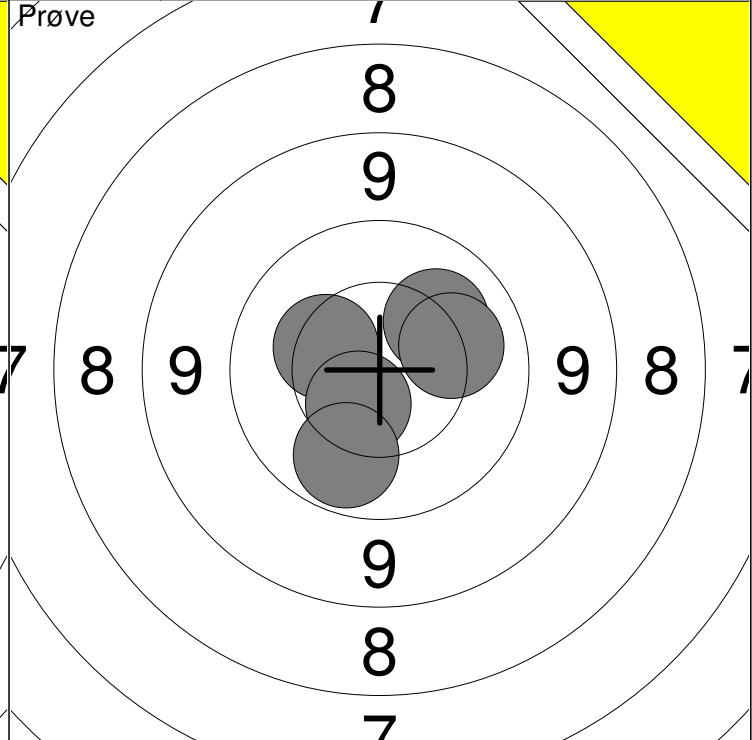
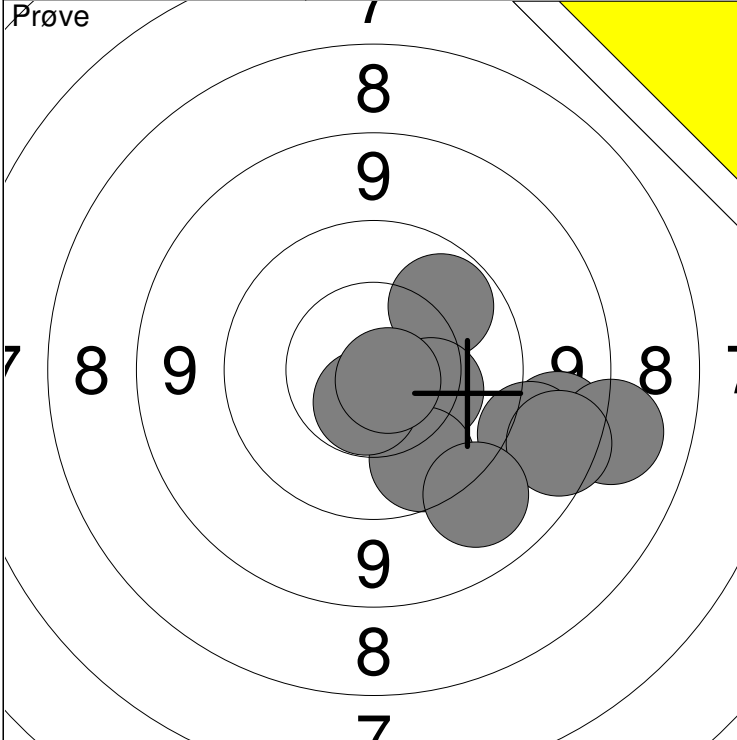

| | | |
|-----------|-------------|-------------|
| 1: 8.9 → | 6: 10.3 → | Serie 91 |
| 2: 9.1 → | 7: 9.9 ↓ | |
| 3: 8.3 → | 8: 10.6x ↓ | Total 0 |
| 4: 8.8 → | 9: 9.2 ↓ | |
| 5: 10.0 ↗ | 10: 10.8x ↓ | |

| | |
|------------|-------------|
| 11: 10.2 ↗ | Serie 50 |
| 12: 10.3 ↖ | |
| 13: 10.5 ↓ | Total 0 |
| 14: 10.0 ↓ | |
| 15: 10.2 → | |

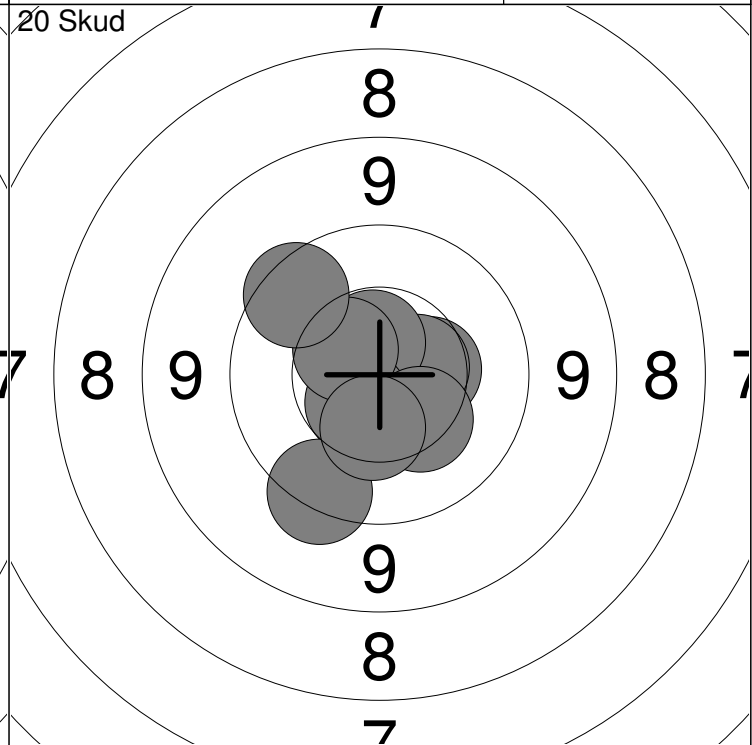
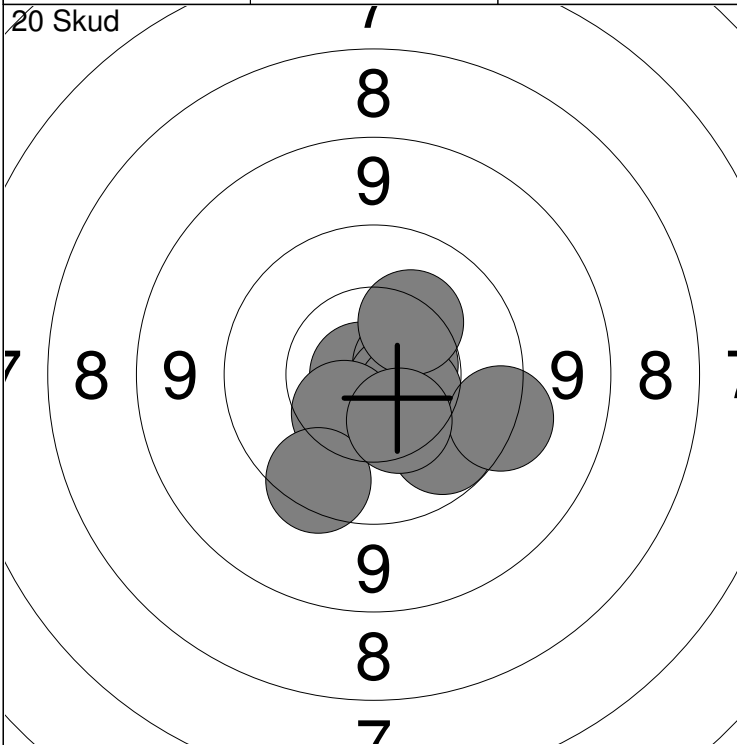

| | | |
|------------|------------|-------------|
| 1: 10.8x ← | 6: 10.4 ↓ | Serie 98 |
| 2: 10.6x → | 7: 9.7 ↓ | |
| 3: 10.0 ↓ | 8: 10.3 ↗ | Total 98 |
| 4: 10.7x ↓ | 9: 9.5 → | |
| 5: 10.5 ↓ | 10: 10.4 ↓ | |

| | | |
|-------------|------------|--------------|
| 11: 10.4 → | 16: 9.6 ↓ | Serie 98 |
| 12: 10.6x ↓ | 17: 10.3 ↓ | |
| 13: 10.6 → | 18: 10.5 ↗ | Total 196 |
| 14: 10.6x ↑ | 19: 9.7 ↗ | |
| 15: 10.6 ↓ | 20: 10.4 ↓ | |

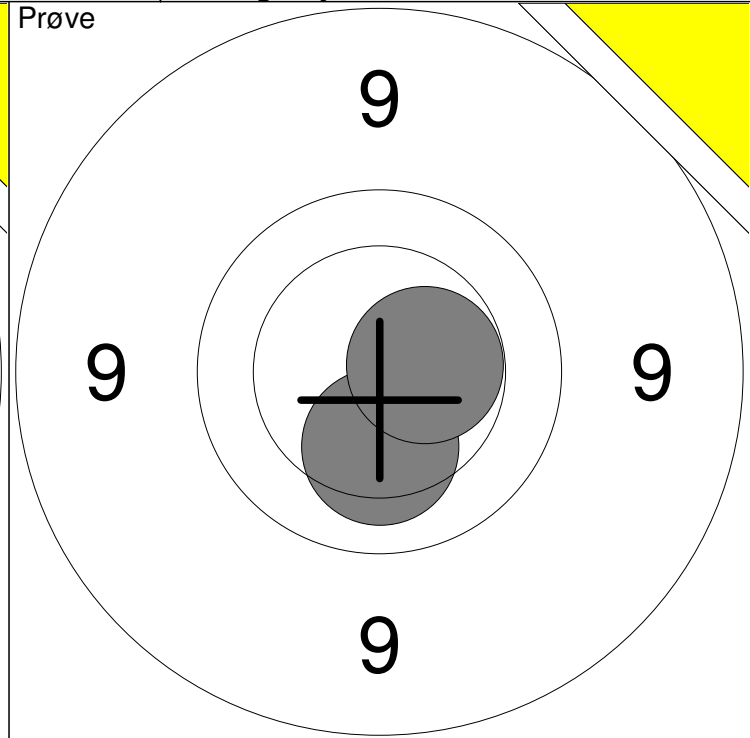
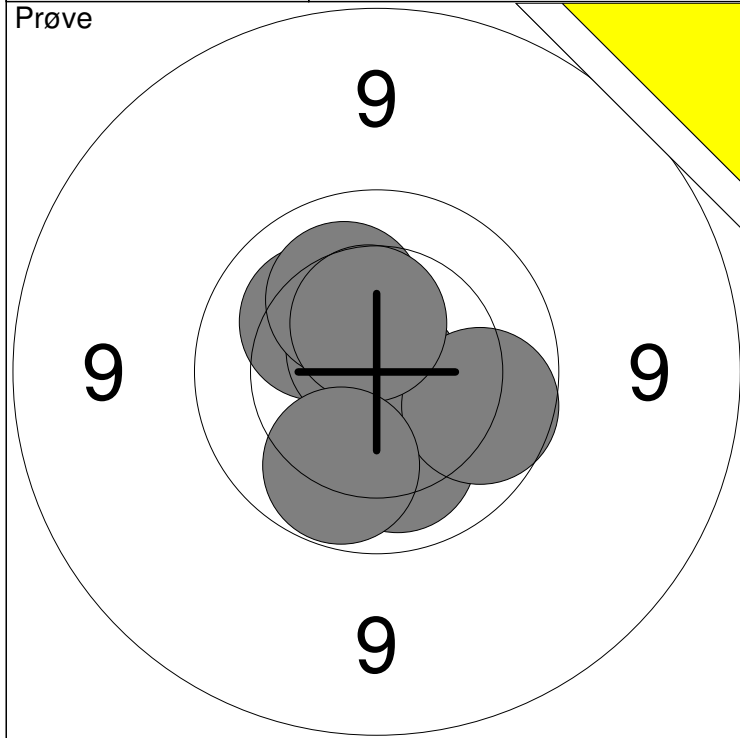

| | | | |
|------------|------------|-------|----|
| 1: 10.8x ↘ | 6: 10.2 ↗ | Serie | 99 |
| 2: 10.6x ↗ | 7: 10.1 ↘ | | |
| 3: 10.5 ↗ | 8: 9.9 → | Total | 0 |
| 4: 10.2 ↗ | 9: 10.5 ↗ | | |
| 5: 10.7x ↗ | 10: 10.0 ↘ | | |

| | | |
|-------------|-------|----|
| 11: 10.2 ↓ | Serie | 20 |
| 12: 10.5x → | | |
| Total | | 0 |

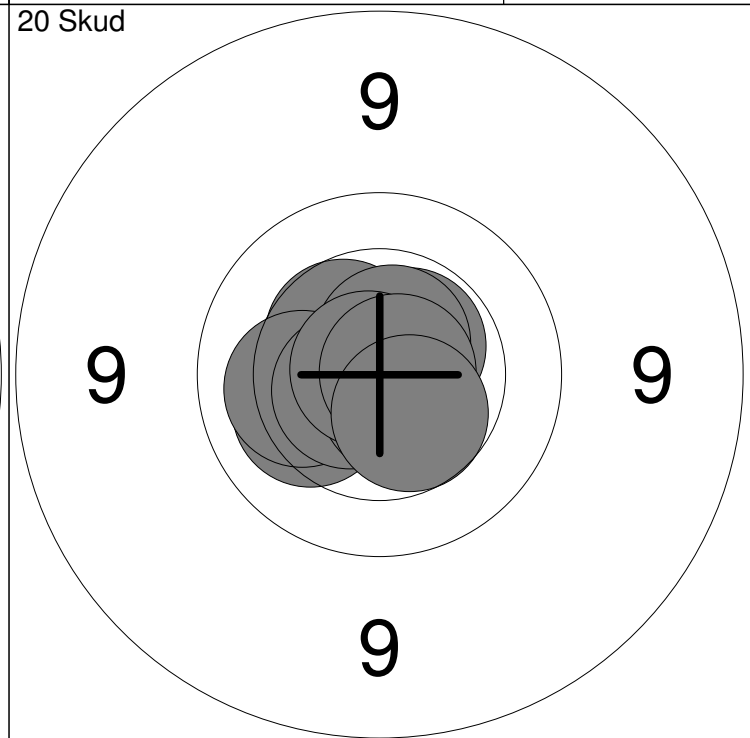
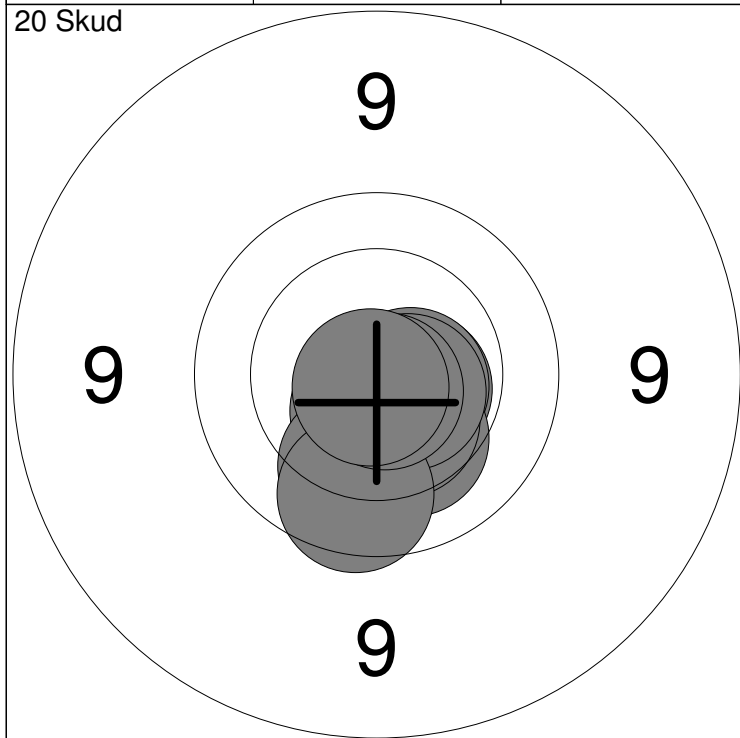

| | | | |
|------------|-------------|-------|----|
| 1: 10.6x ↓ | 6: 10.5 ↓ | Serie | 99 |
| 2: 10.6x → | 7: 10.6x ↘ | | |
| 3: 10.0 ↓ | 8: 9.9 ↓ | Total | 99 |
| 4: 10.6x → | 9: 10.8x ↓ | | |
| 5: 10.3 ↓ | 10: 10.8x ↓ | | |

| | | | |
|-------------|-------------|-------|-----|
| 11: 10.5 ↗ | 16: 10.7x ↓ | Serie | 100 |
| 12: 10.2 ↙ | 17: 10.6x ↗ | | |
| 13: 10.2 ← | 18: 10.8x ↙ | Total | 199 |
| 14: 10.6x ↙ | 19: 10.8x → | | |
| 15: 10.6x ↗ | 20: 10.5 ↓ | | |

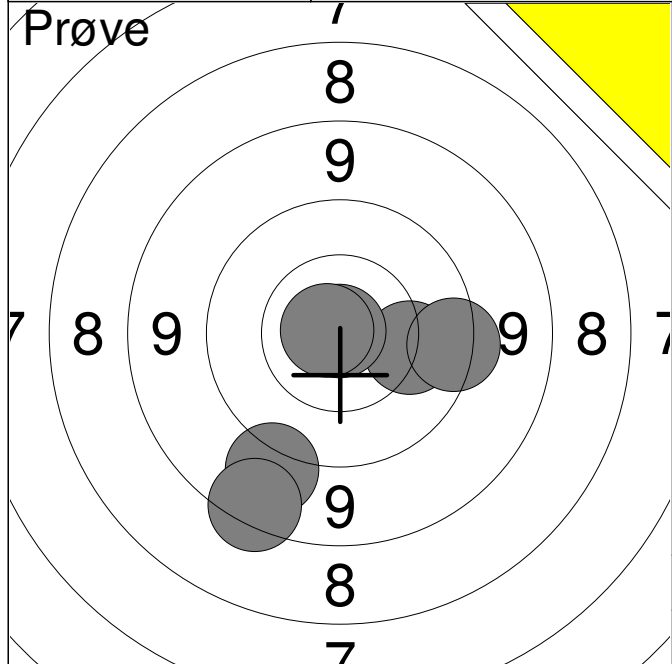

| | | |
|--------------|-------|-------------|
| 1: | 9.1 | ↙ |
| 2: | 8.6 | ↙ |
| 3: | 10.1 | → |
| 4: | 9.6 | → |
| 5: | 10.9x | ↑ |
| 6: | 10.8x | ↖ |
| Serie | | 56.0 |
| Total | | 0.0 |

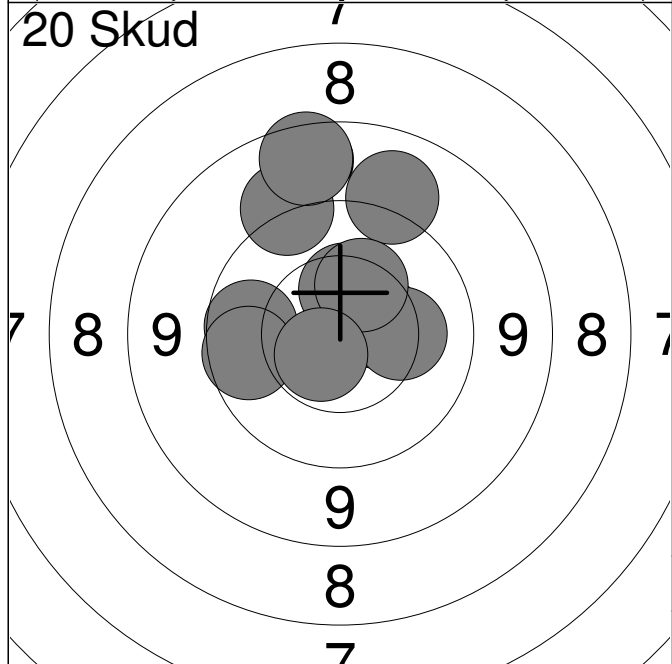

| | | |
|--------------|-------|-------------|
| 1: | 9.9 | ← |
| 2: | 9.3 | ↑ |
| 3: | 9.9 | ← |
| 4: | 10.5 | → |
| 5: | 9.2 | ↑ |
| 6: | 10.4 | ↑ |
| 7: | 10.2 | → |
| 8: | 8.8 | ↑ |
| 9: | 10.3 | ↑ |
| 10: | 10.6x | ↙ |
| Serie | | 94.0 |
| Total | | 94.0 |

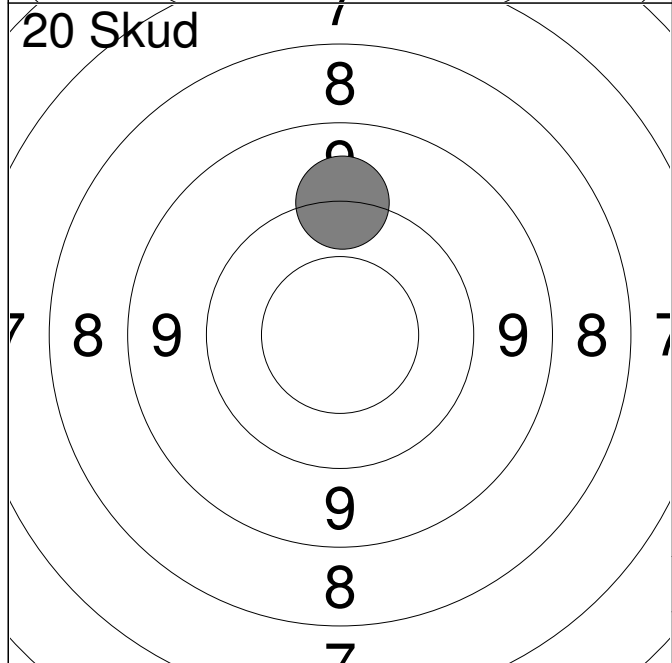

| | | |
|--------------|-----|--------------|
| 11: | 9.4 | ↑ |
| Serie | | 9.0 |
| Total | | 103.0 |

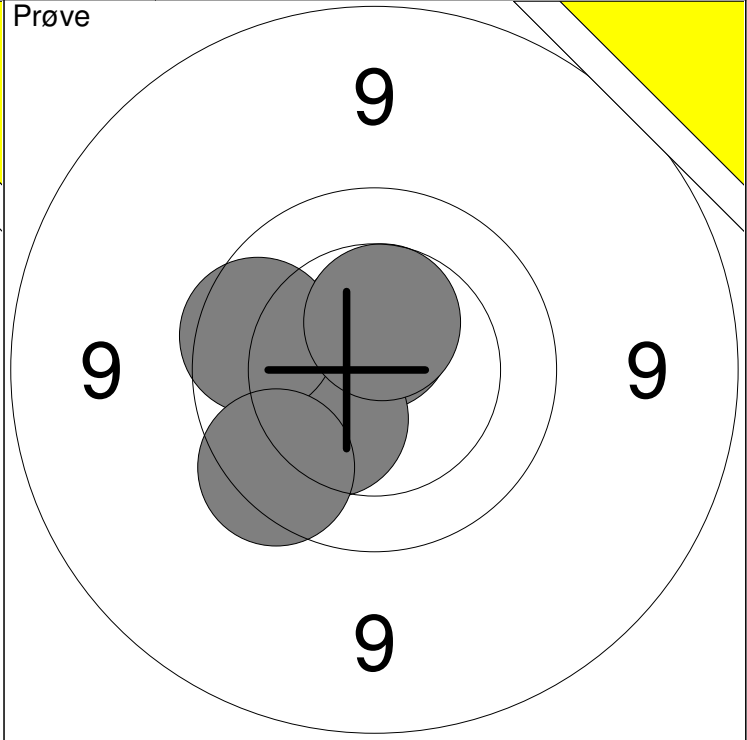
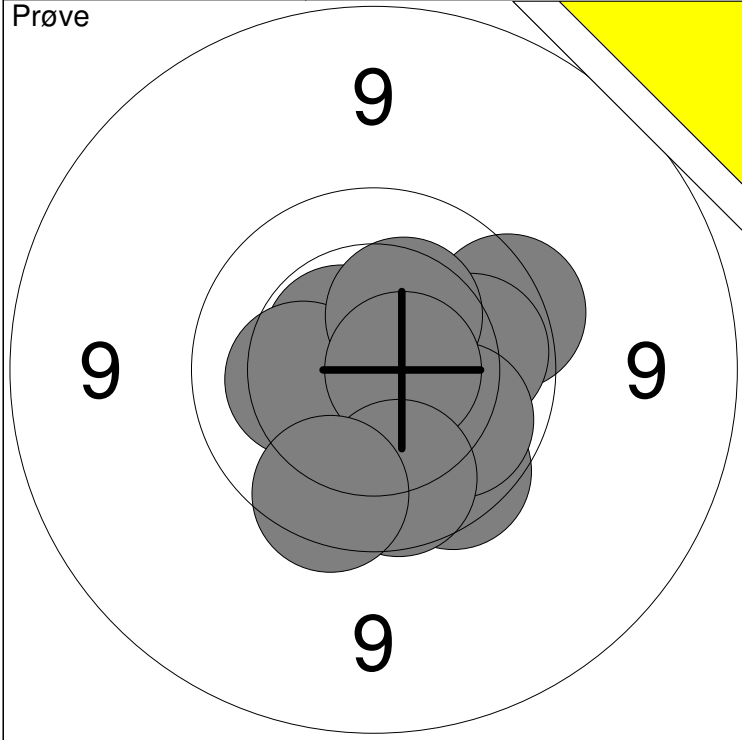

| | | | |
|------------|------------|-------|----|
| 1: 9.7 → | 6: 10.3 ← | Serie | 96 |
| 2: 10.0 → | 7: 10.3 ↗ | | |
| 3: 9.8 ↘ | 8: 10.7x → | Total | 0 |
| 4: 10.0 ↘ | 9: 9.9 ↓ | | |
| 5: 10.6x ↗ | 10: 9.8 ↓ | | |

| | | |
|-------------|-------|----|
| 11: 10.6x ↑ | Serie | 48 |
| 12: 10.3 ↘ | | |
| 13: 9.9 ← | Total | 0 |
| 14: 9.8 ↘ | | |
| 15: 10.5 ↑ | | |

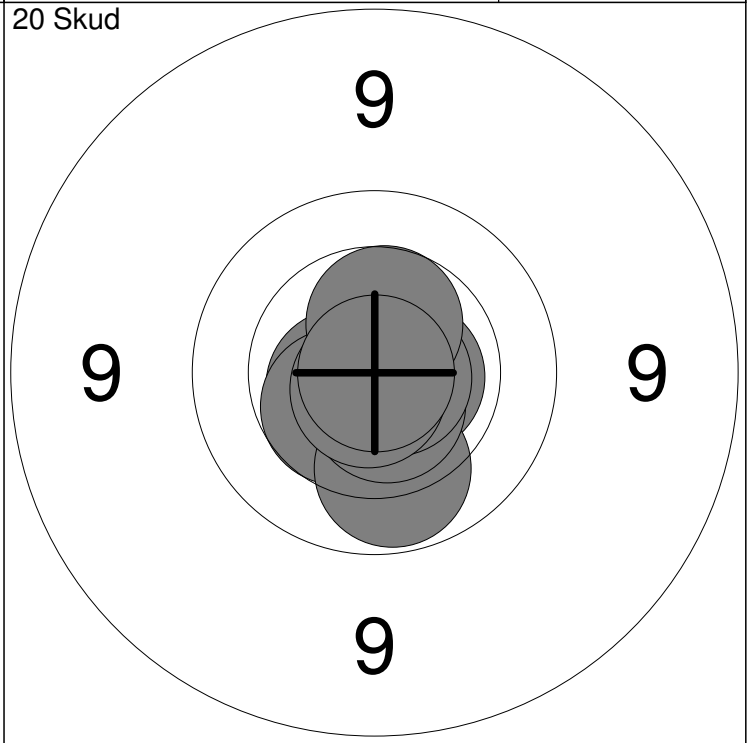
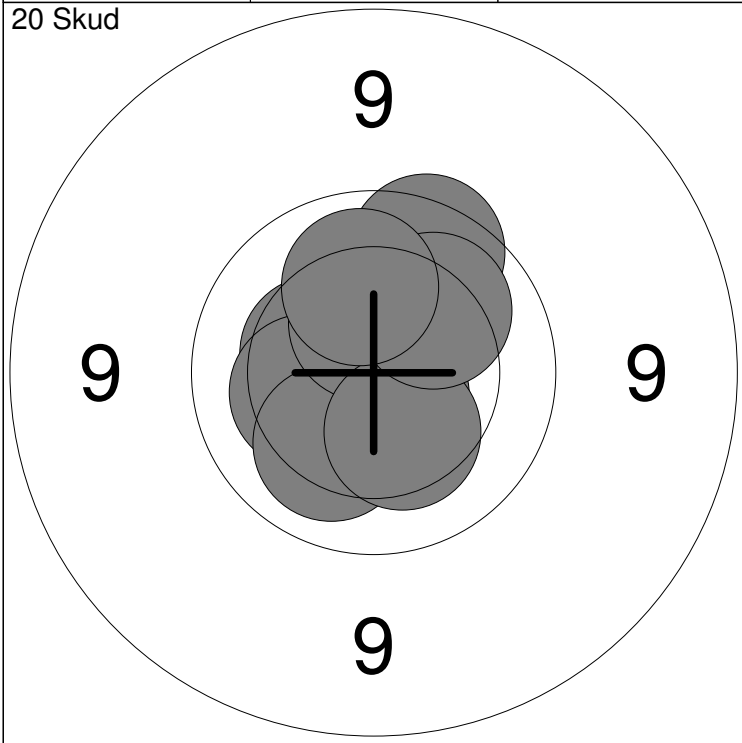

| | | | |
|------------|------------|-------|----|
| 1: 10.4 ← | 6: 10.2 ↘ | Serie | 99 |
| 2: 10.7x ↘ | 7: 10.5 ↑ | | |
| 3: 10.8x → | 8: 10.3 ↘ | Total | 99 |
| 4: 10.3 ← | 9: 10.1 ↗ | | |
| 5: 9.8 ↗ | 10: 10.1 ↑ | | |

| | | | |
|-------------|-------------|-------|-----|
| 11: 10.6x → | 16: 10.6x ↓ | Serie | 100 |
| 12: 10.6x ↘ | 17: 10.8x → | | |
| 13: 10.5 ↘ | 18: 10.5 ↑ | Total | 199 |
| 14: 10.6x ↓ | 19: 10.8x ↘ | | |
| 15: 10.0 ↓ | 20: 10.9x ↘ | | |

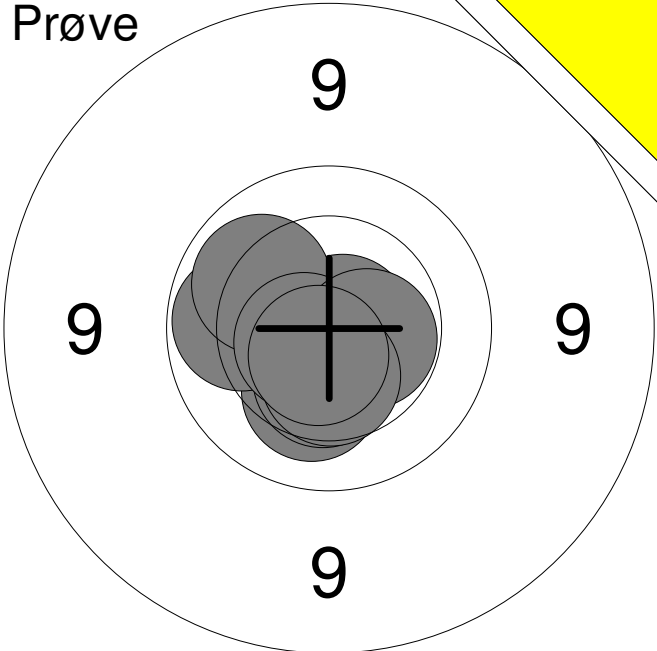
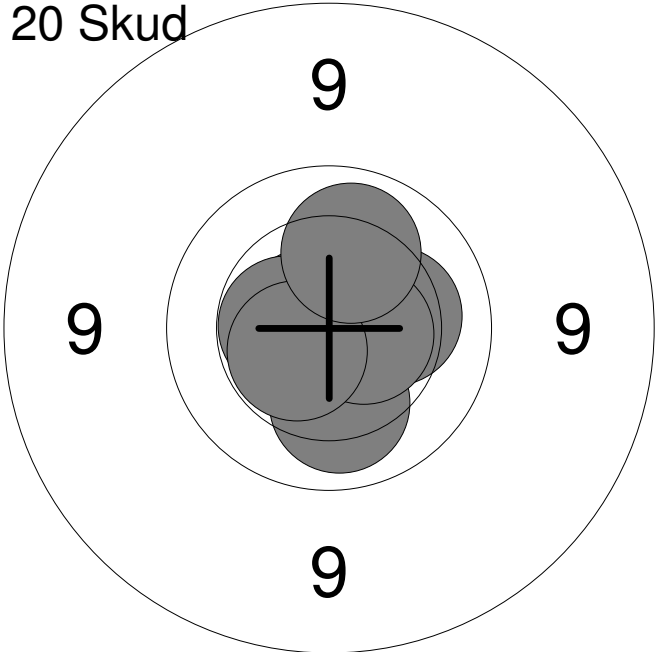
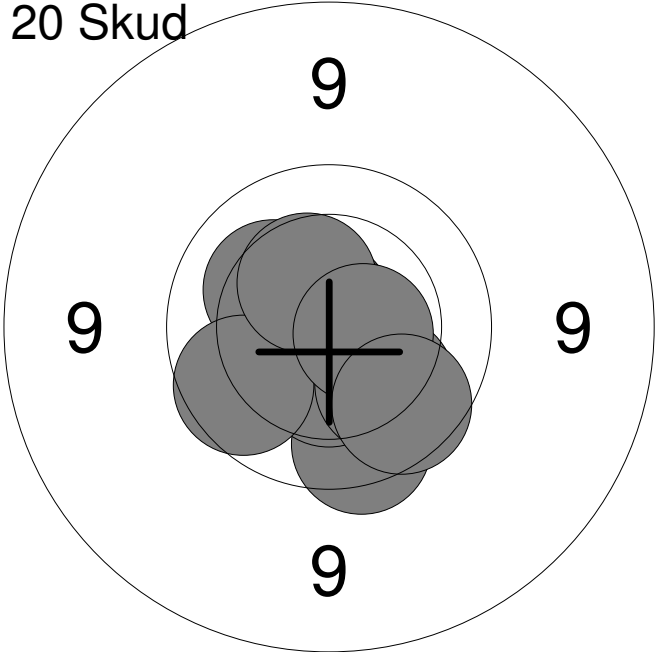
| Hold | Skive | Christine Jacobi | |
|---|---------------------------------|---------------------|-------|
| 31 | 12 | | |
| 15m | Viborg Skytteforening | MJ2 | |
| | 15 meter riffelstævne oktober 2 | Aalborg Skyttekreds | |
| Prøve  | 1: | 10.2 | ↓ |
| | 2: | 10.8x | → |
| | 3: | 10.0 | ← |
| | 4: | 10.4 | ↓ |
| | 5: | 10.5x | ↓ |
| | 6: | 10.1 | ↗ |
| | 7: | 10.6x | ← |
| | 8: | 10.5x | → |
| | 9: | 10.4 | ↓ |
| | 10: | 10.6x | ↓ |
| | Serie | | 100.0 |
| Total | | 0.0 | |
| 20 Skud  | 1: | 10.7x | ↗ |
| | 2: | 10.3 | → |
| | 3: | 10.6x | ← |
| | 4: | 10.8x | → |
| | 5: | 10.8x | ↑ |
| | 6: | 10.1 | ↓ |
| | 7: | 10.6x | → |
| | 8: | 10.5x | ← |
| | 9: | 10.5x | ↙ |
| | 10: | 10.1 | ↑ |
| | Serie | | 100.0 |
| Total | | 100.0 | |
| 20 Skud  | 11: | 10.7x | ↑ |
| | 12: | 10.8x | → |
| | 13: | 9.8 | ↓ |
| | 14: | 10.4 | ↓ |
| | 15: | 10.2 | ↗ |
| | 16: | 9.9 | ← |
| | 17: | 10.1 | ↓ |
| | 18: | 10.4 | ↗ |
| | 19: | 10.6x | → |
| | 20: | 9.9 | ↓ |
| | Serie | | 97.0 |
| Total | | 197.0 | |

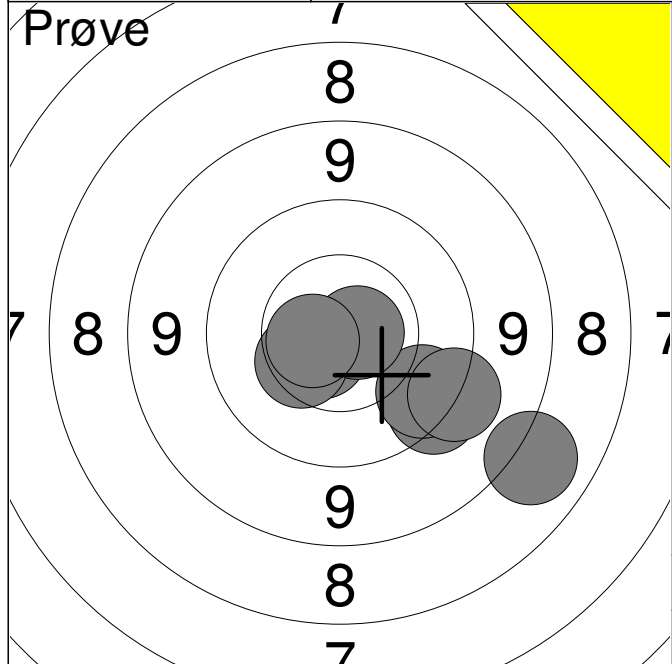

| | | |
|--------------|-------|-------------|
| 1: | 8.2 | ↘ |
| 2: | 9.5 | ↘ |
| 3: | 10.6x | ↙ |
| 4: | 9.8 | ↘ |
| 5: | 10.7x | → |
| 6: | 9.4 | ↘ |
| 7: | 10.4 | ↙ |
| 8: | 10.6x | ← |
| Serie | | 75.0 |
| Total | | 0.0 |

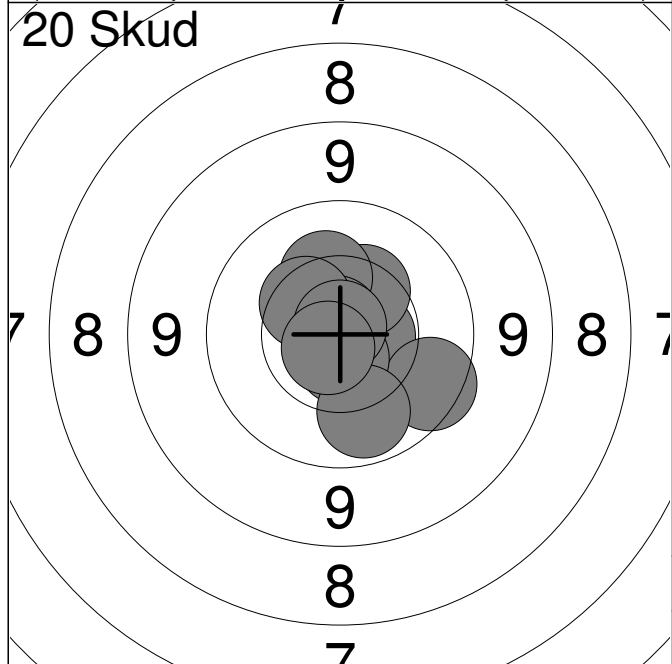

| | | |
|--------------|-------|-------------|
| 1: | 10.6x | → |
| 2: | 10.4 | ↗ |
| 3: | 9.7 | ↘ |
| 4: | 10.3 | ↗ |
| 5: | 10.7x | ↘ |
| 6: | 10.8x | ↗ |
| 7: | 10.0 | ↘ |
| 8: | 10.4 | ↗ |
| 9: | 10.9x | ↗ |
| 10: | 10.7x | ↙ |
| Serie | | 99.0 |
| Total | | 99.0 |

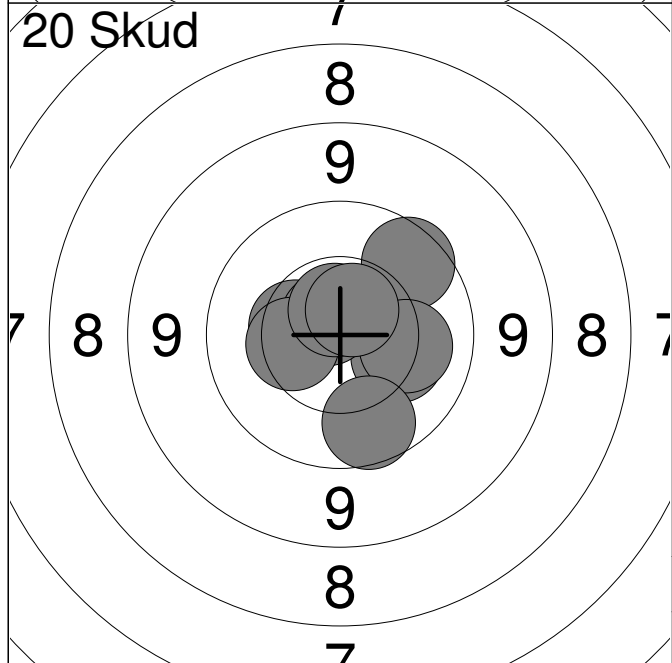

| | | |
|--------------|-------|--------------|
| 11: | 10.4 | ← |
| 12: | 10.5 | → |
| 13: | 10.2 | ↘ |
| 14: | 10.7x | ↗ |
| 15: | 9.8 | ↗ |
| 16: | 10.4 | ← |
| 17: | 10.7x | ↗ |
| 18: | 10.2 | → |
| 19: | 10.6x | ↗ |
| 20: | 9.9 | ↘ |
| Serie | | 98.0 |
| Total | | 197.0 |

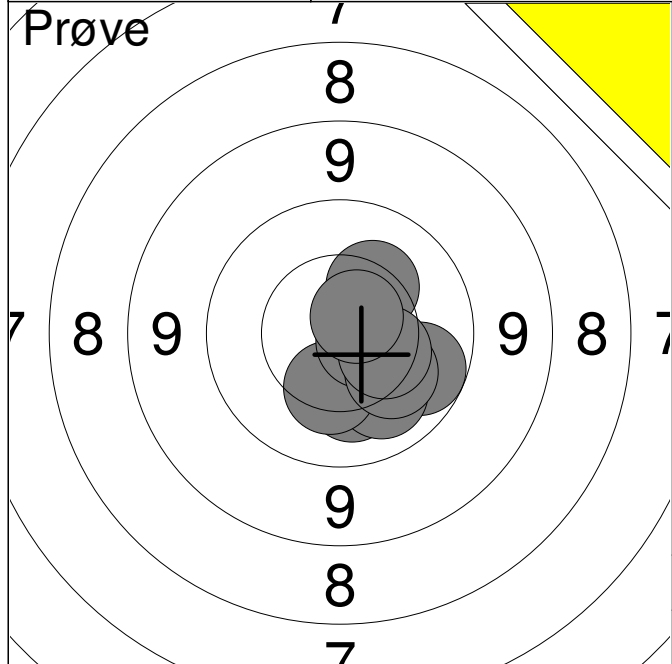

| | | |
|----|-------|---|
| 1: | 9.9 | ↘ |
| 2: | 10.2 | ↓ |
| 3: | 10.1 | ↘ |
| 4: | 10.3 | ↗ |
| 5: | 10.3 | ↓ |
| 6: | 10.7x | ↘ |
| 7: | 10.2 | ↘ |
| 8: | 10.4 | ↘ |
| 9: | 10.7x | ↗ |

| | |
|--------------|-------------|
| Serie | 89.0 |
| Total | 0.0 |

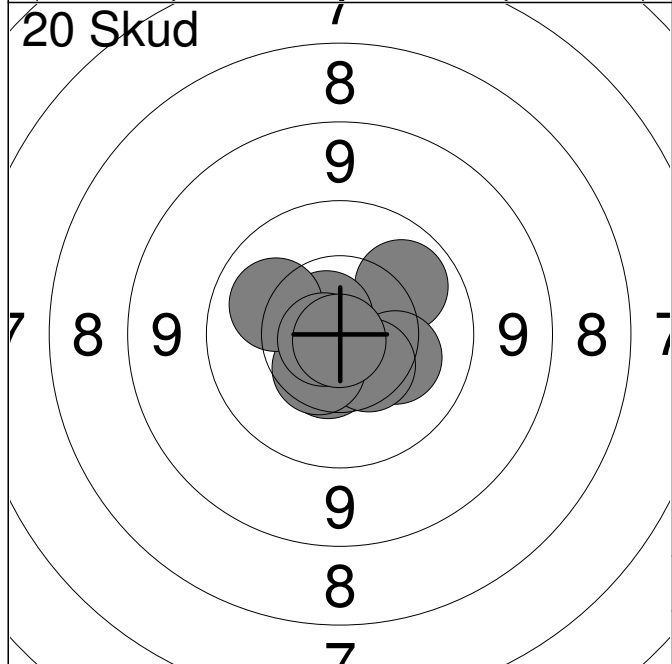

| | | |
|-----|-------|---|
| 1: | 10.7x | ↓ |
| 2: | 10.1 | ↗ |
| 3: | 10.3 | ↘ |
| 4: | 10.5 | ↓ |
| 5: | 10.7x | ↗ |
| 6: | 10.5 | ↓ |
| 7: | 10.5 | ↘ |
| 8: | 10.1 | ↗ |
| 9: | 10.8x | ← |
| 10: | 10.9x | ↓ |

| | |
|--------------|--------------|
| Serie | 100.0 |
| Total | 100.0 |

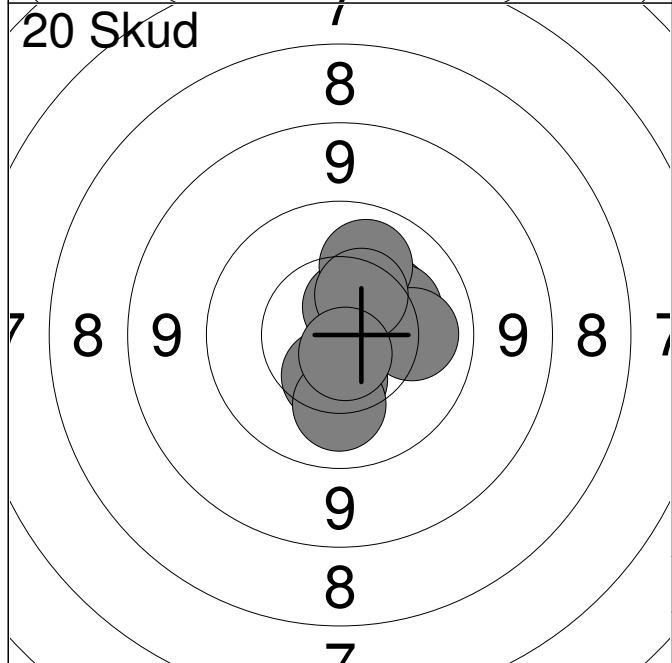

| | | |
|-----|-------|---|
| 11: | 10.3 | ↗ |
| 12: | 10.2 | → |
| 13: | 10.4 | ↓ |
| 14: | 10.1 | → |
| 15: | 10.6x | ↑ |
| 16: | 10.1 | ↑ |
| 17: | 10.5 | ↓ |
| 18: | 10.4 | ↗ |
| 19: | 10.1 | ↓ |
| 20: | 10.7x | ↓ |

| | |
|--------------|--------------|
| Serie | 100.0 |
| Total | 200.0 |

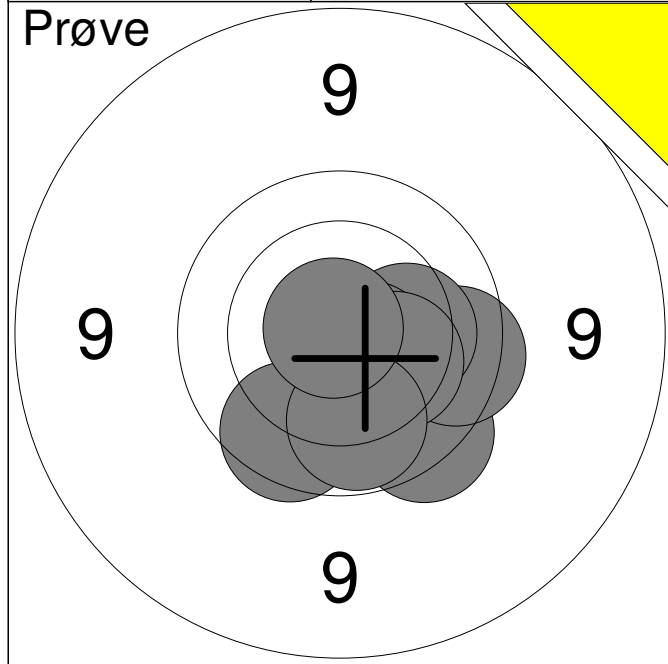

| | | |
|--------------|-------|-------------|
| 1: | 9.7 | ↘ |
| 2: | 10.6x | ↘ |
| 3: | 9.8 | → |
| 4: | 10.6x | ↘ |
| 5: | 10.2 | → |
| 6: | 9.8 | ↘ |
| 7: | 10.6x | ↘ |
| 8: | 10.3 | ↘ |
| 9: | 10.0 | ↘ |
| 10: | 10.9x | ↗ |
| Serie | | 97.0 |
| Total | | 0.0 |

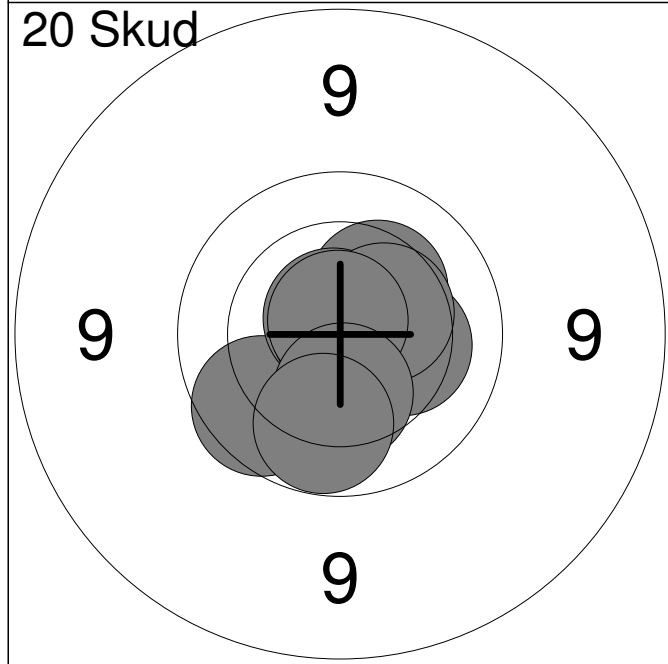

| | | |
|--------------|-------|-------------|
| 1: | 10.7x | ↗ |
| 2: | 9.9 | ↘ |
| 3: | 10.3 | → |
| 4: | 10.3 | ↗ |
| 5: | 10.8x | ↗ |
| 6: | 10.9x | ↗ |
| 7: | 10.4 | → |
| 8: | 10.8x | ↗ |
| 9: | 10.3 | ↘ |
| 10: | 10.0 | ↘ |
| Serie | | 99.0 |
| Total | | 99.0 |

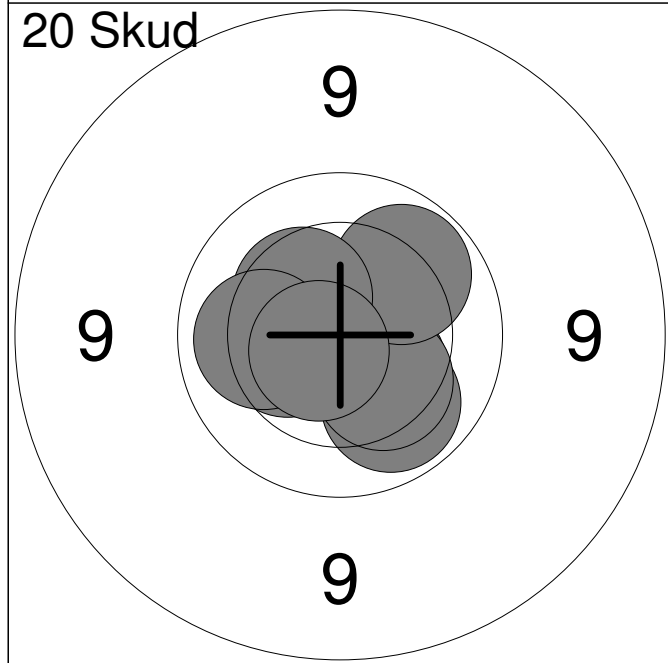

| | | |
|--------------|-------|--------------|
| 11: | 10.7x | ↖ |
| 12: | 10.4 | ↘ |
| 13: | 10.4 | ↖ |
| 14: | 10.0 | ↘ |
| 15: | 10.7x | ↘ |
| 16: | 10.3 | ↘ |
| 17: | 10.0 | ↗ |
| 18: | 10.4 | ↗ |
| 19: | 10.1 | ↖ |
| 20: | 10.7x | ↖ |
| Serie | | 100.0 |
| Total | | 199.0 |

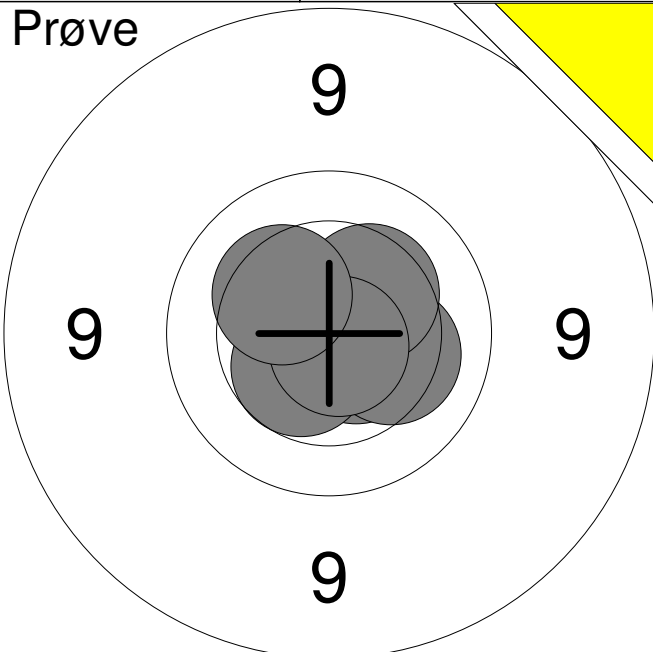
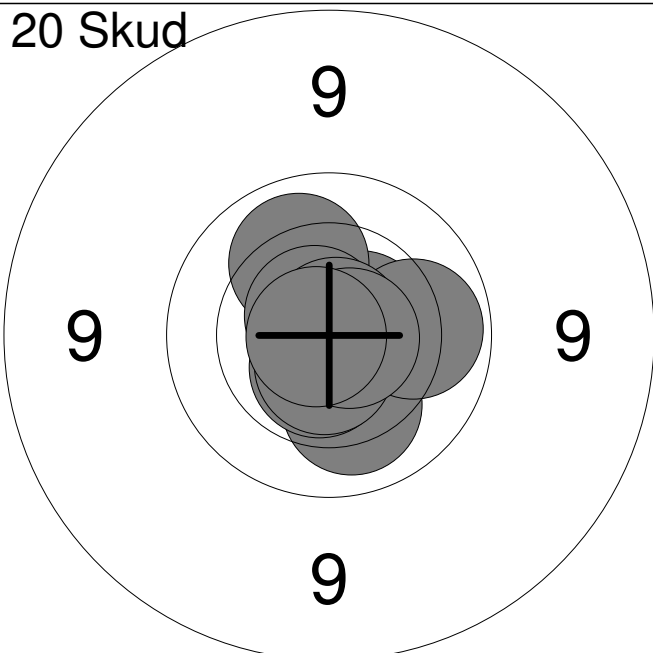
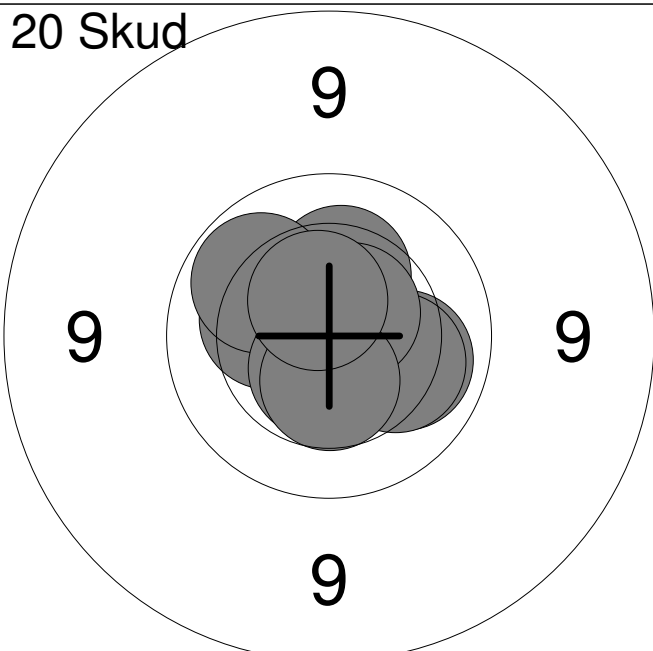
| Hold | Skive | Dirch Pedersen | |
|---------|--|---------------------|--------------|
| 32 | 4 | | |
| 15m | Løgstør Sportsskytteklub | MB1 | |
| | 15 meter riffelstævne oktober 2 | Aalborg Skyttekreds | |
| Prøve |  | 1: 10.6x → | |
| | | 2: 10.6x ↓ | |
| | | 3: 10.2 → | |
| | | 4: 10.5 ↓ | |
| | | 5: 10.3 → | |
| | | 6: 10.8x ↓ | |
| | | 7: 10.3 → | |
| | | Serie | 70.0 |
| | | Total | 0.0 |
| 20 Skud |  | 1: 10.2 ↓ | |
| | | 2: 10.6x ↓ | |
| | | 3: 10.6x → | |
| | | 4: 10.6x ↓ | |
| | | 5: 10.1 ↑ | |
| | | 6: 10.7x ↑ | |
| | | 7: 10.0 → | |
| | | 8: 10.8x ↑ | |
| | | 9: 10.7x → | |
| | | 10: 10.8x ← | |
| | | Serie | 100.0 |
| | | Total | 100.0 |
| 20 Skud |  | 11: 10.8x ↓ | |
| | | 12: 10.1 → | |
| | | 13: 10.2 → | |
| | | 14: 10.3 ↑ | |
| | | 15: 10.3 ← | |
| | | 16: 10.6x ↑ | |
| | | 17: 10.0 ↑ | |
| | | 18: 10.6x ↓ | |
| | | 19: 10.5 ↓ | |
| | | 20: 10.6x ↑ | |
| | | Serie | 100.0 |
| | | Total | 200.0 |

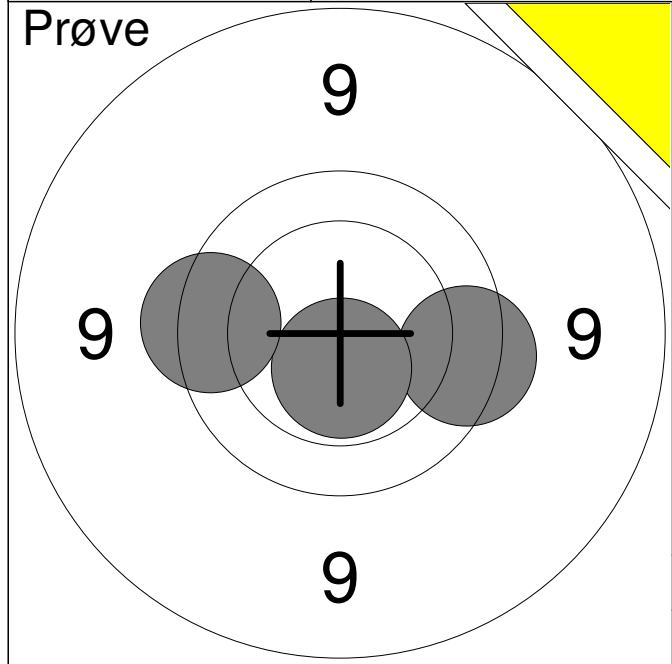

| | | |
|--------------|-------------|---|
| 1: | 9.7 | → |
| 2: | 10.6x | ↓ |
| 3: | 9.7 | ← |
| Serie | 28.0 | |
| Total | 0.0 | |

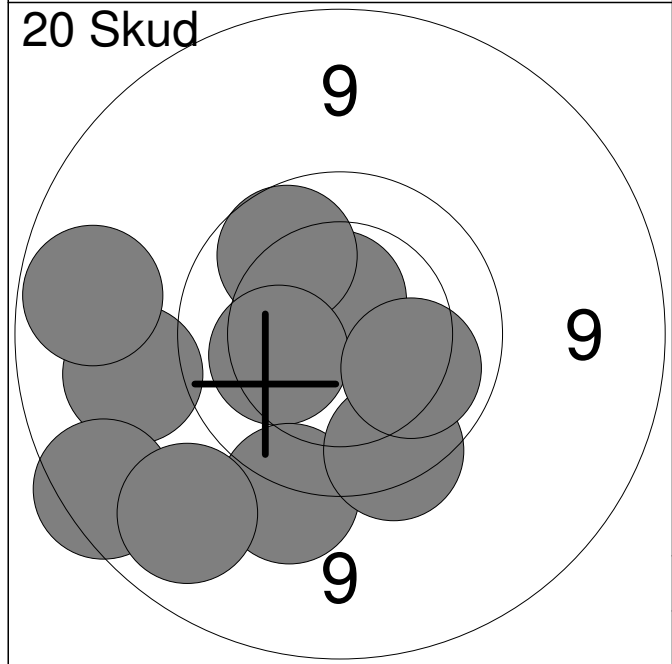

| | | |
|--------------|-------------|---|
| 1: | 10.6x | ↑ |
| 2: | 9.9 | ↗ |
| 3: | 9.2 | ← |
| 4: | 9.0 | ← |
| 5: | 8.8 | ↙ |
| 6: | 10.3 | ← |
| 7: | 9.5 | ↓ |
| 8: | 9.7 | ↓ |
| 9: | 9.1 | ↙ |
| 10: | 10.1 | → |
| Serie | 92.0 | |
| Total | 92.0 | |

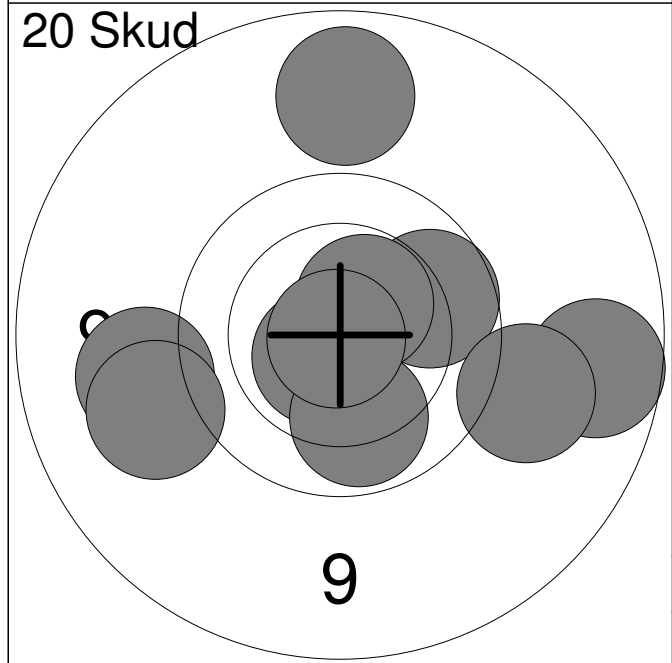

| | | |
|--------------|--------------|---|
| 11: | 10.6x | ↙ |
| 12: | 9.3 | ← |
| 13: | 10.0 | ↓ |
| 14: | 8.9 | → |
| 15: | 9.9 | ↗ |
| 16: | 9.3 | → |
| 17: | 9.3 | ↙ |
| 18: | 10.5x | ↗ |
| 19: | 9.0 | ↑ |
| 20: | 10.9x | ↙ |
| Serie | 93.0 | |
| Total | 185.0 | |

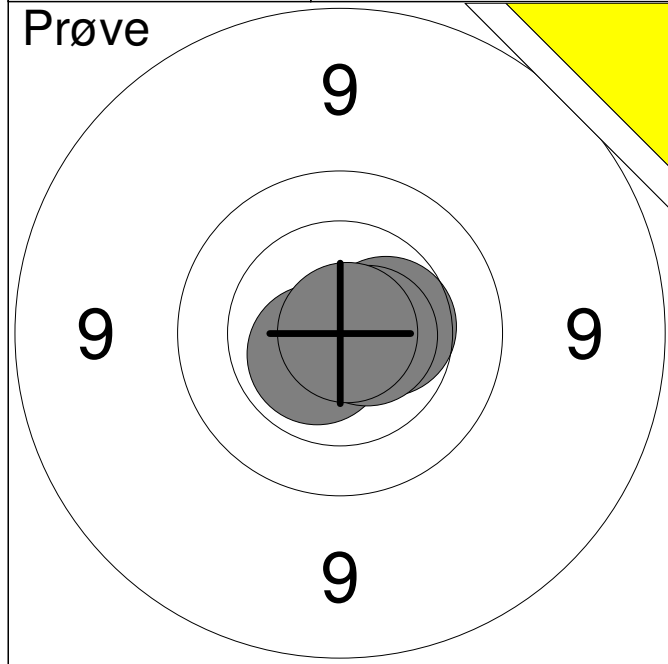

| | | |
|--------------|-------|-------------|
| 1: | 10.4 | → |
| 2: | 10.6x | ↙ |
| 3: | 10.7x | → |
| 4: | 10.9x | → |
| Serie | | 40.0 |
| Total | | 0.0 |

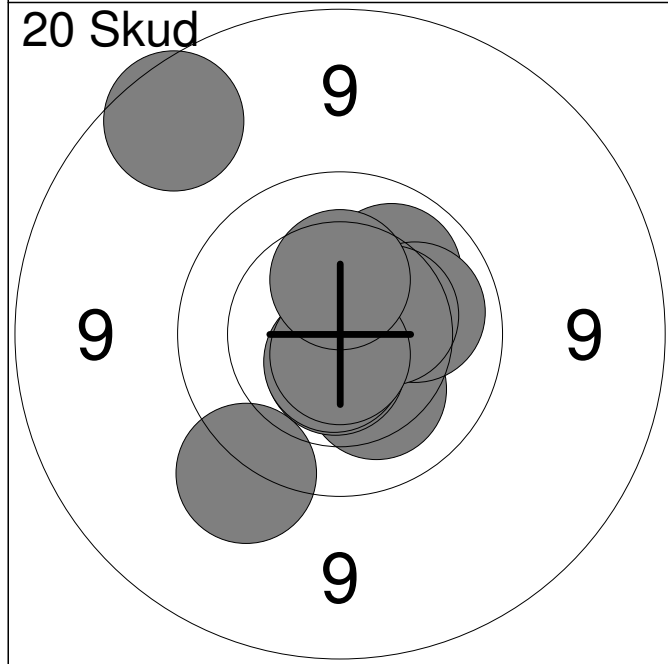

| | | |
|--------------|-------|-------------|
| 1: | 10.1 | ↗ |
| 2: | 9.5 | ↙ |
| 3: | 10.2 | ↘ |
| 4: | 10.6x | ↘ |
| 5: | 10.1 | → |
| 6: | 10.6x | ↘ |
| 7: | 10.4 | → |
| 8: | 10.7x | ↘ |
| 9: | 10.4 | ↑ |
| 10: | 8.9 | ↖ |
| Serie | | 97.0 |
| Total | | 97.0 |

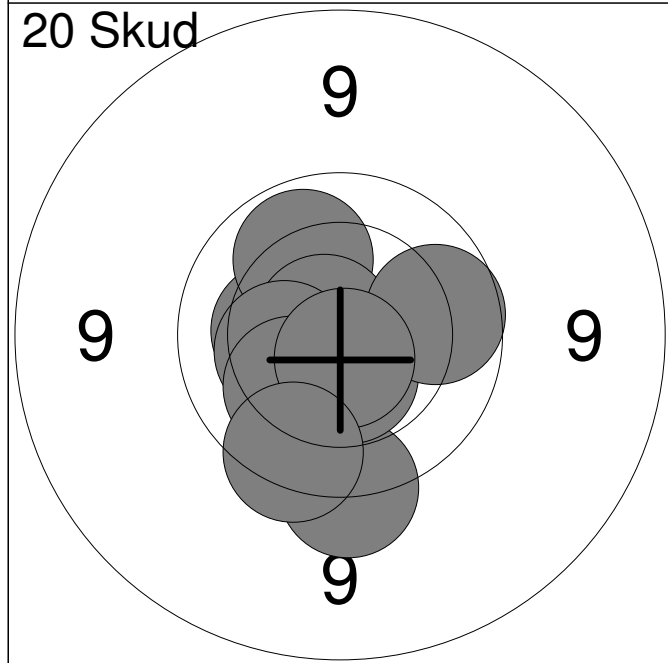

| | | |
|--------------|-------|--------------|
| 11: | 9.6 | ↘ |
| 12: | 10.3 | ← |
| 13: | 10.0 | ↗ |
| 14: | 10.7x | ↗ |
| 15: | 10.3 | ← |
| 16: | 10.2 | ↙ |
| 17: | 10.5x | ↘ |
| 18: | 9.9 | → |
| 19: | 10.7x | ↘ |
| 20: | 9.7 | ↙ |
| Serie | | 97.0 |
| Total | | 194.0 |

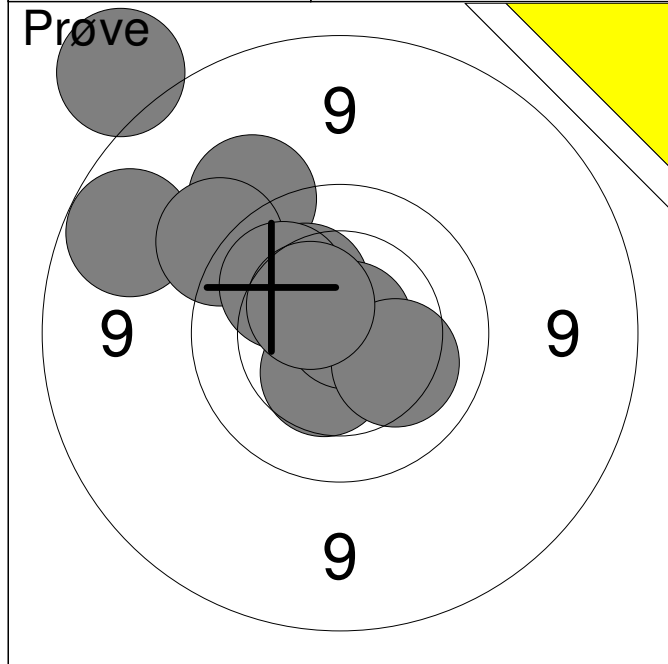

| | | |
|--------------|-------|-------------|
| 1: | 8.5 | ↗ |
| 2: | 9.0 | ↗ |
| 3: | 9.4 | ↗ |
| 4: | 9.5 | ↗ |
| 5: | 10.3 | ↗ |
| 6: | 10.1 | ↗ |
| 7: | 10.5 | ↘ |
| 8: | 10.8x | ↗ |
| 9: | 10.2 | ↘ |
| 10: | 10.5 | ↗ |
| Serie | | 95.0 |
| Total | | 0.0 |

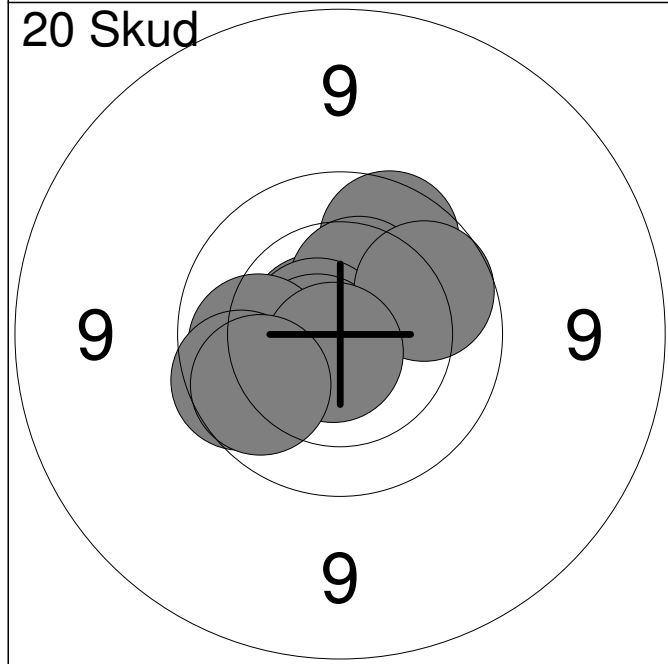

| | | |
|--------------|-------|-------------|
| 1: | 10.7x | ↖ |
| 2: | 9.9 | ↗ |
| 3: | 10.4 | ↗ |
| 4: | 10.7x | ↖ |
| 5: | 10.7x | ↖ |
| 6: | 10.1 | ↖ |
| 7: | 9.9 | ↗ |
| 8: | 9.8 | ↖ |
| 9: | 10.7x | ↘ |
| 10: | 9.9 | ↖ |
| Serie | | 96.0 |
| Total | | 96.0 |

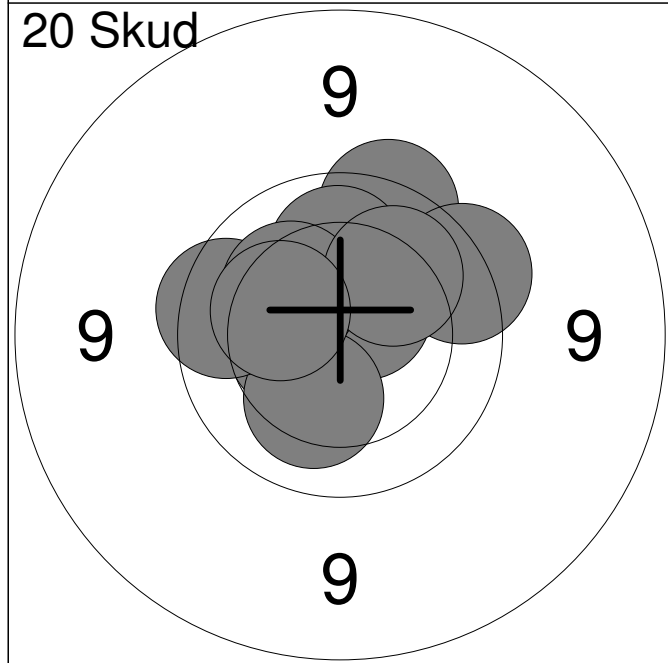

| | | |
|--------------|-------|--------------|
| 11: | 10.5 | ↖ |
| 12: | 10.6x | ↗ |
| 13: | 10.2 | ↘ |
| 14: | 9.8 | ↖ |
| 15: | 9.7 | ↗ |
| 16: | 10.1 | ↗ |
| 17: | 10.2 | ↗ |
| 18: | 9.7 | ↗ |
| 19: | 10.1 | ↗ |
| 20: | 10.3 | ↖ |
| Serie | | 97.0 |
| Total | | 193.0 |

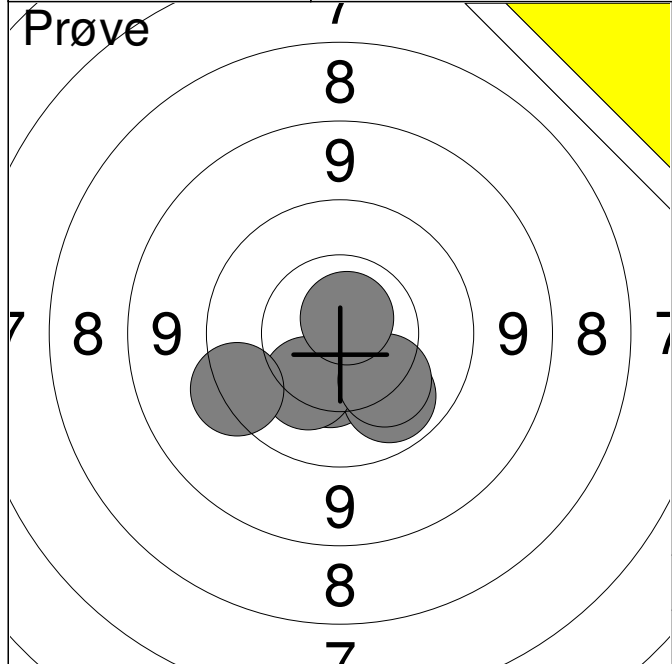

| | | |
|----|-------|---|
| 1: | 10.4 | ↓ |
| 2: | 10.0 | ↓ |
| 3: | 10.3 | ↙ |
| 4: | 10.2 | ↓ |
| 5: | 9.6 | ↙ |
| 6: | 10.8x | ↑ |

| | |
|--------------|-------------|
| Serie | 59.0 |
| Total | 0.0 |

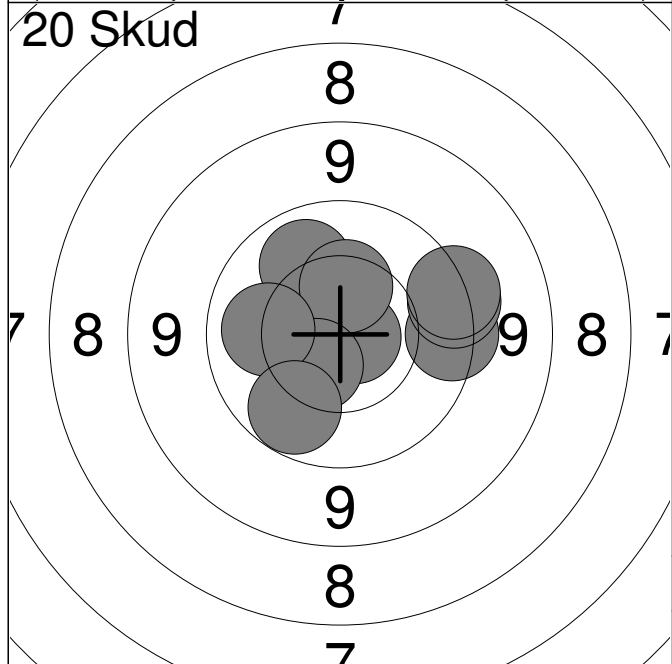

| | | |
|-----|-------|---|
| 1: | 10.8x | ↑ |
| 2: | 10.1 | ↑ |
| 3: | 9.6 | → |
| 4: | 9.5 | → |
| 5: | 10.8x | → |
| 6: | 9.5 | → |
| 7: | 10.4 | ↑ |
| 8: | 10.5 | ↙ |
| 9: | 10.1 | ← |
| 10: | 10.0 | ↙ |

| | |
|--------------|-------------|
| Serie | 97.0 |
| Total | 97.0 |

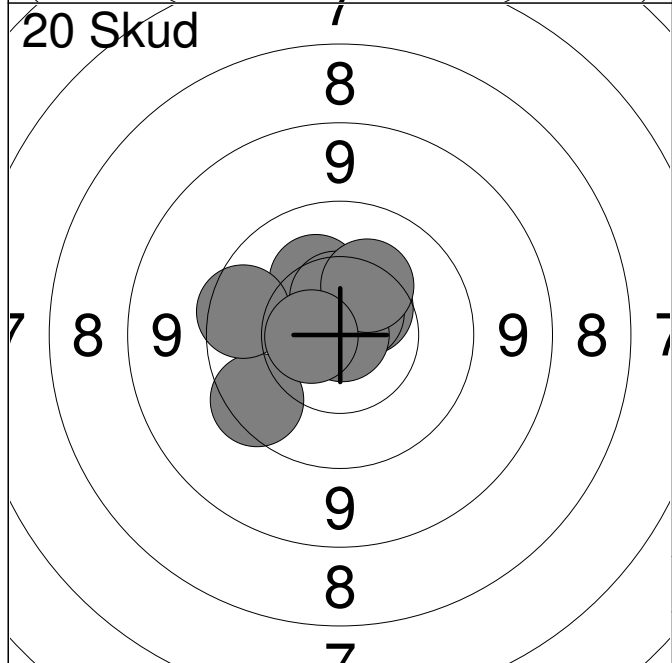

| | | |
|-----|-------|---|
| 11: | 10.5 | ↗ |
| 12: | 10.6x | ↗ |
| 13: | 9.7 | ↙ |
| 14: | 10.7x | ↑ |
| 15: | 10.3 | ↑ |
| 16: | 10.5 | ↑ |
| 17: | 9.8 | ← |
| 18: | 10.9x | → |
| 19: | 10.3 | ↗ |
| 20: | 10.6x | ← |

| | |
|--------------|--------------|
| Serie | 98.0 |
| Total | 195.0 |

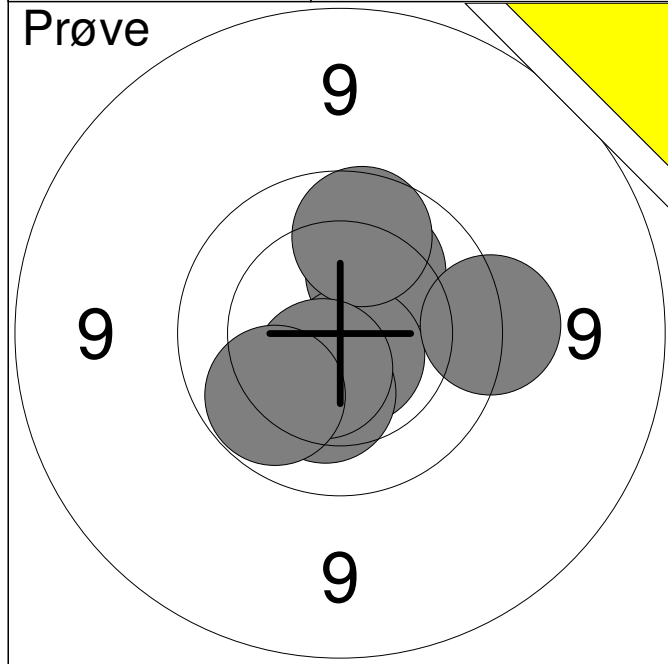

| | | |
|--------------|-------------|---|
| 1: | 10.2 | ↗ |
| 2: | 10.7x | ↘ |
| 3: | 9.9 | ↗ |
| 4: | 9.6 | → |
| 5: | 10.3 | ↘ |
| 6: | 10.5x | ↘ |
| 7: | 10.0 | ↙ |
| Serie | 68.0 | |
| Total | 0.0 | |

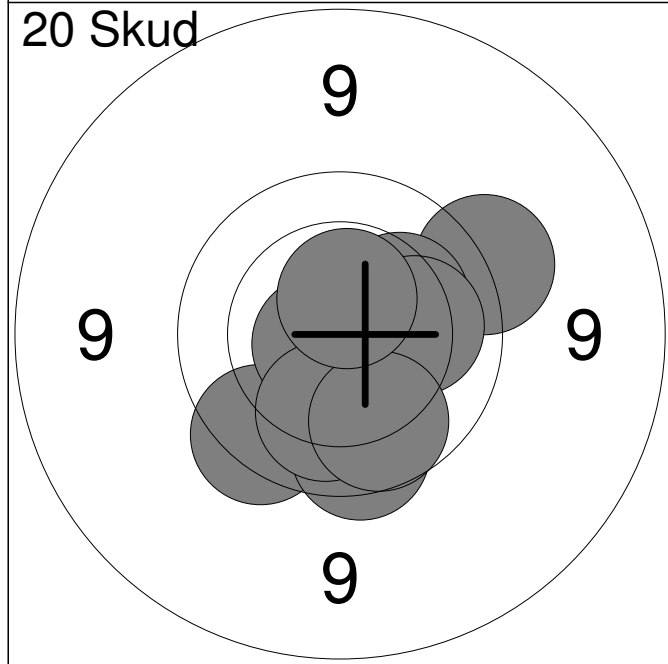

| | | |
|--------------|-------------|---|
| 1: | 9.7 | ↙ |
| 2: | 9.8 | ↘ |
| 3: | 10.5x | → |
| 4: | 9.5 | → |
| 5: | 10.7x | ↙ |
| 6: | 10.2 | ↗ |
| 7: | 10.1 | → |
| 8: | 10.1 | ↘ |
| 9: | 9.9 | ↘ |
| 10: | 10.6x | ↗ |
| Serie | 96.0 | |
| Total | 96.0 | |

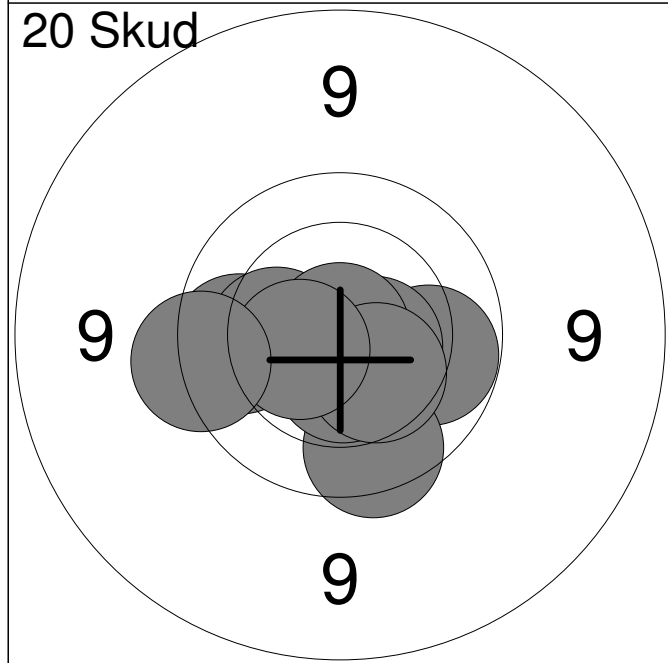

| | | |
|--------------|--------------|---|
| 11: | 9.9 | ← |
| 12: | 10.3 | ← |
| 13: | 10.0 | → |
| 14: | 10.6x | → |
| 15: | 9.8 | ↘ |
| 16: | 10.5x | ↘ |
| 17: | 10.9x | ↗ |
| 18: | 10.4 | ↘ |
| 19: | 10.5 | ↙ |
| 20: | 9.6 | ← |
| Serie | 97.0 | |
| Total | 193.0 | |

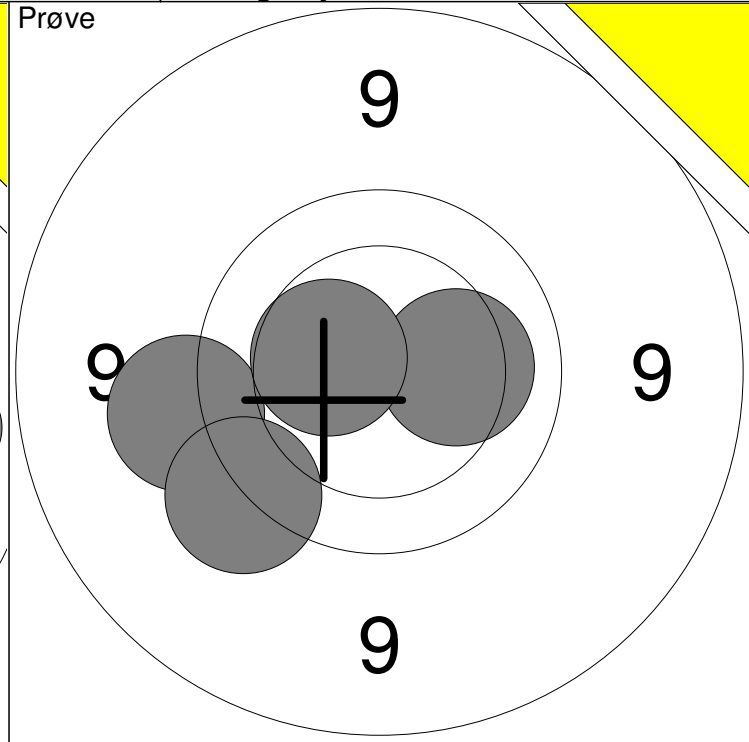
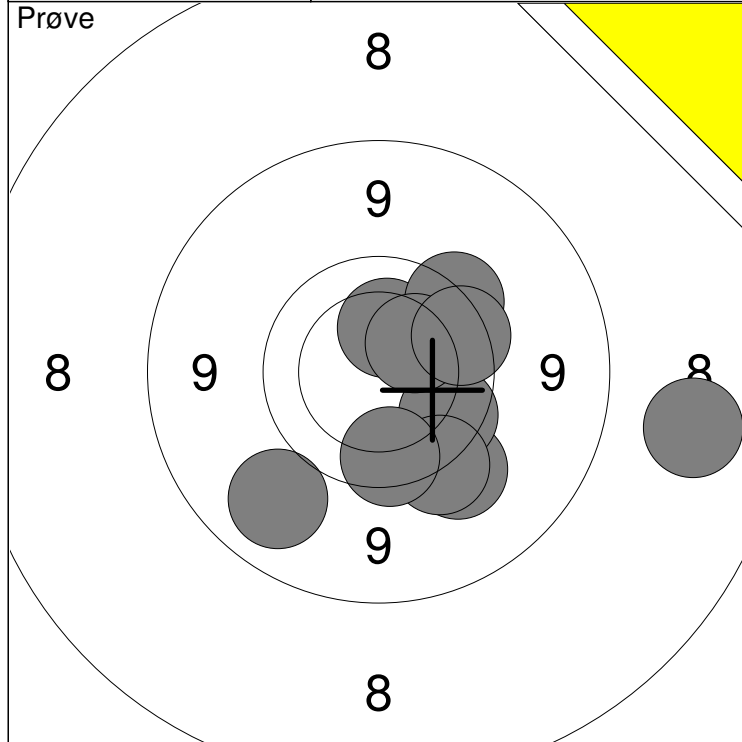

| | | |
|-----------|-----------|-----------------|
| 1: 9.4 ↘ | 6: 9.6 ↗ | Serie 91 |
| 2: 10.3 ↑ | 7: 9.1 ↘ | |
| 3: 8.2 → | 8: 9.8 ↓ | Total 0 |
| 4: 9.8 ↘ | 9: 10.2 ↗ | |
| 5: 9.6 ↘ | 10: 9.7 ↗ | |

| | |
|------------|-----------------|
| 11: 9.4 ← | Serie 38 |
| 12: 10.2 → | |
| 13: 9.5 ↘ | Total 0 |
| 14: 10.4 ← | |

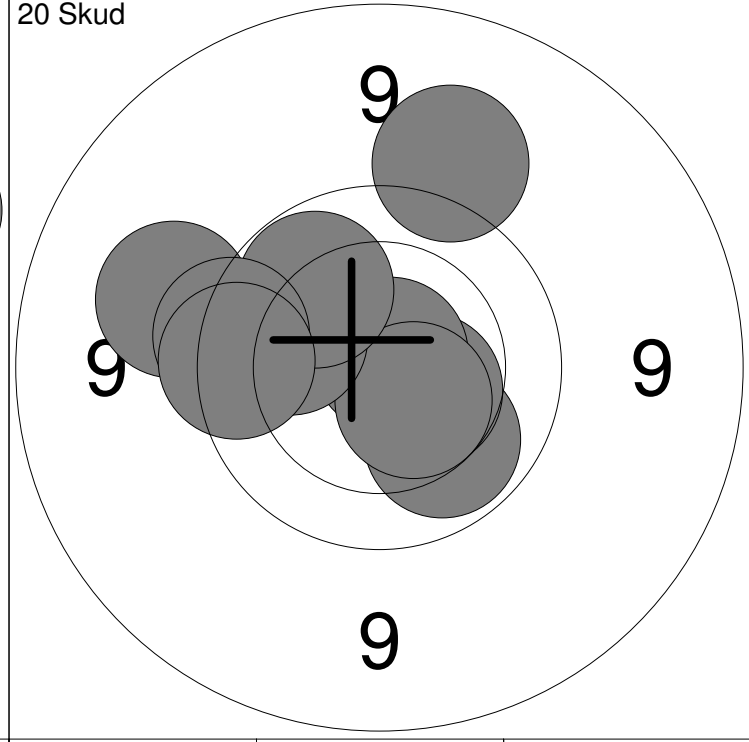
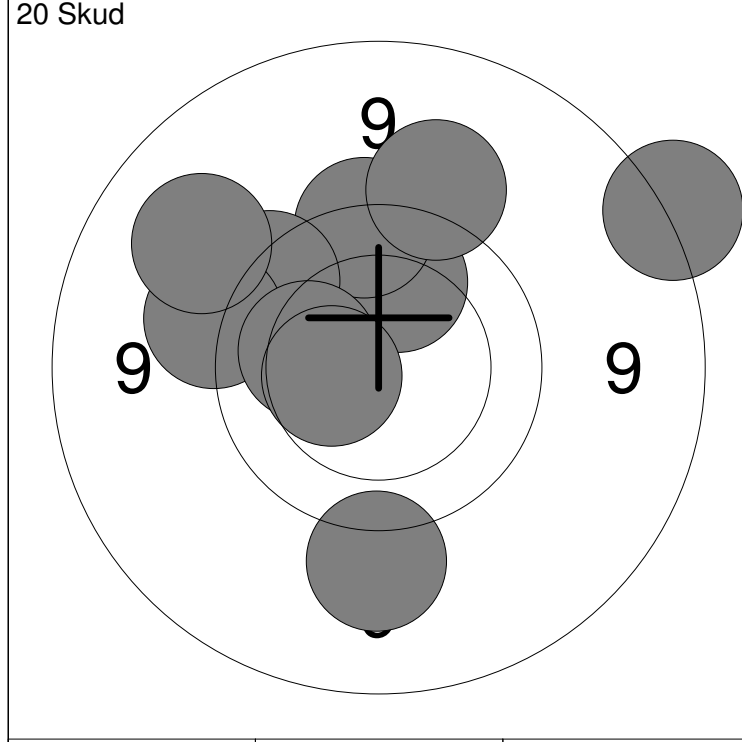

| | | |
|-----------|-----------|-----------------|
| 1: 10.0 ↑ | 6: 10.2 ← | Serie 92 |
| 2: 9.7 ↑ | 7: 10.4 ← | |
| 3: 9.7 ↗ | 8: 9.3 ↓ | Total 92 |
| 4: 9.5 ← | 9: 8.6 ↗ | |
| 5: 9.4 ↑ | 10: 9.2 ↖ | |

| | | |
|-------------|------------|------------------|
| 11: 10.0 ↘ | 16: 9.3 ← | Serie 96 |
| 12: 10.5 → | 17: 10.0 ← | |
| 13: 9.3 ↑ | 18: 10.0 ↗ | Total 188 |
| 14: 10.8x ↗ | 19: 9.7 ← | |
| 15: 10.5x ↘ | 20: 9.7 ← | |

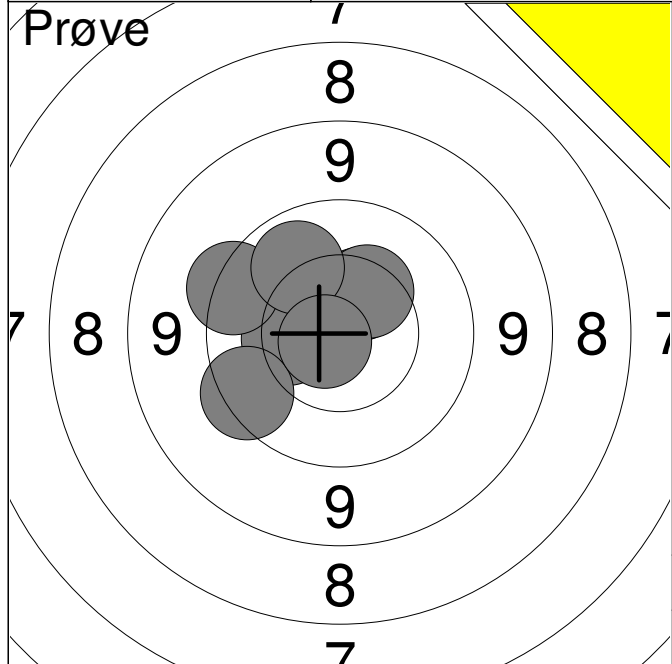

| | | |
|--------------|-------|-------------|
| 1: | 10.3 | ← |
| 2: | 9.6 | ↙ |
| 3: | 9.6 | ← |
| 4: | 10.4 | ↗ |
| 5: | 10.4 | ↗ |
| 6: | 10.0 | ↗ |
| 7: | 10.8x | ↙ |
| Serie | | 68.0 |
| Total | | 0.0 |

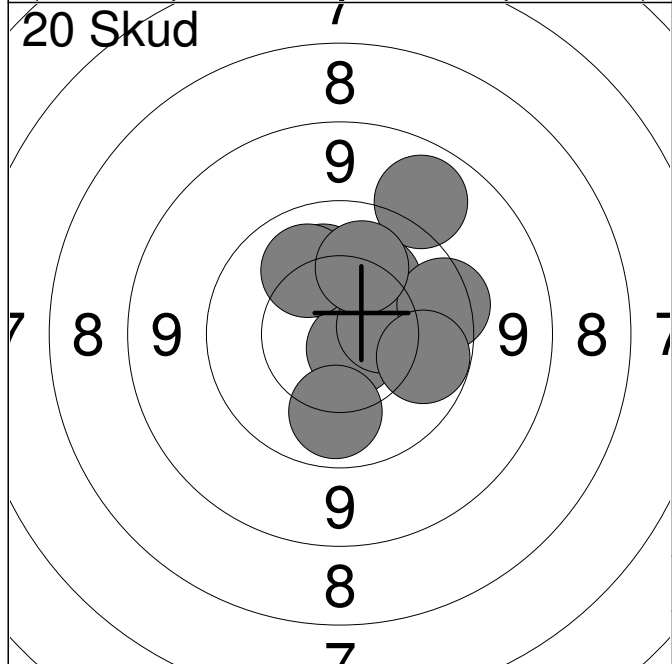

| | | |
|--------------|-------|-------------|
| 1: | 10.2 | ↖ |
| 2: | 9.1 | ↗ |
| 3: | 10.2 | ↗ |
| 4: | 10.7x | ↘ |
| 5: | 10.4 | → |
| 6: | 9.7 | → |
| 7: | 10.1 | ↖ |
| 8: | 10.0 | → |
| 9: | 10.1 | ↖ |
| 10: | 10.0 | ↘ |
| Serie | | 98.0 |
| Total | | 98.0 |

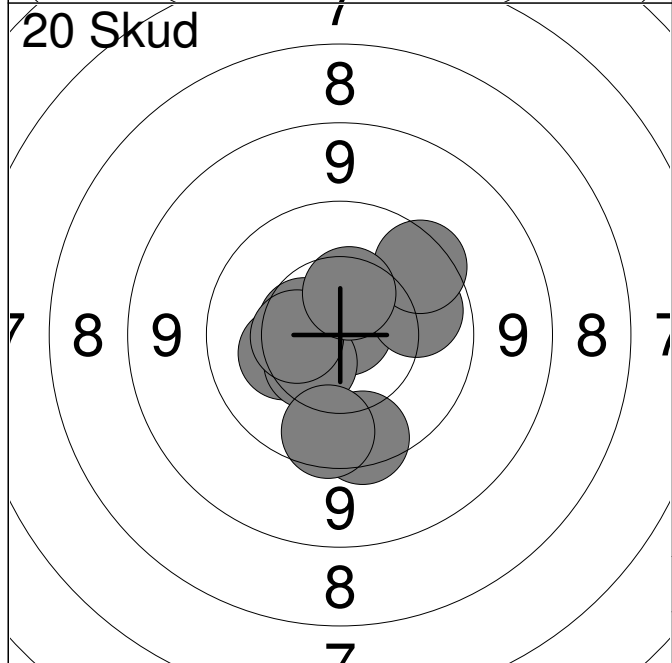

| | | |
|--------------|-------|--------------|
| 11: | 10.5 | ← |
| 12: | 10.9x | ↗ |
| 13: | 10.0 | → |
| 14: | 10.3 | ← |
| 15: | 10.5 | ↙ |
| 16: | 9.7 | ↗ |
| 17: | 10.5 | ← |
| 18: | 10.5 | ↖ |
| 19: | 9.7 | ↘ |
| 20: | 9.8 | ↘ |
| Serie | | 97.0 |
| Total | | 195.0 |

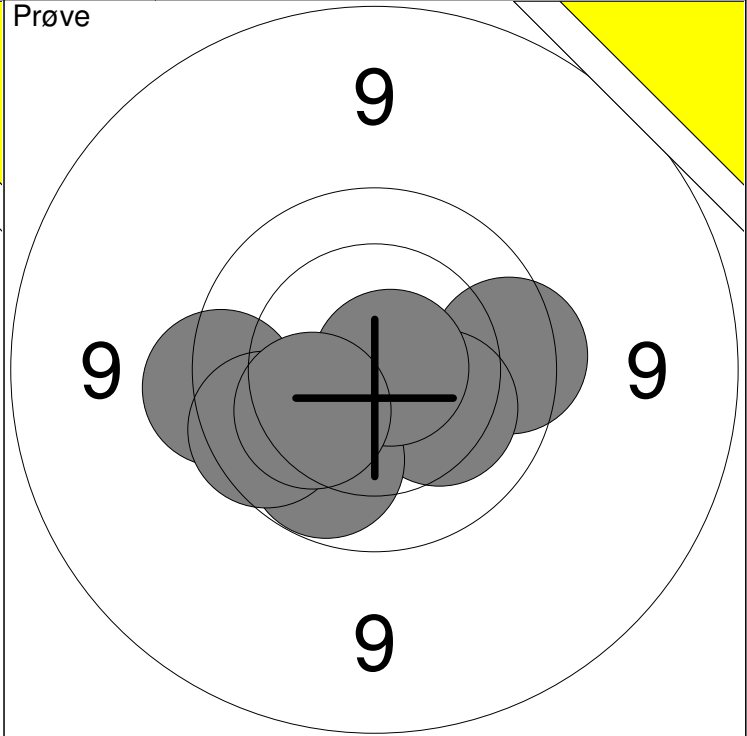
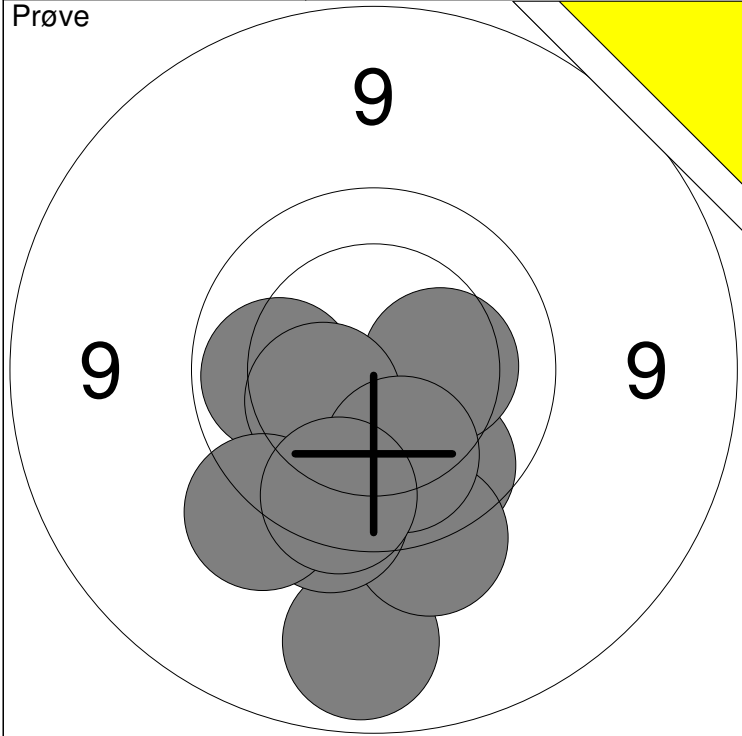

| | | | |
|-----------|-----------|-------|----|
| 1: 10.0 ← | 6: 9.5 ↓ | Serie | 94 |
| 2: 9.9 ↓ | 7: 9.7 ↓ | | |
| 3: 10.3 → | 8: 9.5 ↓ | Total | 0 |
| 4: 10.4 ← | 9: 10.1 ↓ | | |
| 5: 9.0 ↓ | 10: 9.8 ↓ | | |

| | | | |
|------------|-------------|-------|----|
| 11: 9.8 → | 16: 10.8x → | Serie | 67 |
| 12: 10.2 ↘ | 17: 10.2 ↙ | | |
| 13: 9.7 ← | | Total | 0 |
| 14: 10.0 ↓ | | | |
| 15: 9.8 ↙ | | | |

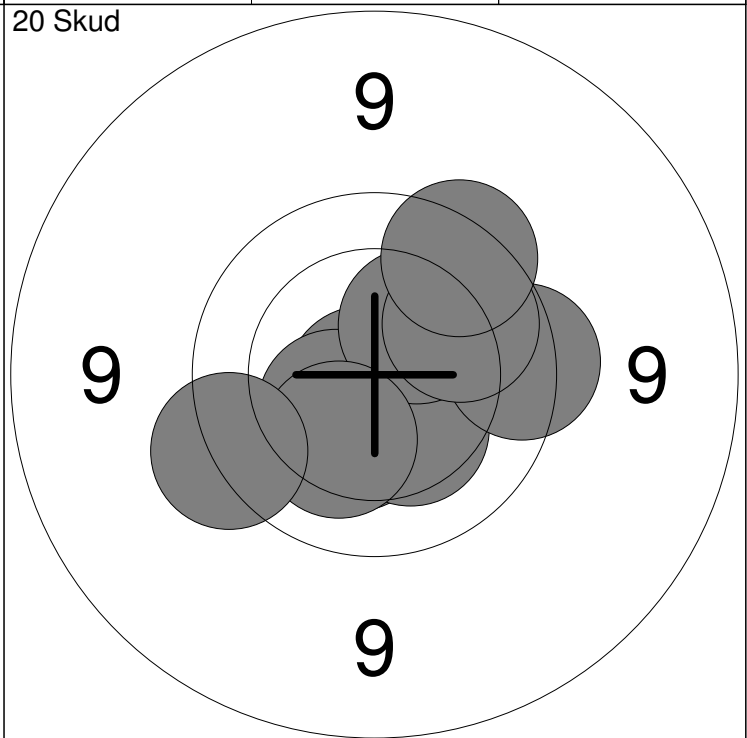
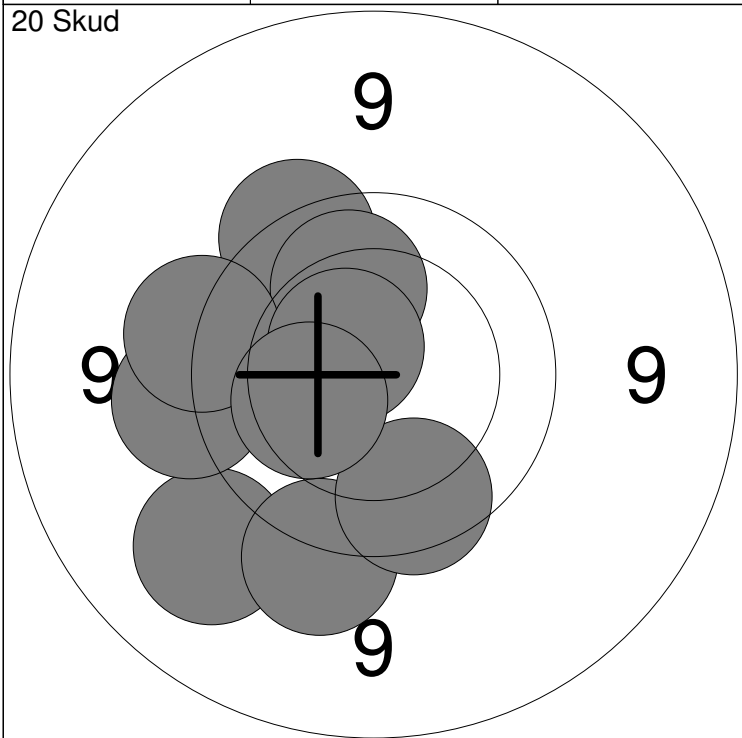

| | | | |
|-----------|------------|-------|----|
| 1: 9.2 ↙ | 6: 9.6 ← | Serie | 93 |
| 2: 9.5 ← | 7: 10.6x ↗ | | |
| 3: 9.9 ↗ | 8: 9.5 ↓ | Total | 93 |
| 4: 9.7 ↗ | 9: 9.8 ↓ | | |
| 5: 10.1 ↗ | 10: 10.3 ← | | |

| | | | |
|-------------|------------|-------|-----|
| 11: 10.8x ↙ | 16: 10.2 ↓ | Serie | 97 |
| 12: 10.4 ↓ | 17: 9.6 ↙ | | |
| 13: 10.5 ↙ | 18: 9.7 → | Total | 190 |
| 14: 10.3 ↓ | 19: 10.0 ↗ | | |
| 15: 10.3 ↗ | 20: 9.7 ↗ | | |

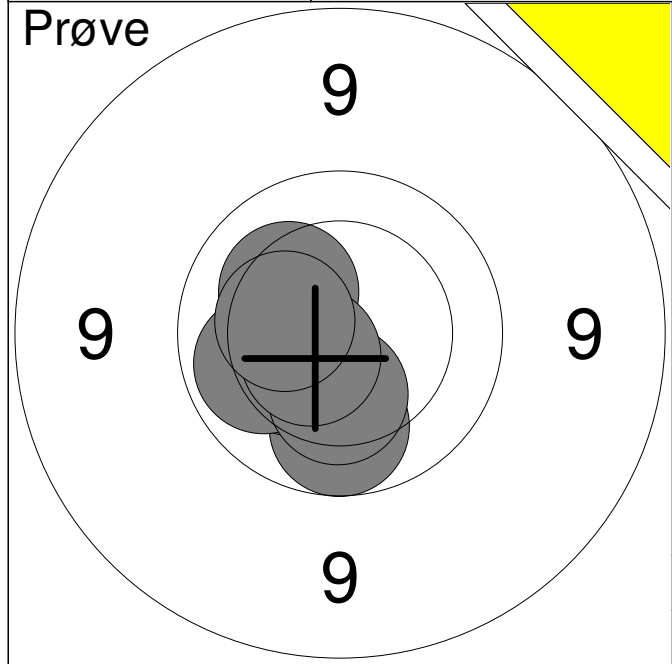

| | | |
|--------------|-------|-------------|
| 1: | 9.9 | ↓ |
| 2: | 10.3 | ↙ |
| 3: | 10.1 | ↙ |
| 4: | 10.3 | ↓ |
| 5: | 10.2 | ↗ |
| 6: | 10.5x | ↙ |
| 7: | 10.3 | ↙ |
| Serie | | 69.0 |
| Total | | 0.0 |

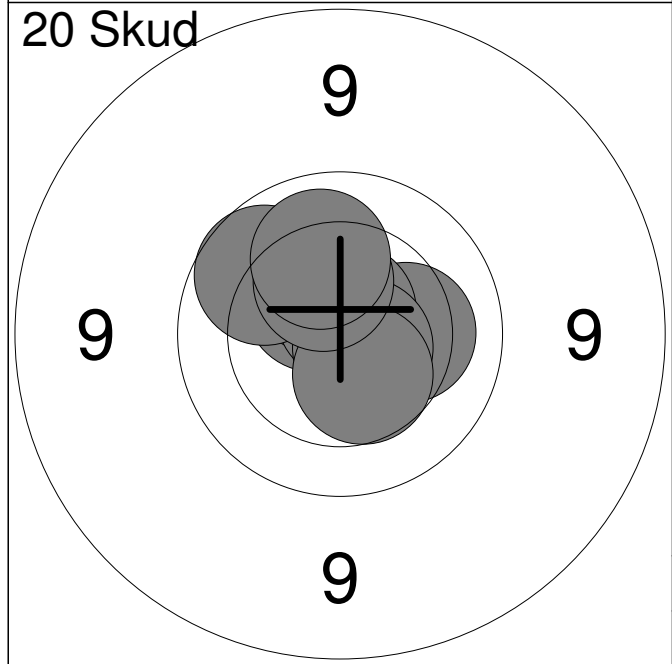

| | | |
|--------------|-------|-------------|
| 1: | 10.2 | ↗ |
| 2: | 10.2 | → |
| 3: | 10.5x | ↗ |
| 4: | 10.3 | ↗ |
| 5: | 10.7x | ↗ |
| 6: | 9.9 | ↗ |
| 7: | 10.7x | ↓ |
| 8: | 10.5 | ↓ |
| 9: | 10.4 | ↗ |
| 10: | 10.1 | ↗ |
| Serie | | 99.0 |
| Total | | 99.0 |

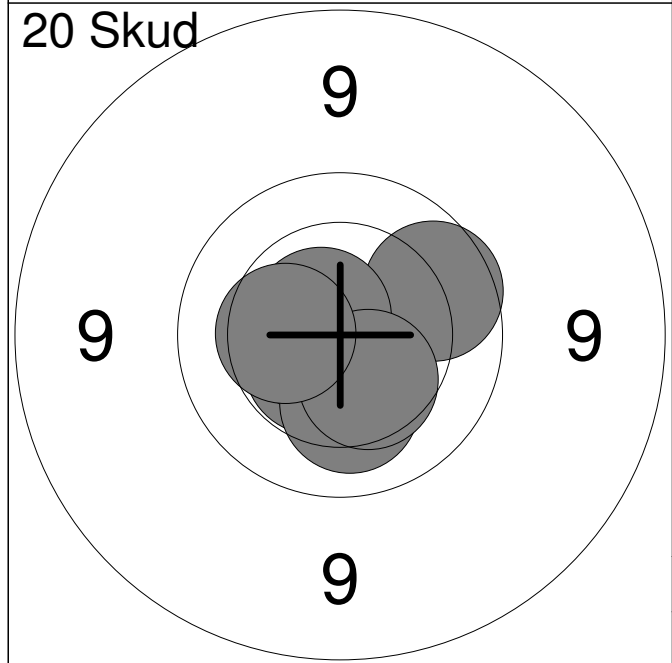

| | | |
|--------------|-------|--------------|
| 11: | 10.8x | ↗ |
| 12: | 10.6x | ↙ |
| 13: | 10.5x | ↙ |
| 14: | 10.7x | → |
| 15: | 9.9 | ↗ |
| 16: | 10.7x | ↙ |
| 17: | 10.2 | ↓ |
| 18: | 10.7x | ↗ |
| 19: | 10.4 | ↓ |
| 20: | 10.4 | ↙ |
| Serie | | 99.0 |
| Total | | 198.0 |

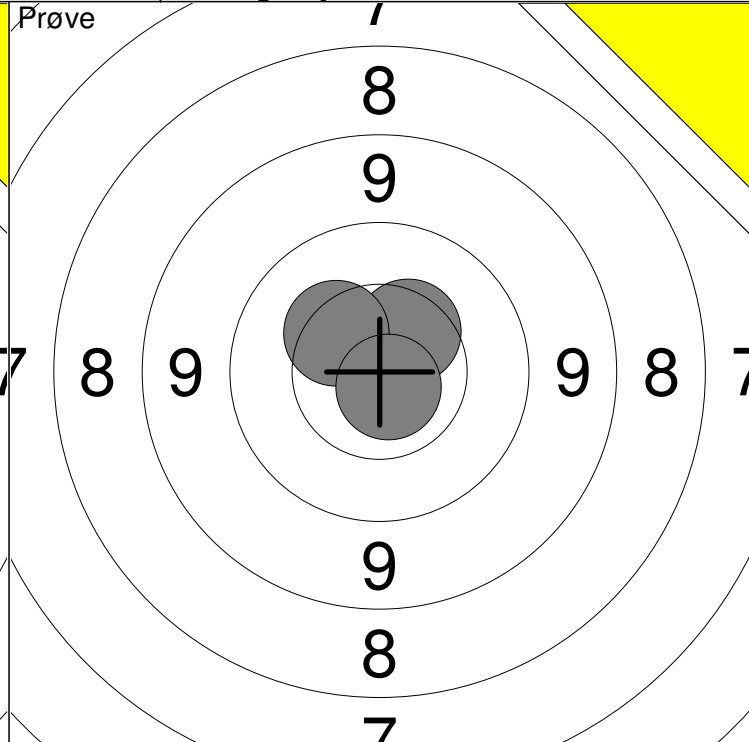
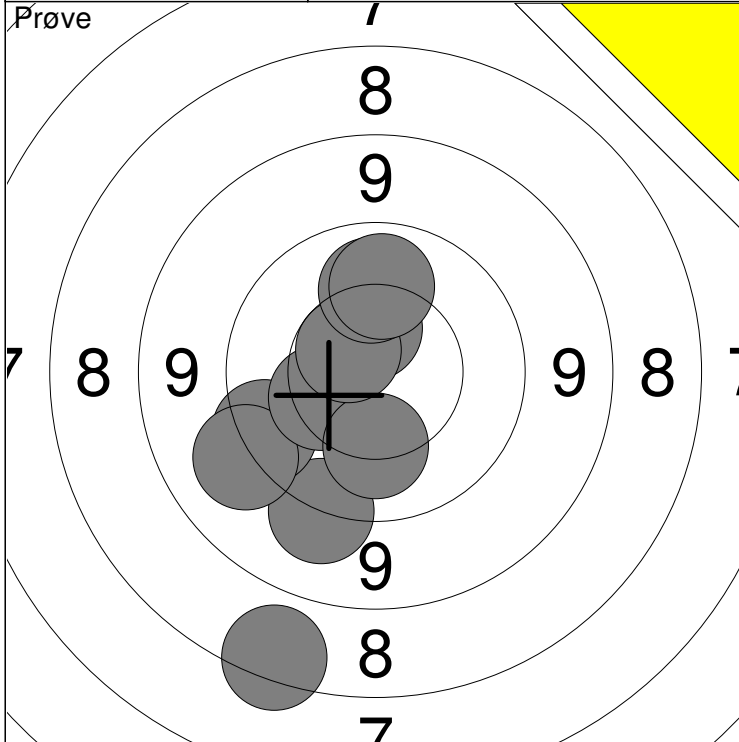

| | | | |
|-----------|------------|-------|----|
| 1: 7.6 ↓ | 6: 10.2 ↓ | Serie | 94 |
| 2: 9.4 ↓ | 7: 10.5 ↑ | | |
| 3: 9.6 ← | 8: 10.6x ↖ | Total | 0 |
| 4: 9.3 ← | 9: 10.1 ↑ | | |
| 5: 10.3 ← | 10: 10.1 ↑ | | |

| | | |
|-------------|-------|----|
| 11: 10.4 ↗ | Serie | 30 |
| 12: 10.4 ↖ | | |
| 13: 10.8x ↓ | Total | 0 |
| | | |

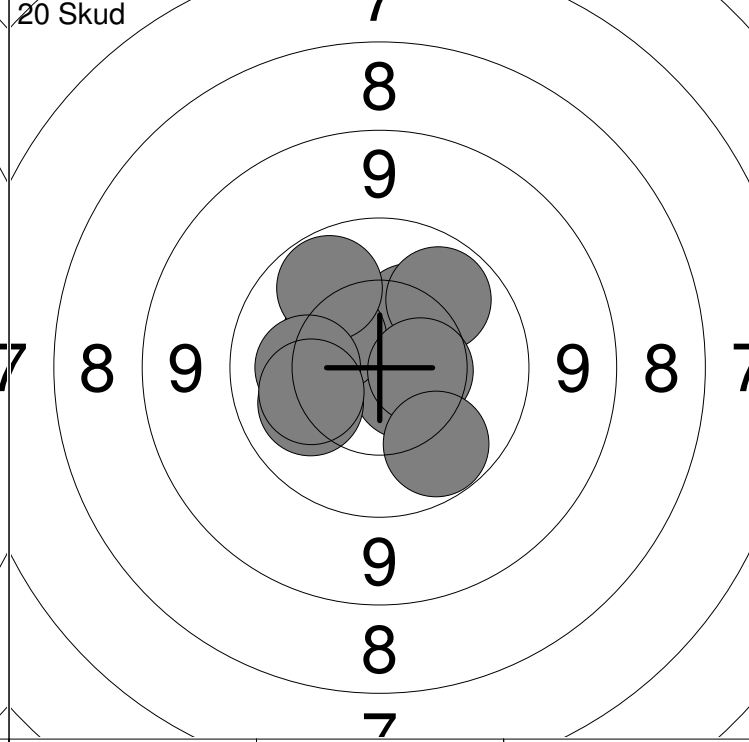
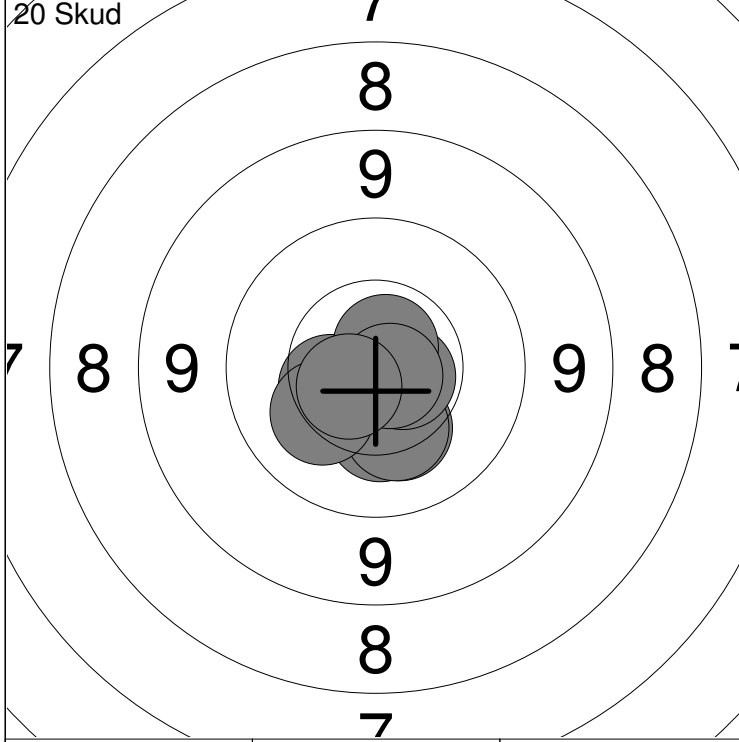

| | | | |
|------------|-------------|-------|-----|
| 1: 10.4 ← | 6: 10.7x → | Serie | 100 |
| 2: 10.7x → | 7: 10.2 ↘ | | |
| 3: 10.3 ↓ | 8: 10.7x ↗ | Total | 100 |
| 4: 10.3 ↓ | 9: 10.8x → | | |
| 5: 10.3 ↓ | 10: 10.6x ↖ | | |

| | | |
|-------------|------------|-----|
| 11: 10.6x ↘ | Serie | 100 |
| 12: 10.3 ↗ | | |
| 13: 10.0 ↗ | Total | 200 |
| 14: 10.4 ↖ | | |
| 15: 10.0 ↗ | 16: 10.1 ← | |
| | 17: 10.2 ← | |
| | 18: 10.2 ← | |
| | 19: 10.5 → | |
| | 20: 10.0 ↓ | |

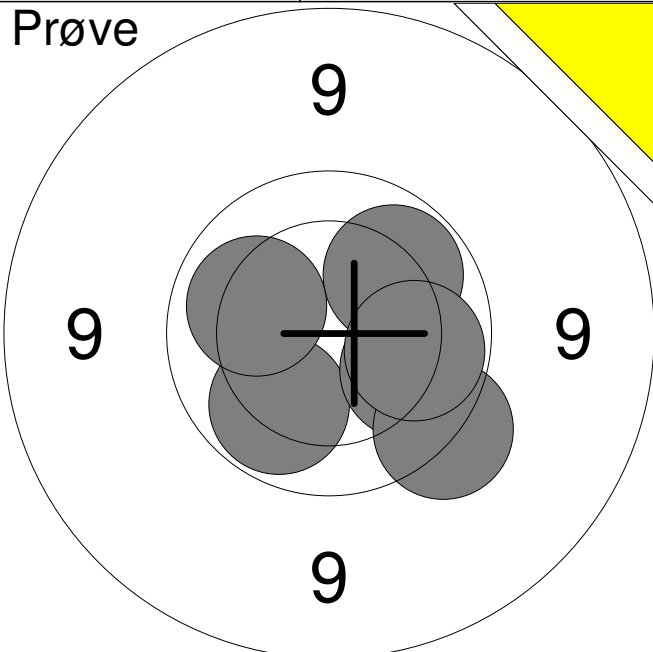
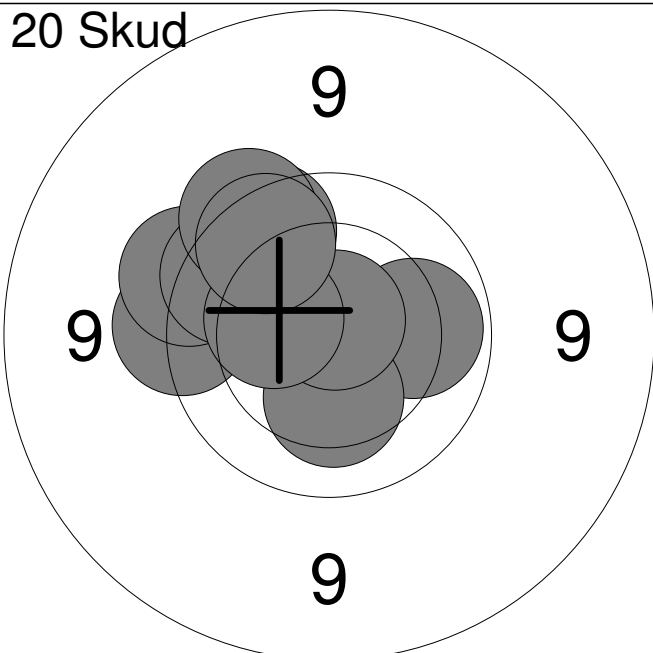
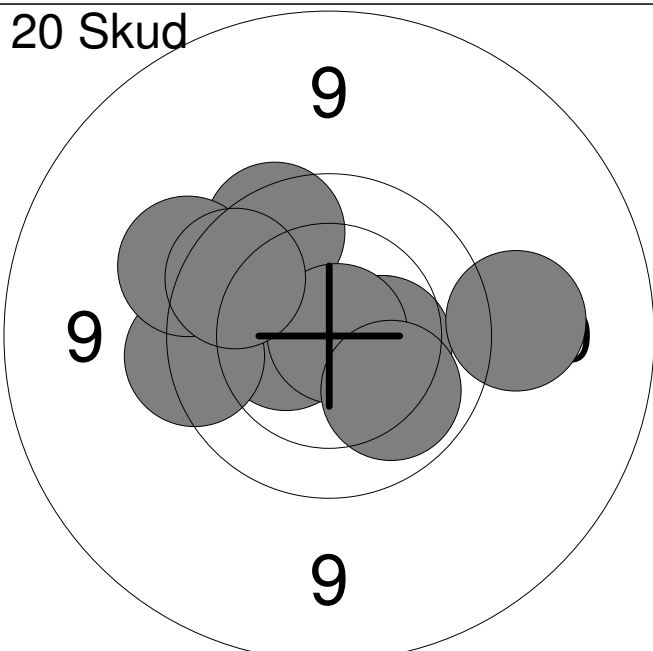
| Hold | Skive | Svend Peter Larsen | |
|---------|--|---------------------|--|
| 33 | 4 | | |
| 15m | Sæby og Omegns Skytteforening | MV2 | |
| | 15 meter riffelstævne oktober 2 | Aalborg Skyttekreds | |
| Prøve |  | 1: 10.0 ↙ | |
| | | 2: 10.0 → | |
| | | 3: 9.6 ↙ | |
| | | 4: 10.0 → | |
| | | 5: 10.0 → | |
| | | 6: 10.1 ↗ | |
| | Serie | 59.0 | |
| | Total | 0.0 | |
| 20 Skud |  | 1: 9.6 ← | |
| | | 2: 9.6 ↗ | |
| | | 3: 10.0 → | |
| | | 4: 9.8 ↗ | |
| | | 5: 10.3 ↓ | |
| | | 6: 10.8x ↗ | |
| | | 7: 9.8 ↗ | |
| | | 8: 9.6 ↗ | |
| | | 9: 10.3 ↗ | |
| | | 10: 9.8 ↗ | |
| | Serie | 94.0 | |
| | Total | 94.0 | |
| 20 Skud |  | 11: 10.4 → | |
| | | 12: 10.4 → | |
| | | 13: 10.5 ← | |
| | | 14: 9.8 ↗ | |
| | | 15: 10.9x → | |
| | | 16: 9.7 ← | |
| | | 17: 9.6 ↗ | |
| | | 18: 9.8 ↗ | |
| | | 19: 10.1 ↓ | |
| | | 20: 9.4 → | |
| | Serie | 95.0 | |
| | Total | 189.0 | |

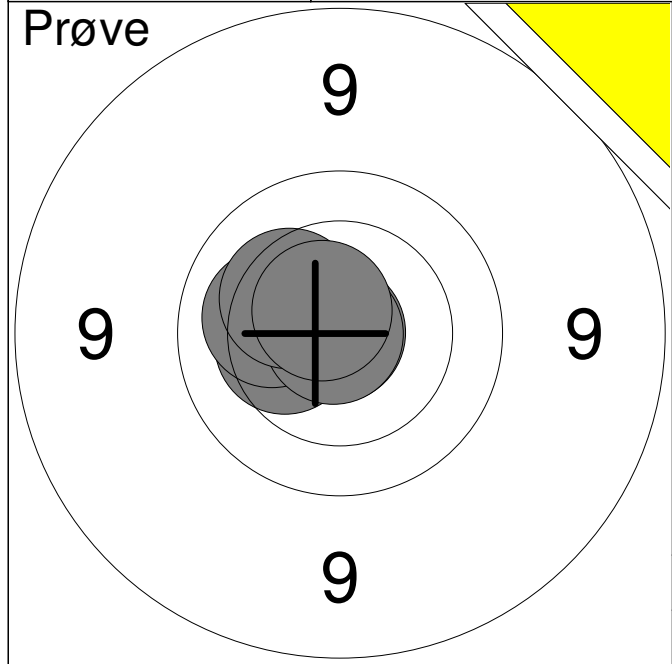

| | | |
|--------------|-------|-------------|
| 1: | 10.3 | ← |
| 2: | 10.9x | ← |
| 3: | 10.3 | ↗ |
| 4: | 10.2 | ← |
| 5: | 10.9x | ← |
| 6: | 10.3 | ↗ |
| 7: | 10.6x | ↗ |
| Serie | | 70.0 |
| Total | | 0.0 |

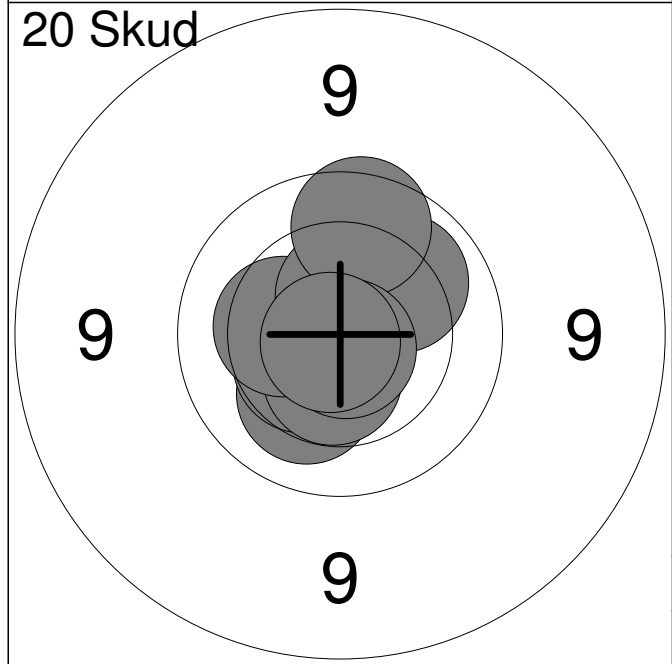

| | | |
|--------------|-------|-------------|
| 1: | 10.2 | ↙ |
| 2: | 10.4 | ↙ |
| 3: | 10.5x | ↓ |
| 4: | 10.4 | ↗ |
| 5: | 10.3 | ← |
| 6: | 10.5x | ↑ |
| 7: | 10.1 | ↗ |
| 8: | 9.8 | ↑ |
| 9: | 10.8x | ↓ |
| 10: | 10.8x | ↙ |
| Serie | | 99.0 |
| Total | | 99.0 |

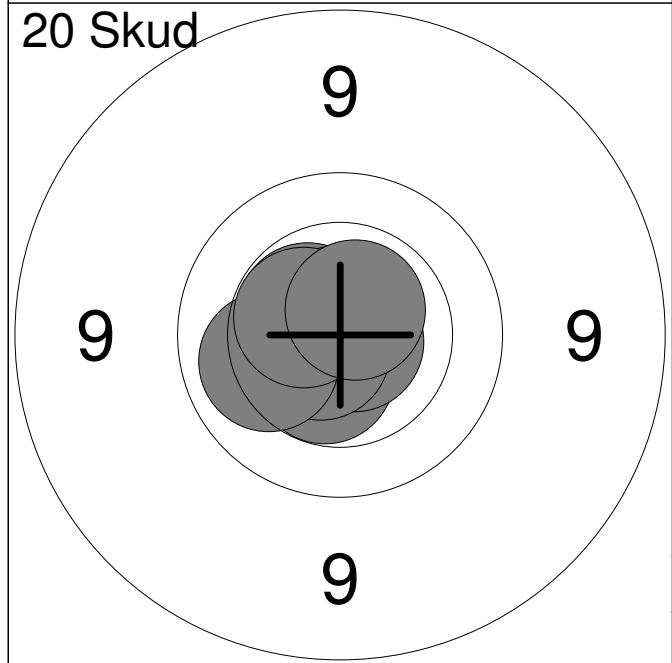

| | | |
|--------------|-------|--------------|
| 11: | 10.5x | ↙ |
| 12: | 10.5x | ↗ |
| 13: | 10.9x | ↗ |
| 14: | 10.8x | ↘ |
| 15: | 10.7x | ↗ |
| 16: | 10.7x | ↗ |
| 17: | 10.7x | ↙ |
| 18: | 10.1 | ← |
| 19: | 10.5x | ↗ |
| 20: | 10.6x | ↗ |
| Serie | | 100.0 |
| Total | | 199.0 |

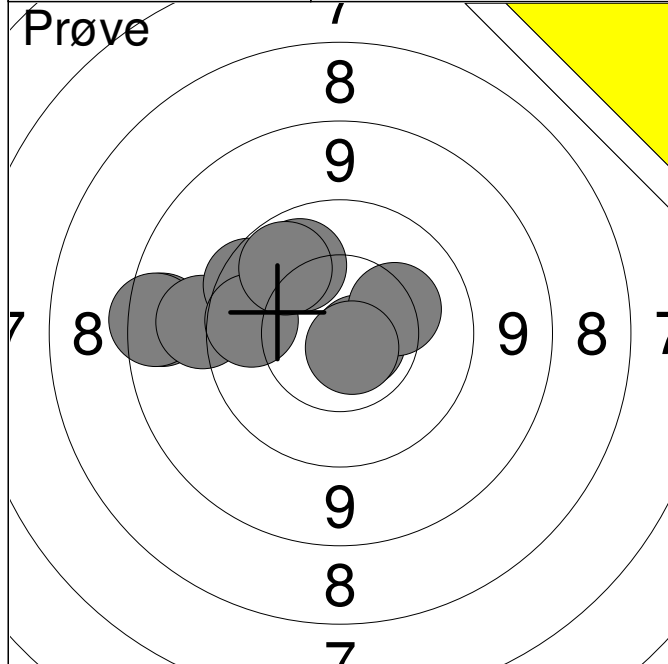

| | | |
|--------------|-------|-------------|
| 1: | 8.8 | ← |
| 2: | 8.7 | ← |
| 3: | 9.3 | ← |
| 4: | 9.8 | ↗ |
| 5: | 10.0 | ↗ |
| 6: | 10.7x | ↘ |
| 7: | 9.9 | ← |
| 8: | 10.0 | ↗ |
| 9: | 10.3 | → |
| 10: | 10.7x | ↘ |
| Serie | | 93.0 |
| Total | | 0.0 |

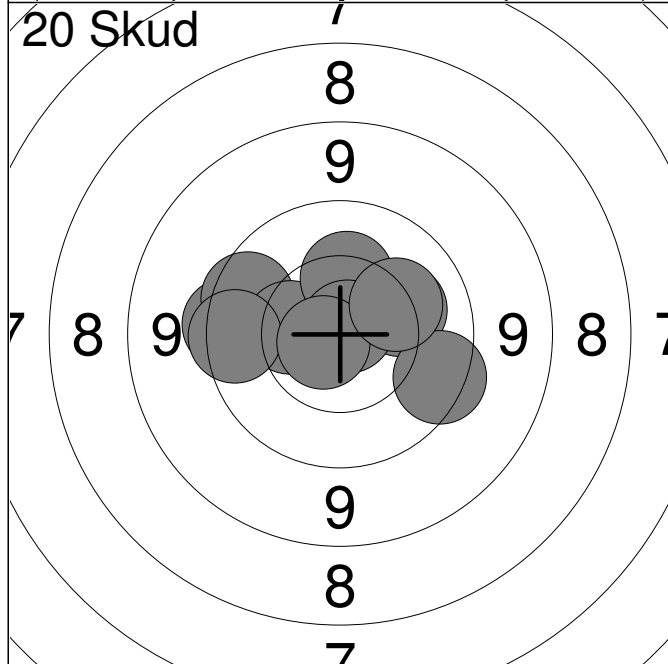

| | | |
|--------------|-------|-------------|
| 1: | 9.6 | ← |
| 2: | 9.8 | ← |
| 3: | 10.2 | → |
| 4: | 9.7 | ↘ |
| 5: | 10.4 | ← |
| 6: | 9.7 | ← |
| 7: | 10.3 | ↑ |
| 8: | 10.8x | ↗ |
| 9: | 10.7x | ← |
| 10: | 10.2 | → |
| Serie | | 96.0 |
| Total | | 96.0 |

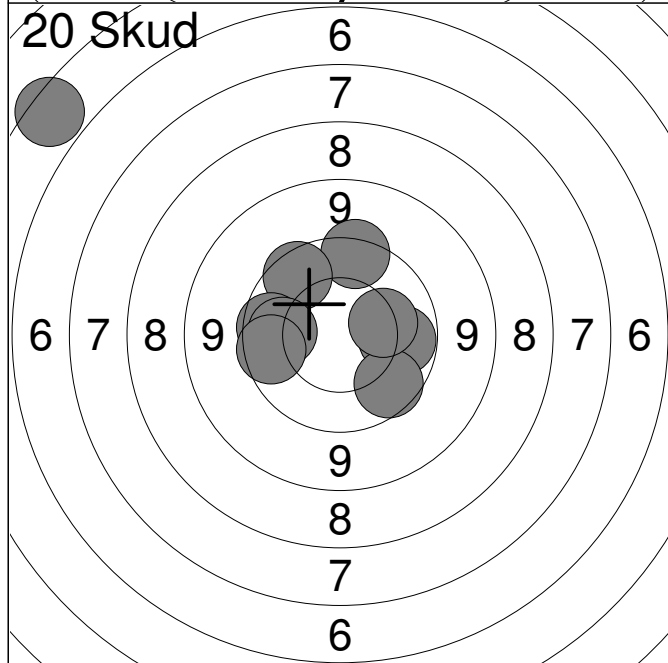

| | | |
|--------------|------|--------------|
| 11: | 9.6 | ↑ |
| 12: | 9.8 | ↗ |
| 13: | 10.1 | → |
| 14: | 9.8 | ← |
| 15: | 10.0 | → |
| 16: | 4.7 | ↗ |
| 17: | 9.9 | ↘ |
| 18: | 10.0 | ← |
| 19: | 10.2 | → |
| 20: | 9.8 | ← |
| Serie | | 89.0 |
| Total | | 185.0 |

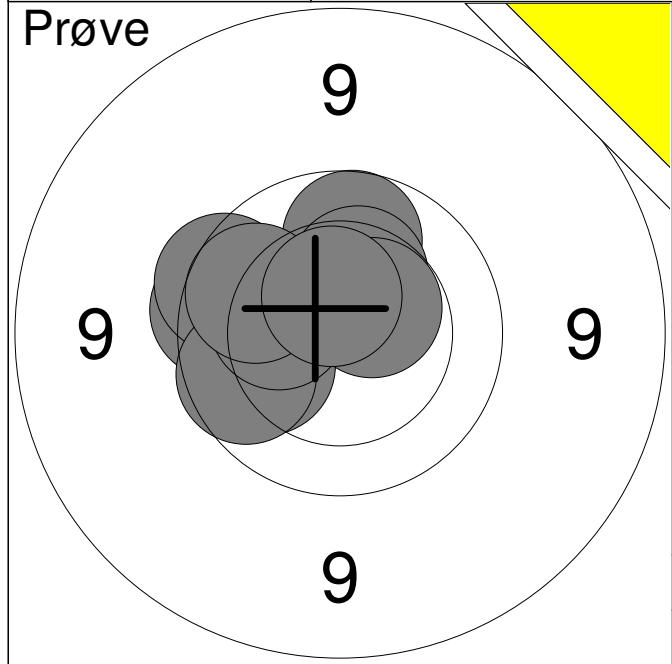

| | | |
|--------------|-------|-------------|
| 1: | 10.1 | ← |
| 2: | 9.8 | ← |
| 3: | 9.7 | ↖ |
| 4: | 9.9 | ↑ |
| 5: | 9.9 | ← |
| 6: | 10.3 | ← |
| 7: | 9.9 | ↖ |
| 8: | 10.3 | ↑ |
| 9: | 10.5x | ↗ |
| 10: | 10.5x | ↑ |
| Serie | | 95.0 |
| Total | | 0.0 |

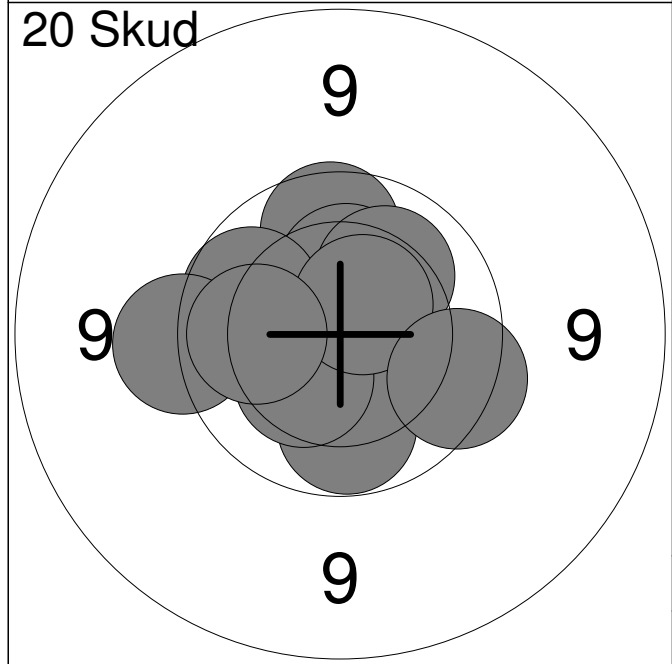

| | | |
|--------------|-------|-------------|
| 1: | 9.9 | ↑ |
| 2: | 10.3 | ↑ |
| 3: | 10.2 | ↗ |
| 4: | 9.9 | ← |
| 5: | 10.0 | ↓ |
| 6: | 10.3 | ↙ |
| 7: | 10.5x | ↗ |
| 8: | 9.7 | → |
| 9: | 9.5 | ← |
| 10: | 10.1 | ← |
| Serie | | 96.0 |
| Total | | 96.0 |

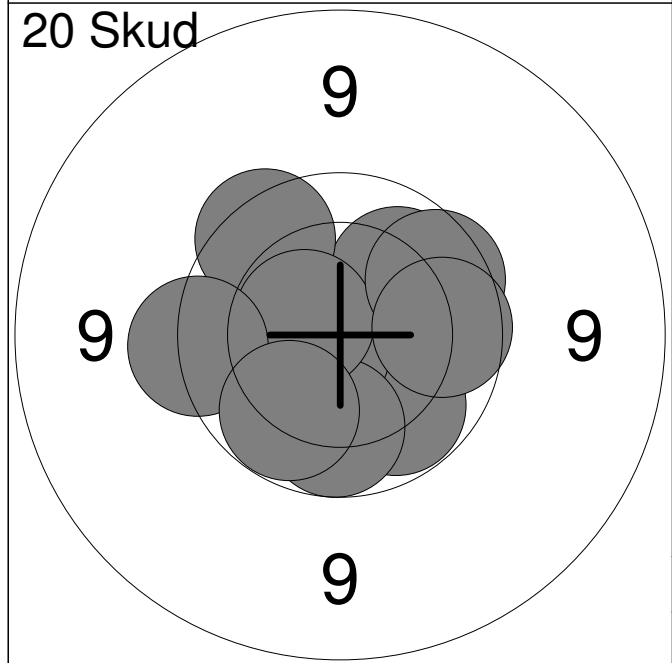

| | | |
|--------------|-------|--------------|
| 11: | 10.1 | ↗ |
| 12: | 10.0 | ↘ |
| 13: | 9.8 | ↗ |
| 14: | 10.7x | ↙ |
| 15: | 10.0 | ↓ |
| 16: | 10.5x | ↖ |
| 17: | 9.8 | ↗ |
| 18: | 9.9 | → |
| 19: | 9.6 | ← |
| 20: | 10.0 | ↙ |
| Serie | | 96.0 |
| Total | | 192.0 |

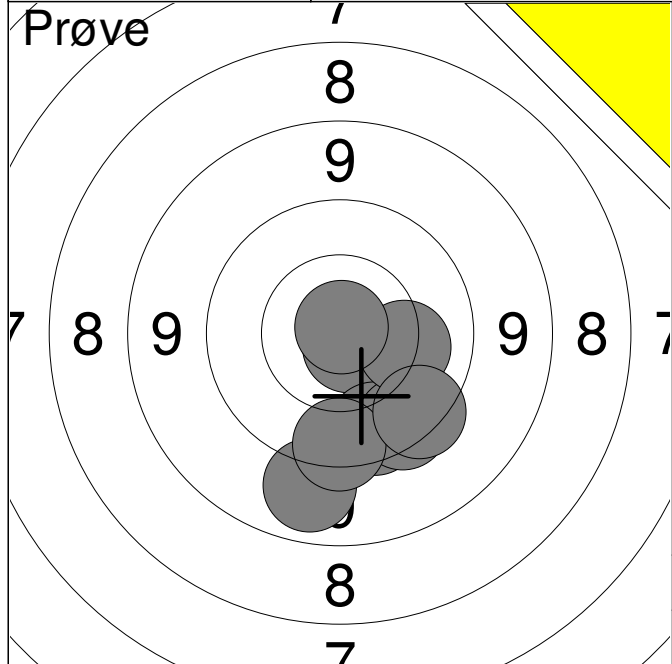

| | | |
|--------------|-------|-------------|
| 1: | 10.8x | ↓ |
| 2: | 9.1 | ↓ |
| 3: | 9.8 | ↓ |
| 4: | 9.7 | ↓ |
| 5: | 9.6 | ↓ |
| 6: | 10.2 | → |
| 7: | 9.6 | ↓ |
| 8: | 10.9x | ↑ |
| Serie | | 75.0 |
| Total | | 0.0 |

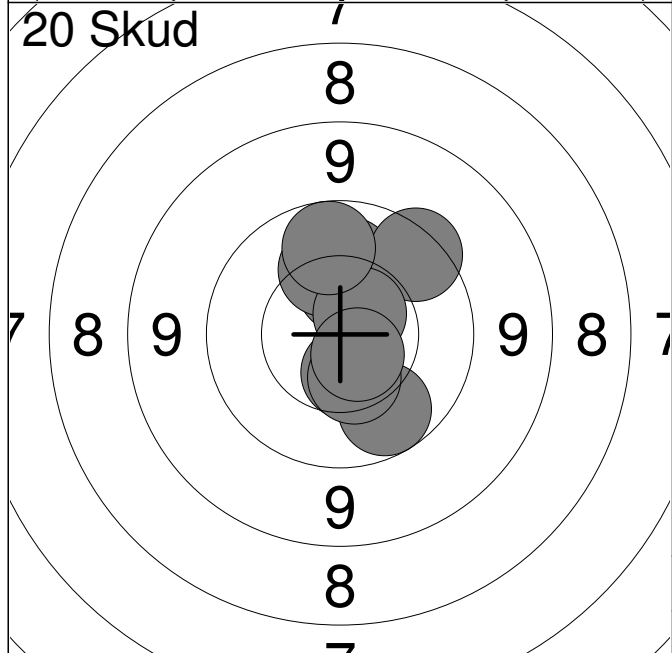

| | | |
|--------------|-------|-------------|
| 1: | 10.5 | ↓ |
| 2: | 10.4 | ↑ |
| 3: | 9.9 | ↓ |
| 4: | 10.1 | ↑ |
| 5: | 10.4 | ↓ |
| 6: | 9.7 | ↗ |
| 7: | 10.2 | ↑ |
| 8: | 10.6x | ↗ |
| 9: | 9.9 | ↑ |
| 10: | 10.6x | ↓ |
| Serie | | 97.0 |
| Total | | 97.0 |

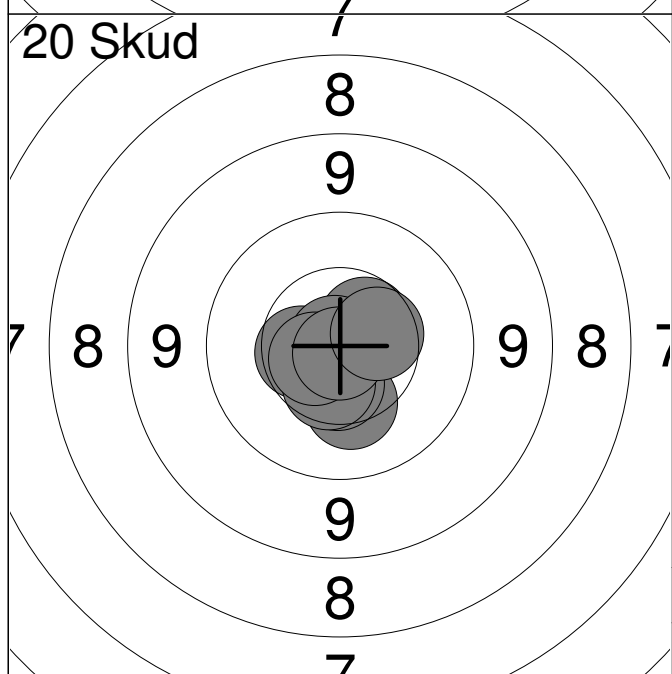

| | | |
|--------------|-------|--------------|
| 11: | 10.6 | ↗ |
| 12: | 10.8x | ↓ |
| 13: | 10.5 | ← |
| 14: | 10.3 | ↓ |
| 15: | 10.9x | ↗ |
| 16: | 10.5 | ↓ |
| 17: | 10.5 | ↓ |
| 18: | 10.6x | ← |
| 19: | 10.9x | ↓ |
| 20: | 10.5 | → |
| Serie | | 100.0 |
| Total | | 197.0 |

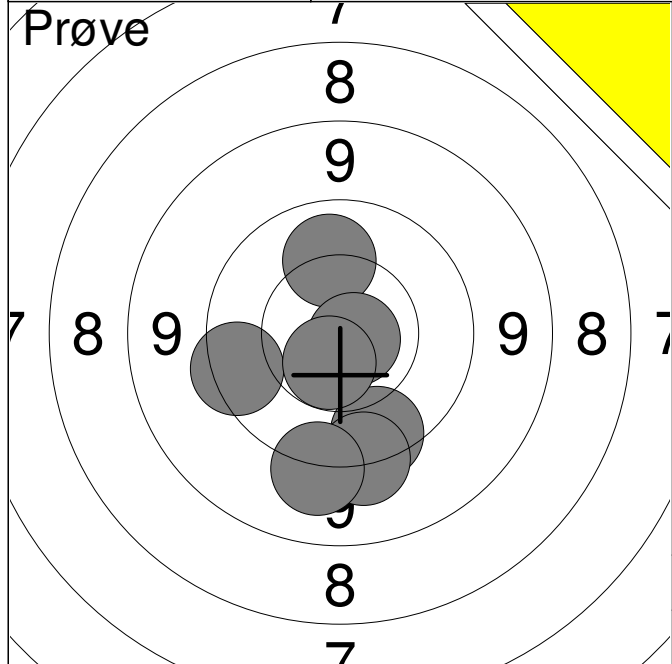

| | | |
|--------------|-------|-------------|
| 1: | 9.7 | ↓ |
| 2: | 9.4 | ↓ |
| 3: | 9.3 | ↓ |
| 4: | 9.7 | ← |
| 5: | 10.1 | ↑ |
| 6: | 10.8x | → |
| 7: | 10.6x | ↓ |
| Serie | | 66.0 |
| Total | | 0.0 |

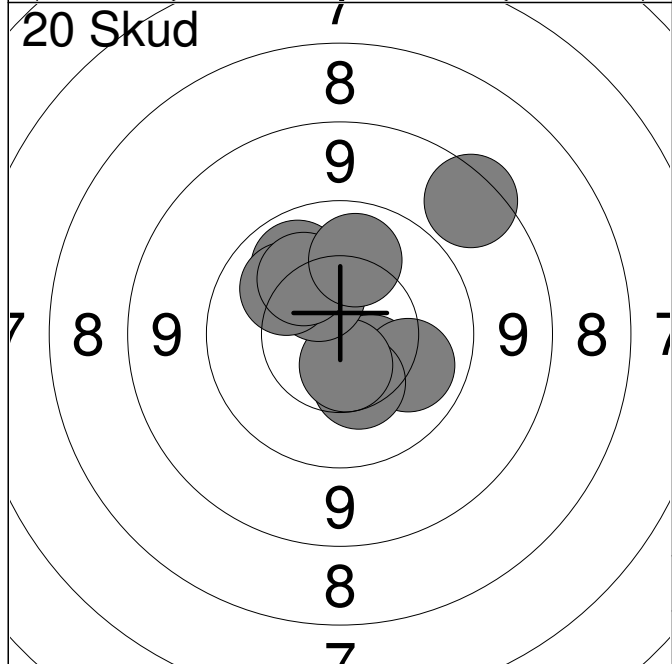

| | | |
|--------------|-------|-------------|
| 1: | 8.7 | ↗ |
| 2: | 10.5 | ↓ |
| 3: | 10.1 | ↓ |
| 4: | 10.3 | ↓ |
| 5: | 10.6x | ↓ |
| 6: | 10.4 | ↗ |
| 7: | 10.0 | ↗ |
| 8: | 10.1 | ↗ |
| 9: | 10.2 | ↗ |
| 10: | 10.1 | ↗ |
| Serie | | 98.0 |
| Total | | 98.0 |

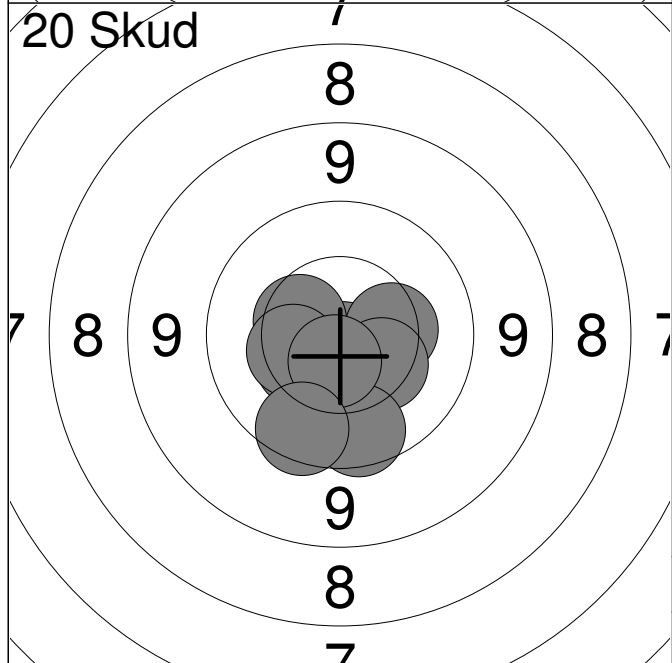

| | | |
|--------------|-------|--------------|
| 11: | 10.8x | ↓ |
| 12: | 10.5 | ↗ |
| 13: | 10.4 | → |
| 14: | 10.4 | ↓ |
| 15: | 10.5 | ↓ |
| 16: | 10.4 | ← |
| 17: | 10.4 | ← |
| 18: | 9.8 | ↓ |
| 19: | 10.6x | ↓ |
| 20: | 9.8 | ↓ |
| Serie | | 98.0 |
| Total | | 196.0 |

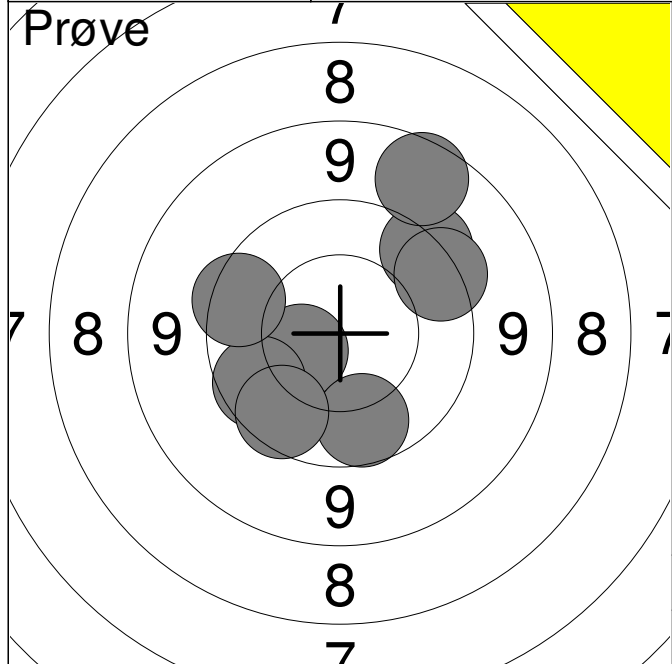

| | | |
|--------------|------|-------------|
| 1: | 9.5 | ↗ |
| 2: | 10.5 | ↖ |
| 3: | 9.6 | ↗ |
| 4: | 9.9 | ↓ |
| 5: | 9.8 | ↖ |
| 6: | 9.8 | ↖ |
| 7: | 9.7 | ↖ |
| 8: | 8.8 | ↗ |
| Serie | | 72.0 |
| Total | | 0.0 |

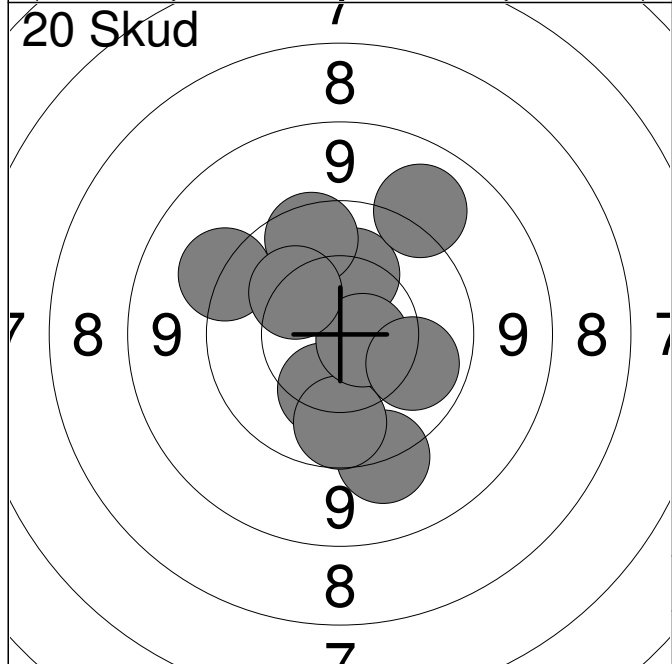

| | | |
|--------------|-------|-------------|
| 1: | 9.4 | ↓ |
| 2: | 10.2 | ↑ |
| 3: | 9.8 | ↑ |
| 4: | 10.3 | ↓ |
| 5: | 9.9 | ↓ |
| 6: | 10.7x | → |
| 7: | 9.2 | ↗ |
| 8: | 10.0 | → |
| 9: | 9.4 | ↗ |
| 10: | 10.2 | ↗ |
| Serie | | 95.0 |
| Total | | 95.0 |

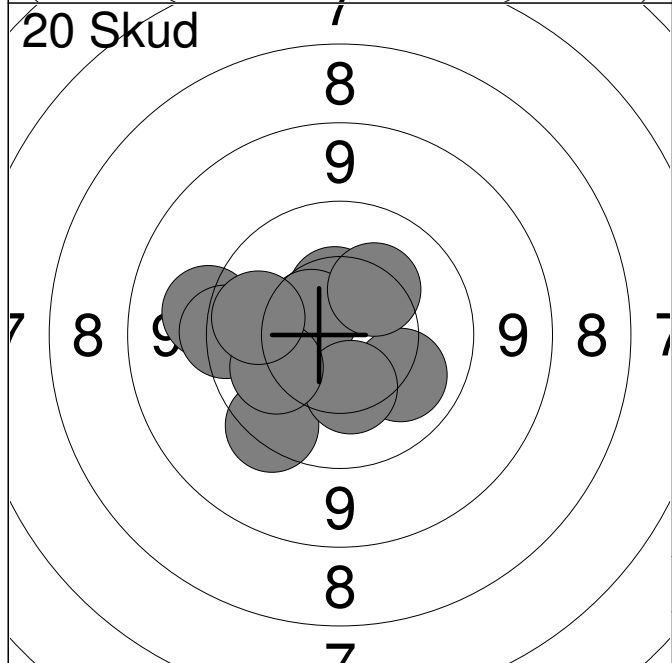

| | | |
|--------------|------|--------------|
| 11: | 9.6 | ↖ |
| 12: | 9.3 | ↖ |
| 13: | 9.6 | ↖ |
| 14: | 10.1 | ↓ |
| 15: | 10.5 | ↑ |
| 16: | 10.6 | ↗ |
| 17: | 10.3 | ↓ |
| 18: | 10.1 | ↖ |
| 19: | 10.3 | ↗ |
| 20: | 10.0 | ↖ |
| Serie | | 97.0 |
| Total | | 192.0 |

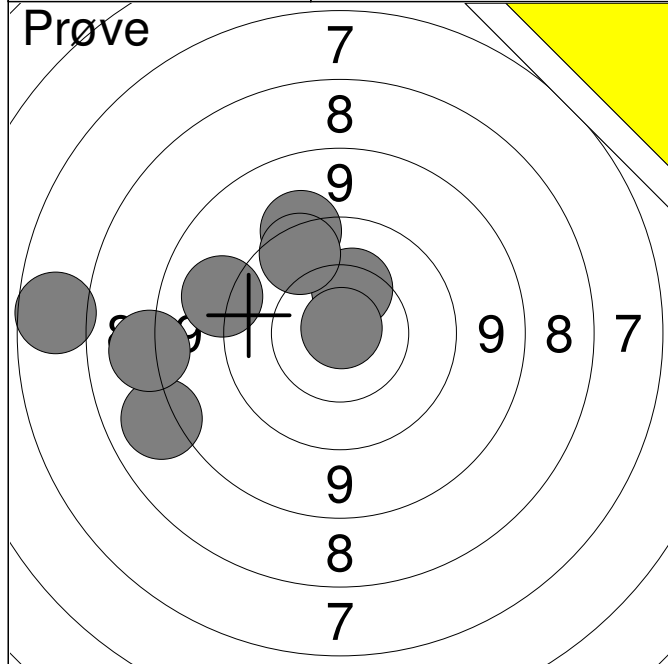

| | | |
|--------------|-------|-------------|
| 1: | 6.9 | ← |
| 2: | 8.2 | ↙ |
| 3: | 9.2 | ← |
| 4: | 8.3 | ← |
| 5: | 10.3 | ↑ |
| 6: | 9.5 | ↑ |
| 7: | 9.8 | ↑ |
| 8: | 10.9x | ↑ |
| Serie | | 69.0 |
| Total | | 0.0 |

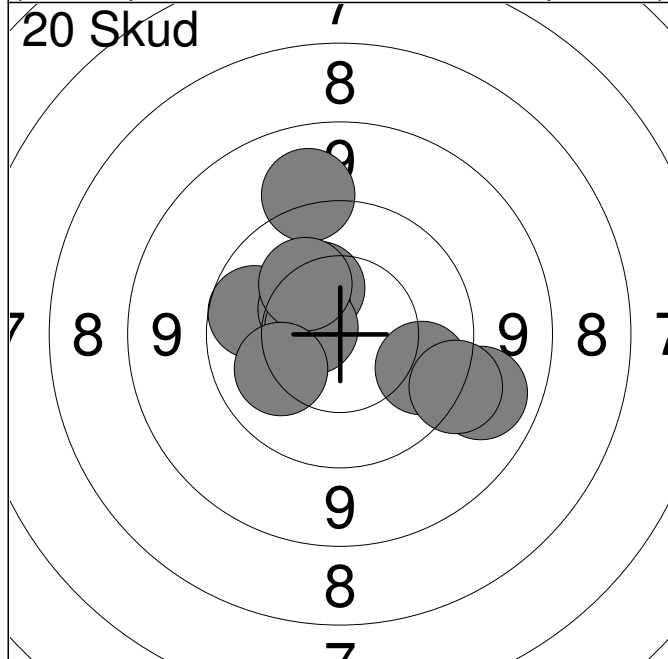

| | | |
|--------------|-------|-------------|
| 1: | 9.9 | ← |
| 2: | 9.9 | ↘ |
| 3: | 9.2 | ↑ |
| 4: | 10.4 | ↑ |
| 5: | 10.5 | ↑ |
| 6: | 10.6x | ↑ |
| 7: | 10.2 | ↑ |
| 8: | 9.1 | ↘ |
| 9: | 9.4 | ↘ |
| 10: | 10.2 | ↙ |
| Serie | | 95.0 |
| Total | | 95.0 |

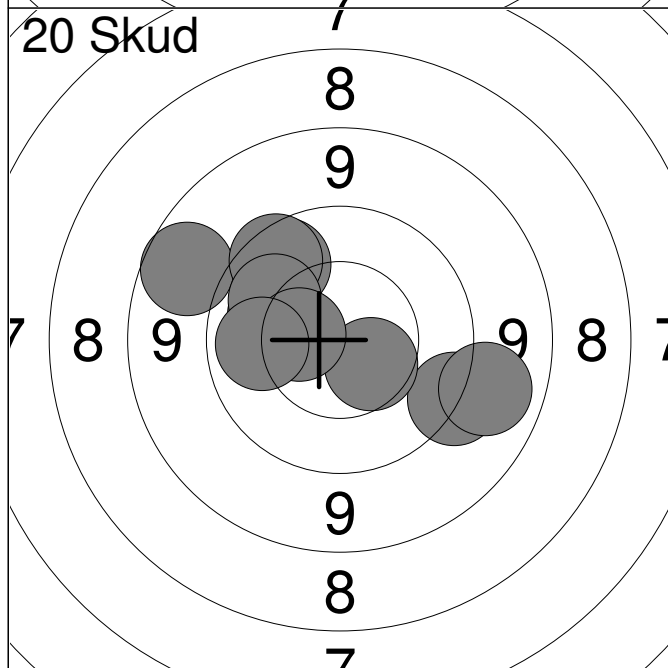

| | | |
|--------------|------|--------------|
| 11: | 9.4 | ↘ |
| 12: | 9.9 | ↑ |
| 13: | 10.1 | ↑ |
| 14: | 8.9 | ↑ |
| 15: | 9.8 | ↑ |
| 16: | 10.5 | ↘ |
| 17: | 10.1 | ↑ |
| 18: | 10.5 | ↑ |
| 19: | 9.1 | ↘ |
| 20: | 10.0 | ← |
| Serie | | 94.0 |
| Total | | 189.0 |

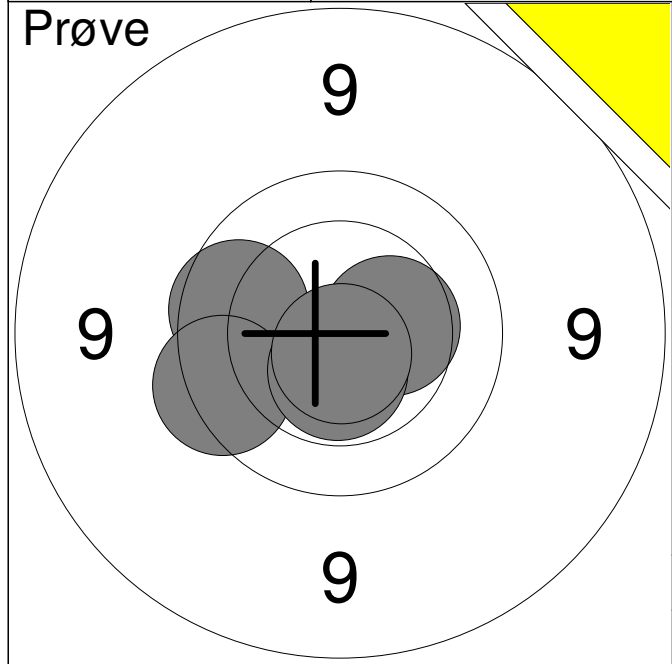

| | | |
|--------------|-------|-------------|
| 1: | 9.9 | ← |
| 2: | 9.7 | ← |
| 3: | 10.4 | → |
| 4: | 10.5x | ↓ |
| 5: | 10.7x | ↓ |
| Serie | | 48.0 |
| Total | | 0.0 |

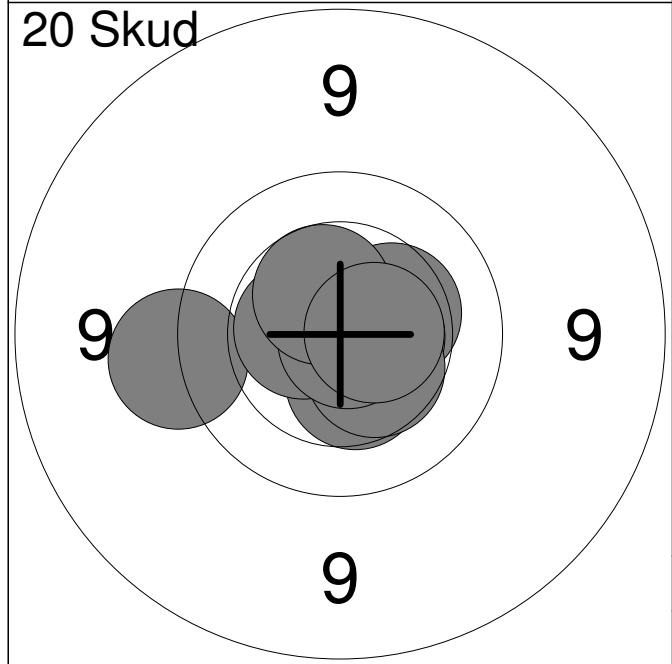

| | | |
|--------------|-------|-------------|
| 1: | 10.3 | → |
| 2: | 10.8x | ↑ |
| 3: | 9.5 | ← |
| 4: | 10.6x | → |
| 5: | 10.4 | ↓ |
| 6: | 10.6x | ← |
| 7: | 10.4 | ↓ |
| 8: | 10.9x | ↓ |
| 9: | 10.5 | ↑ |
| 10: | 10.6x | → |
| Serie | | 99.0 |
| Total | | 99.0 |

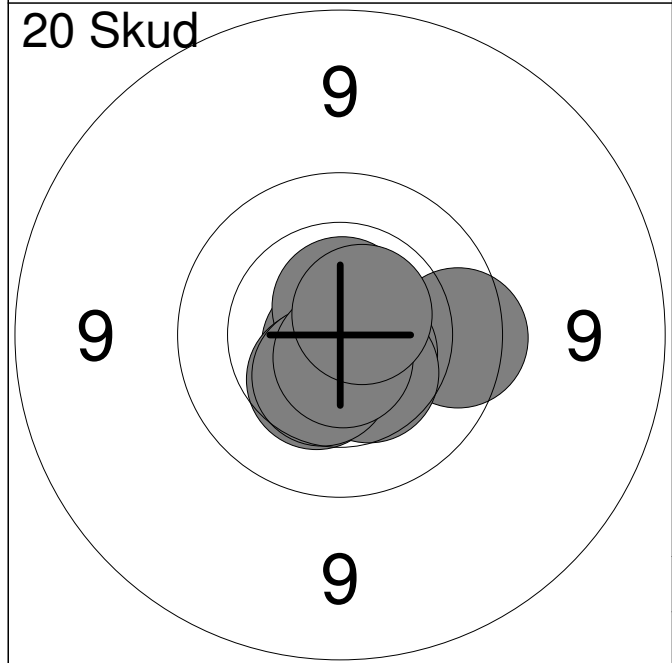

| | | |
|--------------|-------|--------------|
| 11: | 9.8 | → |
| 12: | 10.8x | ← |
| 13: | 10.6x | ↓ |
| 14: | 10.6x | ↑ |
| 15: | 10.6x | ↓ |
| 16: | 10.4 | ← |
| 17: | 10.4 | ↓ |
| 18: | 10.5 | ← |
| 19: | 10.7x | ↓ |
| 20: | 10.6x | ↗ |
| Serie | | 99.0 |
| Total | | 198.0 |

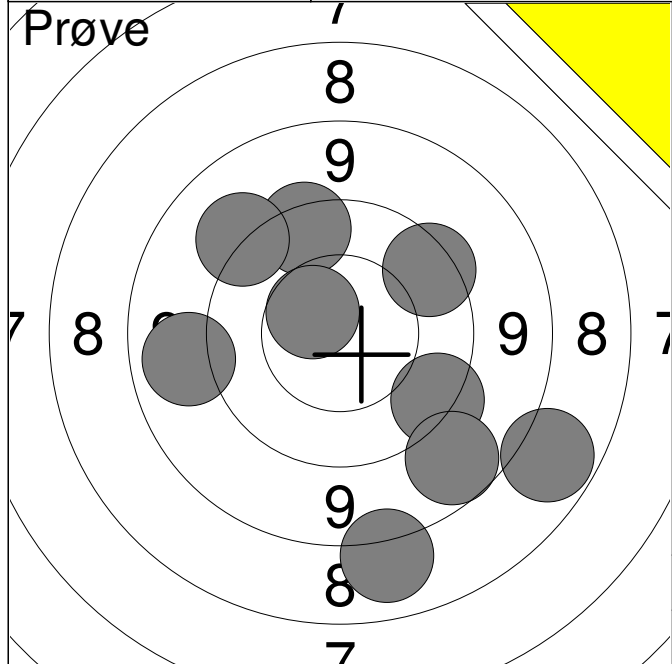

| | | |
|----|------|---|
| 1: | 9.1 | ← |
| 2: | 9.7 | ↗ |
| 3: | 9.6 | ↘ |
| 4: | 8.9 | ↘ |
| 5: | 8.2 | ↘ |
| 6: | 9.6 | ↗ |
| 7: | 8.0 | ↘ |
| 8: | 10.6 | ↗ |
| 9: | 9.3 | ↗ |

| | |
|-------|-------------|
| Serie | 79.0 |
| Total | 0.0 |

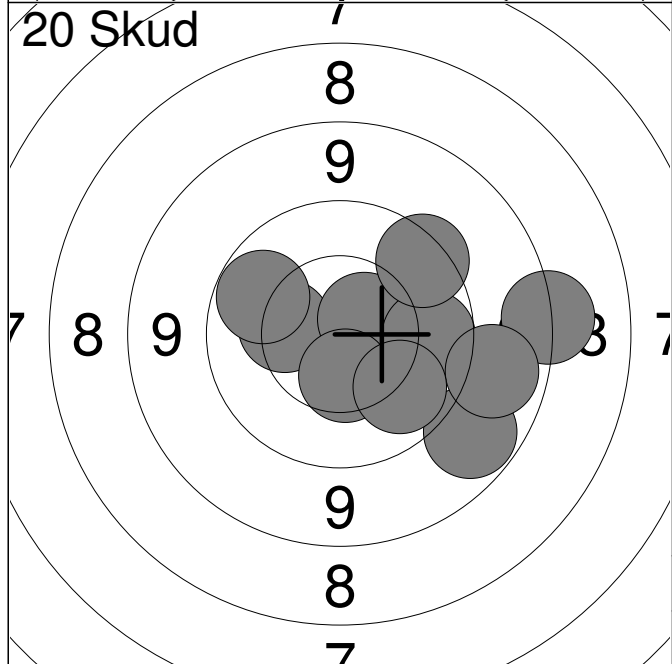

| | | |
|-----|-------|---|
| 1: | 9.0 | ↘ |
| 2: | 10.3 | ← |
| 3: | 10.0 | ↗ |
| 4: | 8.4 | → |
| 5: | 10.6x | ↗ |
| 6: | 9.9 | → |
| 7: | 9.1 | → |
| 8: | 10.5 | ↘ |
| 9: | 10.0 | ↘ |
| 10: | 9.6 | ↗ |

| | |
|-------|-------------|
| Serie | 94.0 |
| Total | 94.0 |

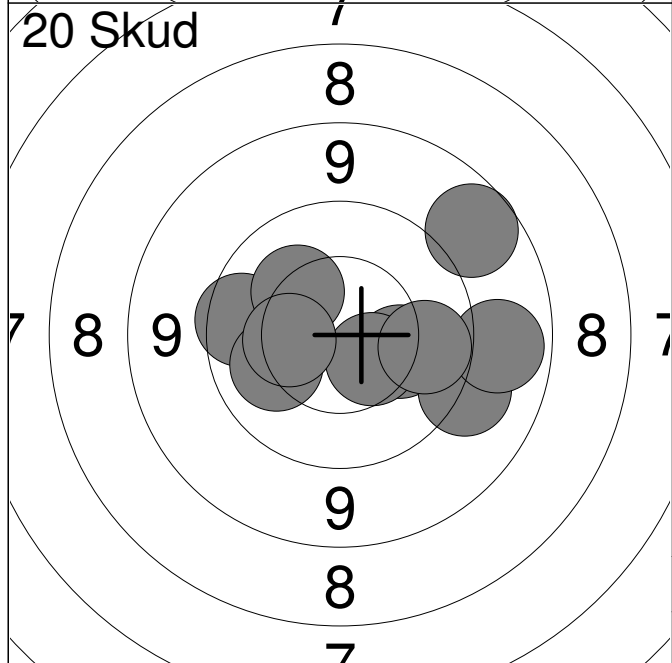

| | | |
|-----|------|---|
| 11: | 10.2 | → |
| 12: | 9.3 | ↘ |
| 13: | 9.0 | → |
| 14: | 8.9 | ↗ |
| 15: | 9.8 | ← |
| 16: | 10.5 | ↘ |
| 17: | 10.1 | ← |
| 18: | 10.0 | → |
| 19: | 10.3 | ↗ |
| 20: | 10.4 | ← |

| | |
|-------|--------------|
| Serie | 95.0 |
| Total | 189.0 |

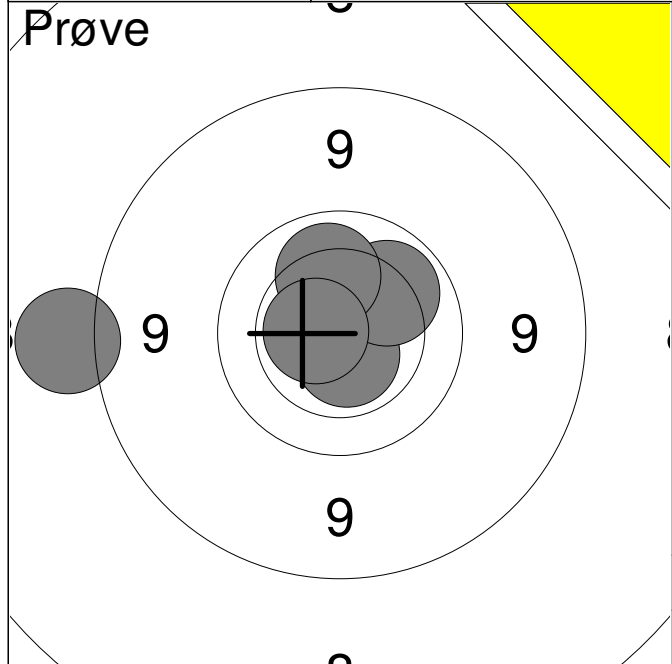

| | | |
|--------------|-------|-------------|
| 1: | 8.5 | ← |
| 2: | 10.6x | ↓ |
| 3: | 10.1 | ↗ |
| 4: | 10.1 | ↑ |
| 5: | 10.6x | ← |
| Serie | | 48.0 |
| Total | | 0.0 |

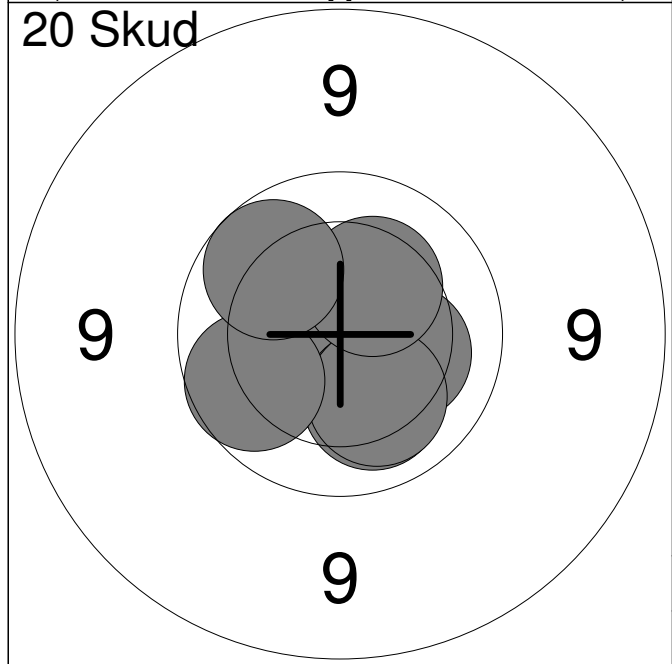

| | | |
|--------------|-------|-------------|
| 1: | 10.6x | ↙ |
| 2: | 10.4 | ↗ |
| 3: | 10.6x | ↓ |
| 4: | 10.8x | → |
| 5: | 10.2 | ↓ |
| 6: | 10.3 | ↗ |
| 7: | 10.2 | ↓ |
| 8: | 9.9 | ↙ |
| 9: | 10.3 | ↗ |
| 10: | 9.9 | ↗ |
| Serie | | 98.0 |
| Total | | 98.0 |

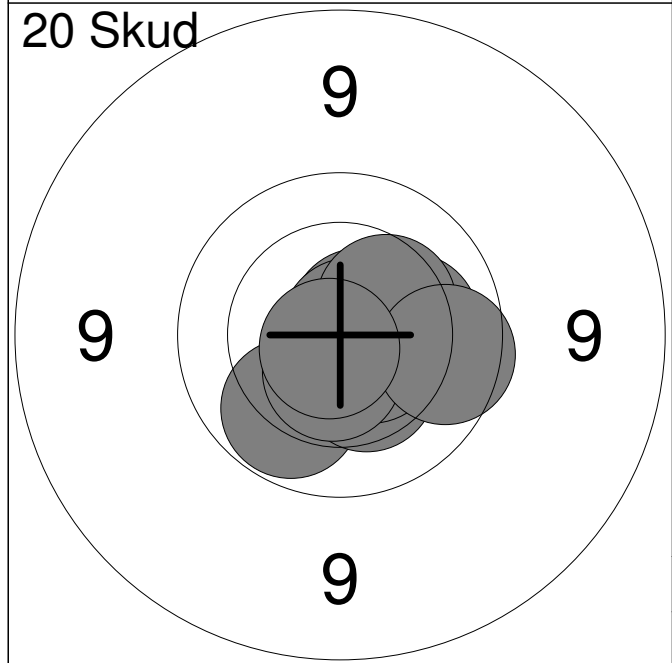

| | | |
|--------------|-------|--------------|
| 11: | 10.0 | ↙ |
| 12: | 10.4 | ↓ |
| 13: | 10.7x | ↗ |
| 14: | 10.8x | ↗ |
| 15: | 10.2 | → |
| 16: | 10.6x | ↓ |
| 17: | 10.5x | ↓ |
| 18: | 10.4 | ↗ |
| 19: | 9.9 | → |
| 20: | 10.8x | ↙ |
| Serie | | 99.0 |
| Total | | 197.0 |

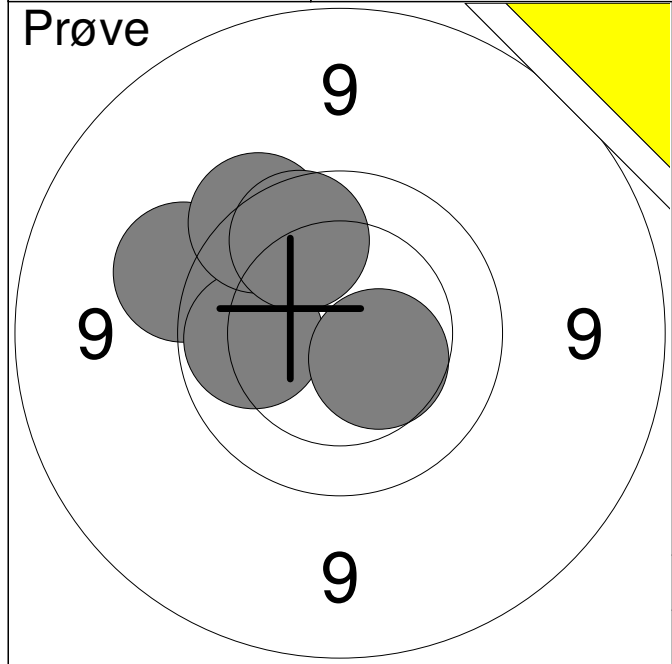

| | | |
|--------------|------|-------------|
| 1: | 9.5 | ↗ |
| 2: | 10.0 | ← |
| 3: | 9.7 | ↗ |
| 4: | 9.9 | ↗ |
| 5: | 10.5 | ↘ |
| Serie | | 47.0 |
| Total | | 0.0 |

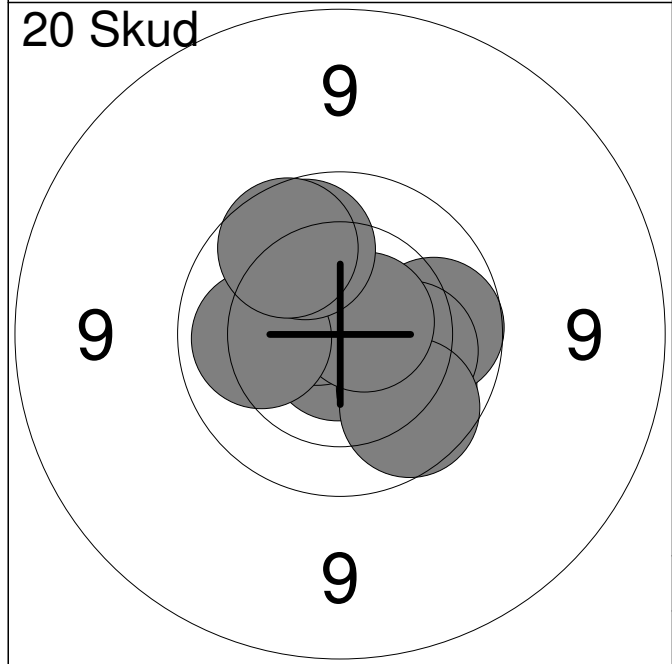

| | | |
|--------------|-------|-------------|
| 1: | 10.8x | ↘ |
| 2: | 10.0 | ↘ |
| 3: | 9.9 | → |
| 4: | 10.6x | ↗ |
| 5: | 10.2 | → |
| 6: | 9.9 | ↘ |
| 7: | 10.7x | → |
| 8: | 10.1 | ← |
| 9: | 10.0 | ↗ |
| 10: | 9.9 | ↗ |
| Serie | | 97.0 |
| Total | | 97.0 |

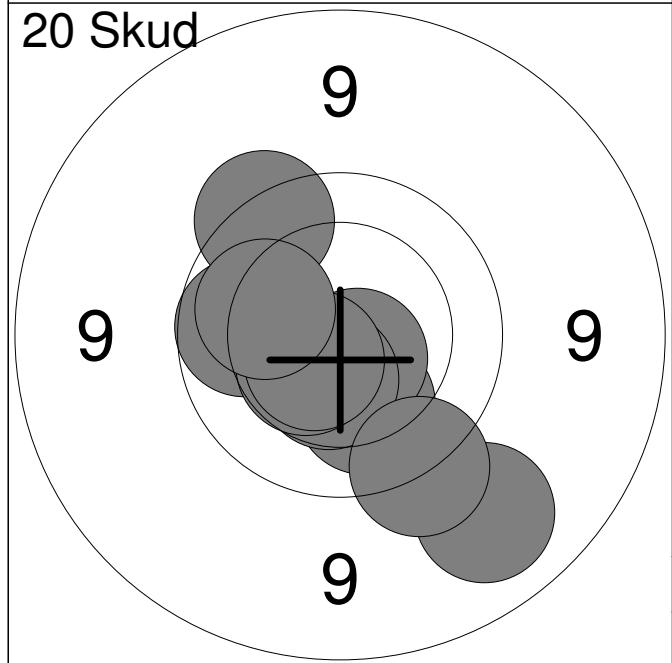

| | | |
|--------------|-------|--------------|
| 11: | 9.7 | ↗ |
| 12: | 9.1 | ↘ |
| 13: | 10.2 | ↘ |
| 14: | 10.6x | ↘ |
| 15: | 10.5 | ↘ |
| 16: | 9.9 | ← |
| 17: | 10.5 | ↖ |
| 18: | 10.6x | ↖ |
| 19: | 9.6 | ↘ |
| 20: | 10.1 | ← |
| Serie | | 96.0 |
| Total | | 193.0 |

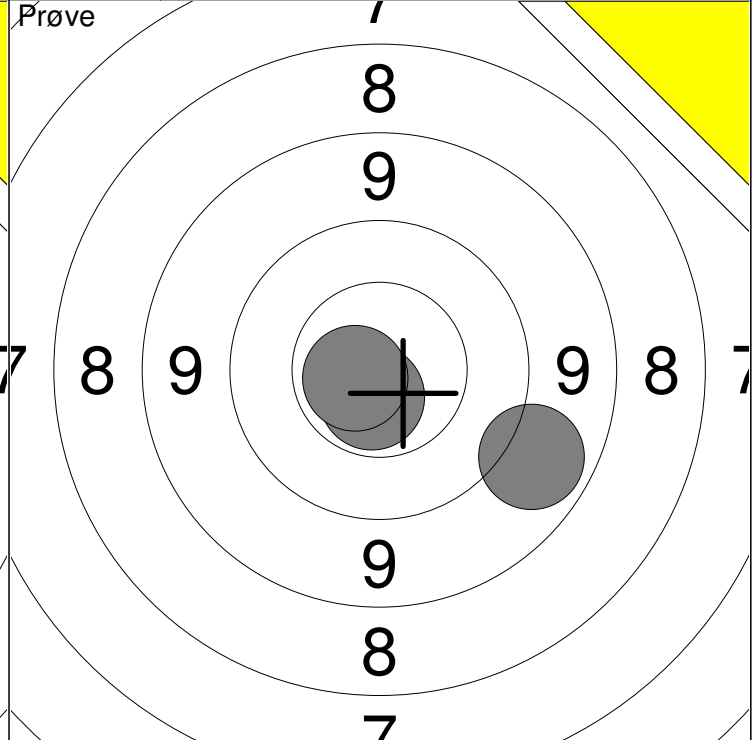
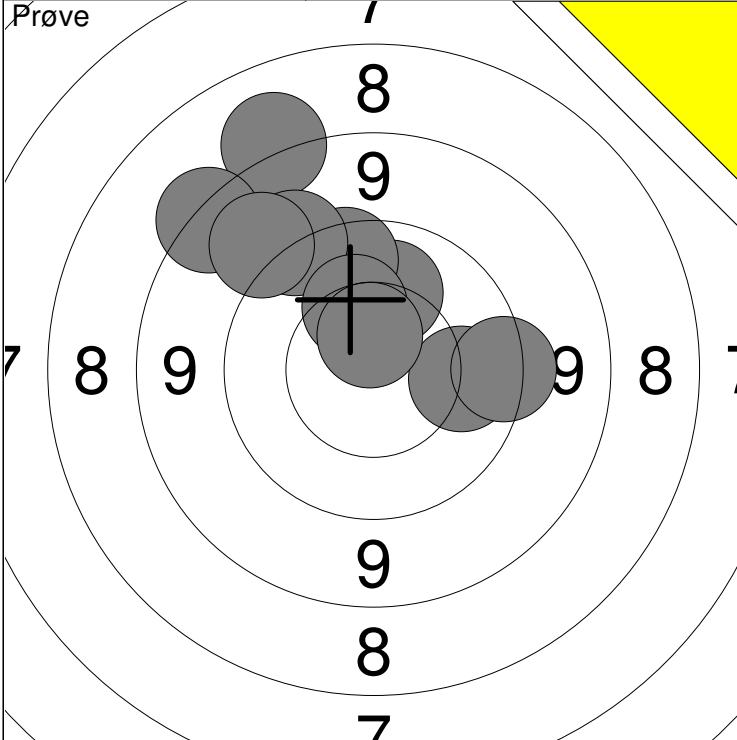

| | | | |
|-----------|-------------|-------|-------|
| 1: 10.1 ↑ | 6: 9.1 ↗ | Serie | 92 |
| 2: 8.3 ↗ | 7: 10.3 ↗ | | Total |
| 3: 8.5 ↗ | 8: 10.0 → | | |
| 4: 9.8 ↑ | 9: 9.6 → | | |
| 5: 9.4 ↗ | 10: 10.6x ↑ | | |

| | | |
|-------------|-------|-------|
| 11: 9.1 → | Serie | 29 |
| 12: 10.7x ↓ | | Total |
| 13: 10.7x ← | | |

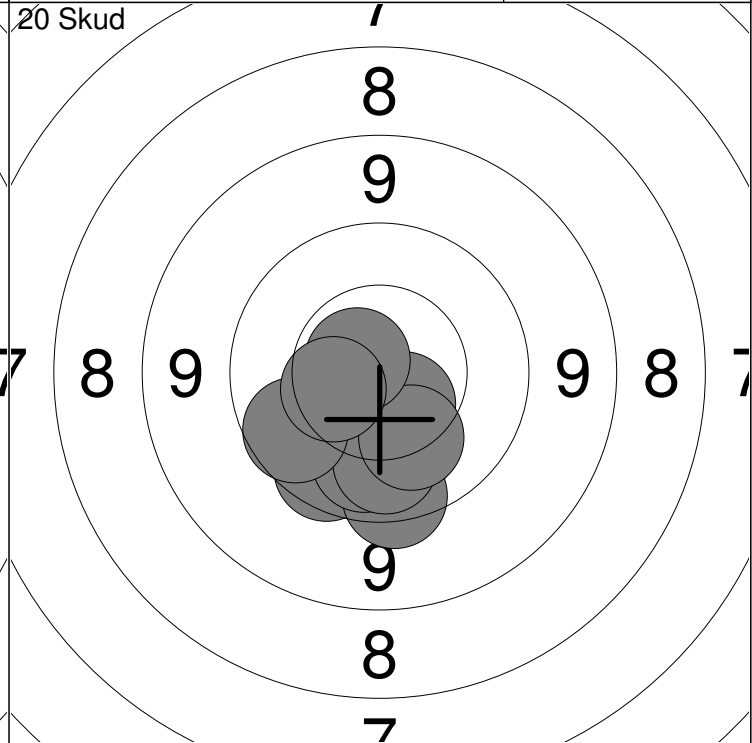
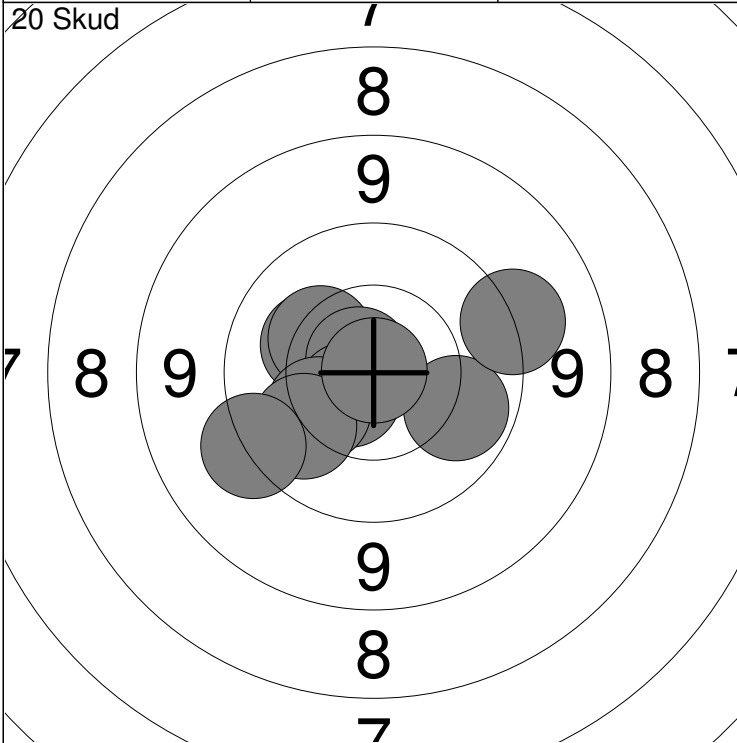

| | | | |
|------------|-------------|-------|-------|
| 1: 10.3 ↗ | 6: 10.6x ↙ | Serie | 98 |
| 2: 10.0 → | 7: 10.3 ↙ | | Total |
| 3: 10.3 ↗ | 8: 10.0 ↙ | | |
| 4: 9.4 → | 9: 9.5 ↙ | | |
| 5: 10.7x ↗ | 10: 10.9x ↗ | | |

| | | |
|-------------|-------|-------|
| 11: 10.5 ↓ | Serie | 97 |
| 12: 9.8 ↙ | | Total |
| 13: 10.2 ↓ | | |
| 14: 9.6 ↓ | | |
| 15: 10.0 ↓ | | |
| 16: 10.0 ↓ | | |
| 17: 10.2 ↓ | | |
| 18: 9.9 ↙ | | |
| 19: 10.7x ↙ | | |
| 20: 10.4 ↙ | | |

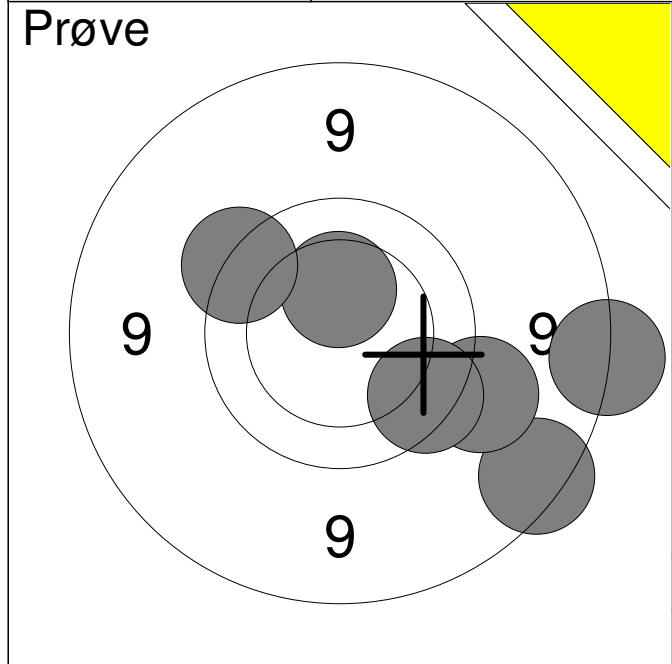

| | | | |
|--------------|----|-------------|---|
| | 1: | 8.8 | ↘ |
| | 2: | 8.7 | → |
| | 3: | 9.4 | ↘ |
| | 4: | 9.7 | ↘ |
| | 5: | 10.4 | ↑ |
| | 6: | 9.6 | ↗ |
| Serie | | 53.0 | |
| Total | | 0.0 | |

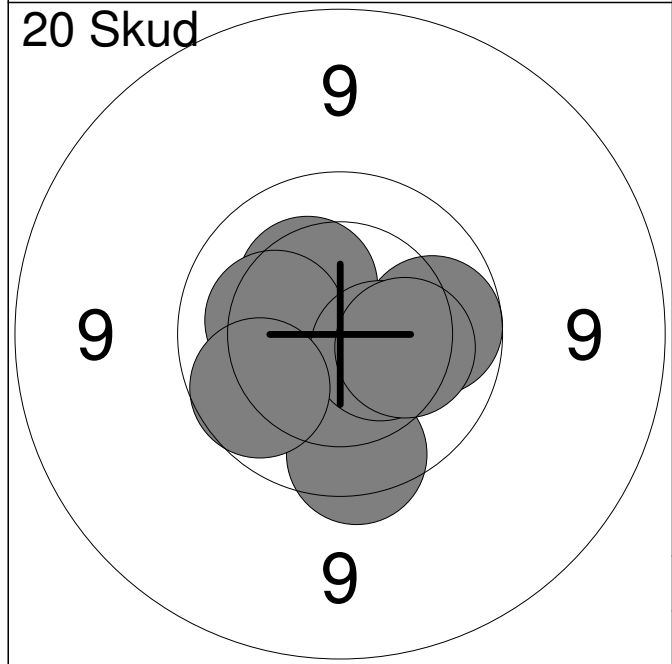

| | | | |
|--------------|-----|-------------|---|
| | 1: | 10.4 | ← |
| | 2: | 10.3 | ← |
| | 3: | 10.1 | ↘ |
| | 4: | 10.0 | → |
| | 5: | 10.3 | ↗ |
| | 6: | 10.2 | ↖ |
| | 7: | 9.8 | ↘ |
| | 8: | 10.5 | ↘ |
| | 9: | 10.2 | → |
| | 10: | 9.9 | ↘ |
| Serie | | 98.0 | |
| Total | | 98.0 | |

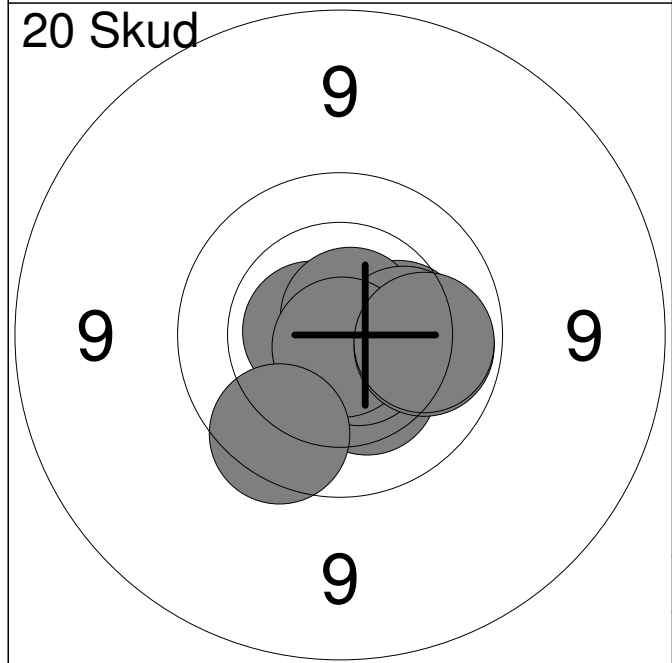

| | | | |
|--------------|-----|--------------|---|
| | 11: | 10.7x | ← |
| | 12: | 10.3 | → |
| | 13: | 10.3 | ↘ |
| | 14: | 10.7x | ↘ |
| | 15: | 10.7x | ↗ |
| | 16: | 10.3 | → |
| | 17: | 10.8x | ↘ |
| | 18: | 10.0 | → |
| | 19: | 9.8 | ↘ |
| | 20: | 10.0 | → |
| Serie | | 99.0 | |
| Total | | 197.0 | |

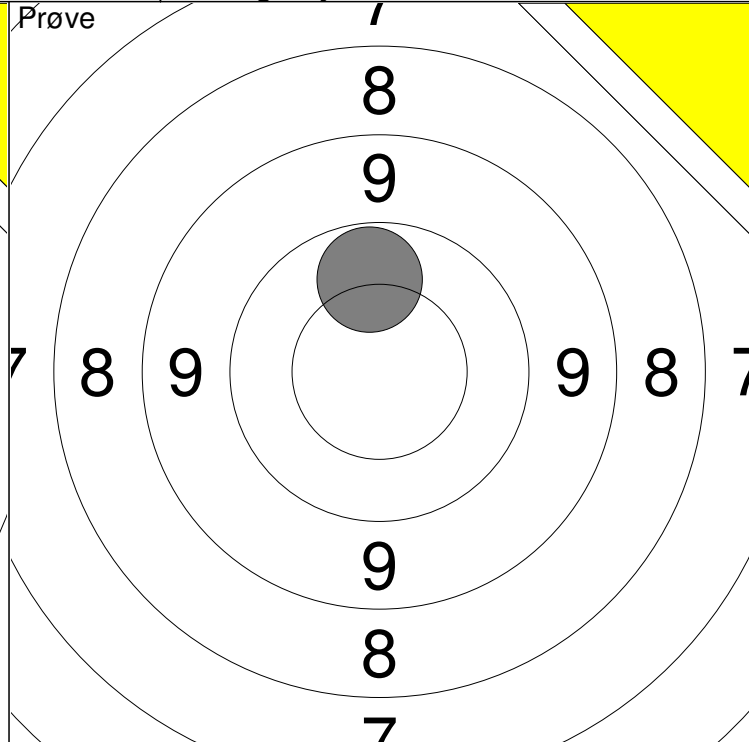
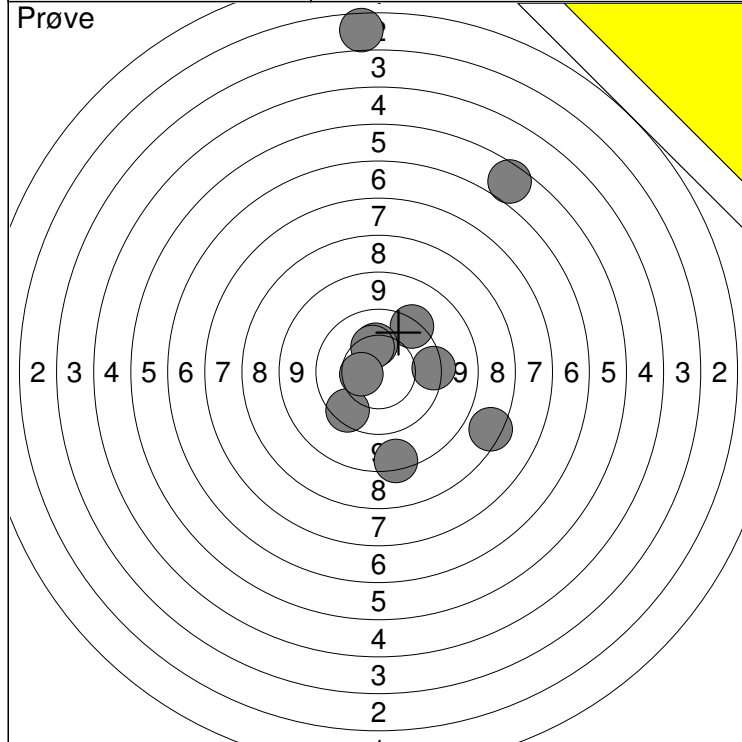

| | | |
|----------|------------|----------|
| 1: 1.8 ↑ | 6: 10.3 ↑ | Serie 77 |
| 2: 4.8 ↗ | 7: 10.3 ↑ | |
| 3: 7.6 → | 8: 9.7 ↘ | Total 0 |
| 4: 8.6 ↓ | 9: 9.5 → | |
| 5: 9.5 ↗ | 10: 10.5 ← | |

| | |
|------------|----------|
| 11: 10.0 ↑ | Serie 10 |
| | |
| | Total 0 |
| | |

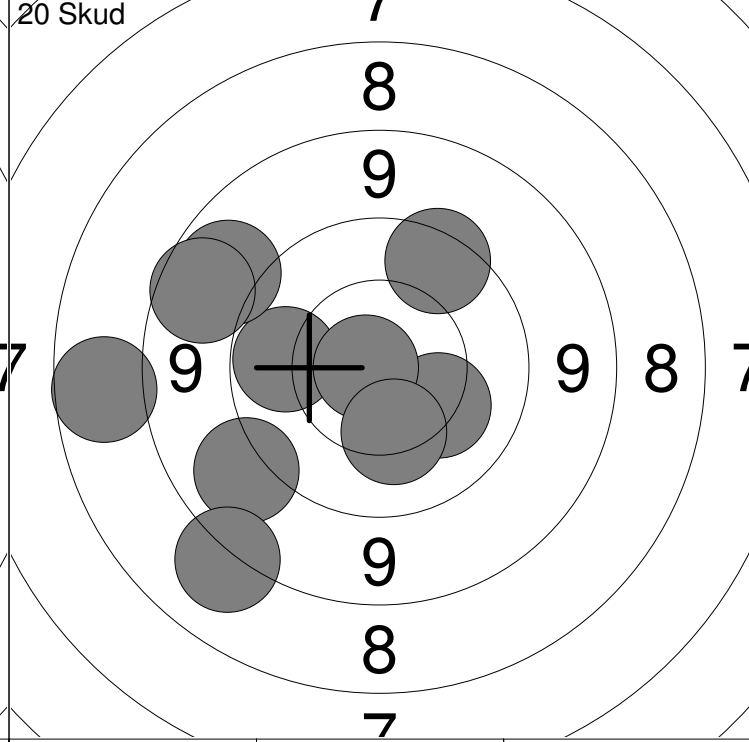
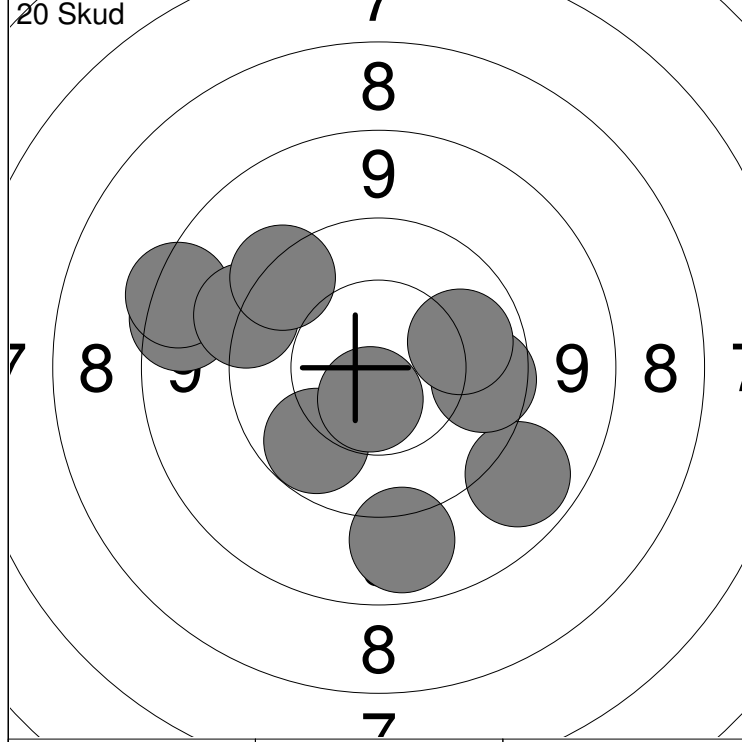

| | | |
|-----------|------------|----------|
| 1: 9.1 ↘ | 6: 9.1 ↓ | Serie 91 |
| 2: 9.9 → | 7: 8.6 ← | |
| 3: 8.7 ← | 8: 10.6x ↓ | Total 91 |
| 4: 10.1 → | 9: 9.4 ← | |
| 5: 10.0 ↙ | 10: 9.6 ↗ | |

| | | |
|------------|-------------|-----------|
| 11: 9.1 ↙ | 16: 9.7 ↗ | Serie 90 |
| 12: 10.2 ↘ | 17: 10.8x ← | |
| 13: 7.9 ← | 18: 10.3 ↓ | Total 181 |
| 14: 10.0 ← | 19: 8.9 ← | |
| 15: 9.0 ↙ | 20: 8.3 ↘ | |

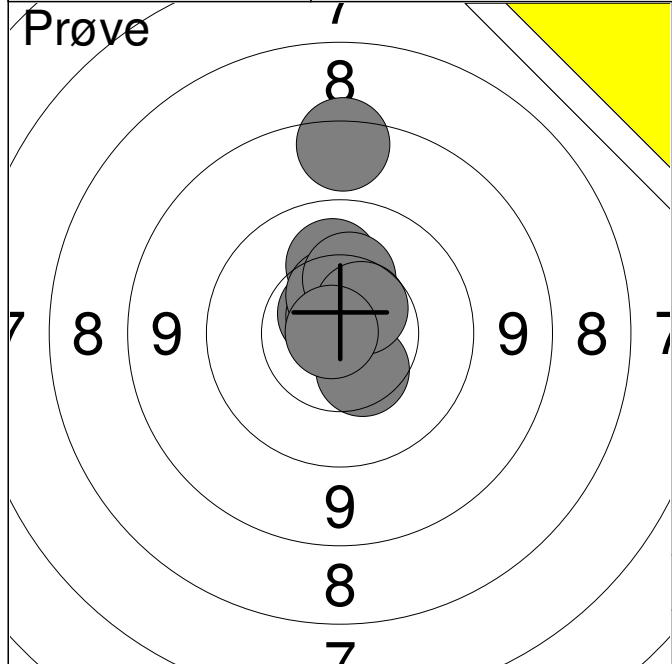

| | | |
|--------------|-------|-------------|
| 1: | 8.6 | ↑ |
| 2: | 10.2 | ↑ |
| 3: | 10.7x | ↗ |
| 4: | 10.7x | ↗ |
| 5: | 10.6x | ↑ |
| 6: | 10.5 | ↘ |
| 7: | 10.5 | ↑ |
| 8: | 10.3 | ↑ |
| 9: | 10.6 | ↗ |
| 10: | 10.8x | ← |
| Serie | | 98.0 |
| Total | | 0.0 |

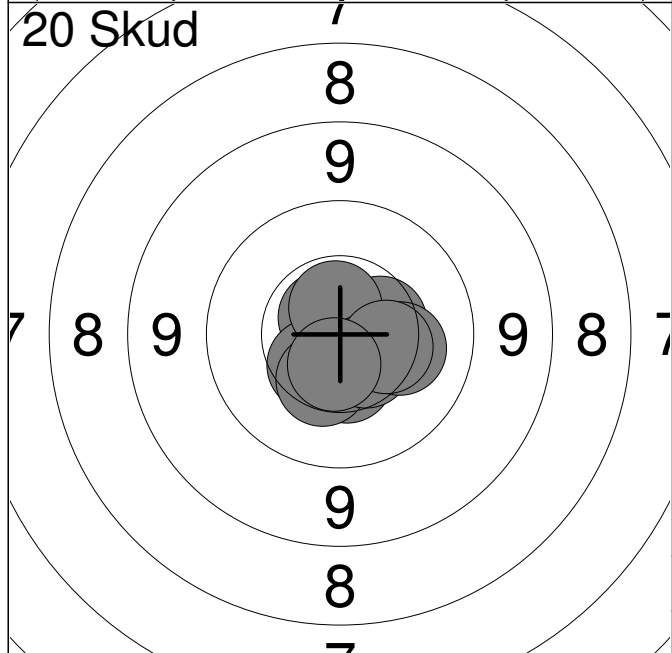

| | | |
|--------------|-------|--------------|
| 1: | 10.7x | ↗ |
| 2: | 10.5 | → |
| 3: | 10.5 | ↘ |
| 4: | 10.5 | ↙ |
| 5: | 10.6x | ↑ |
| 6: | 10.4 | ↘ |
| 7: | 10.5 | ↘ |
| 8: | 10.2 | → |
| 9: | 10.4 | → |
| 10: | 10.6x | ↘ |
| Serie | | 100.0 |
| Total | | 100.0 |

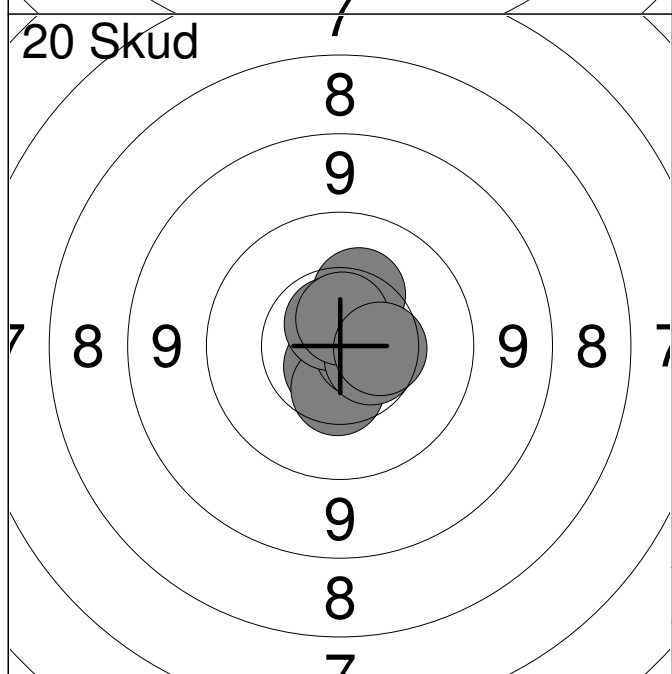

| | | |
|--------------|-------|--------------|
| 11: | 10.7x | ↘ |
| 12: | 10.7x | ↘ |
| 13: | 10.7x | ↙ |
| 14: | 10.5 | ↘ |
| 15: | 10.7x | → |
| 16: | 10.3 | ↑ |
| 17: | 10.7x | ↑ |
| 18: | 10.6 | → |
| 19: | 10.6x | ↑ |
| 20: | 10.5 | → |
| Serie | | 100.0 |
| Total | | 200.0 |

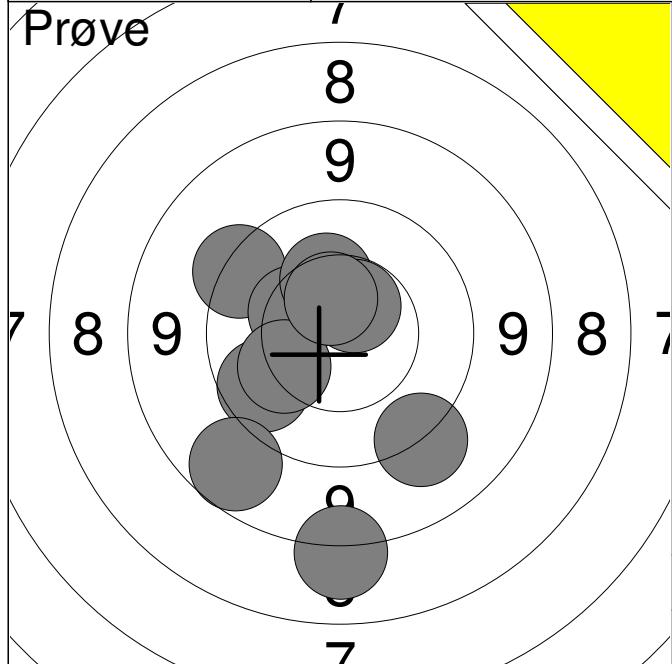

| | | |
|-----|-------|---|
| 1: | 8.3 | ↓ |
| 2: | 9.3 | ↓ |
| 3: | 9.9 | ↙ |
| 4: | 8.9 | ↙ |
| 5: | 9.6 | ↗ |
| 6: | 10.4 | ↗ |
| 7: | 10.3 | ↑ |
| 8: | 10.6x | ↑ |
| 9: | 10.2 | ↙ |
| 10: | 10.5 | ↑ |

| | |
|--------------|-------------|
| Serie | 93.0 |
| Total | 0.0 |

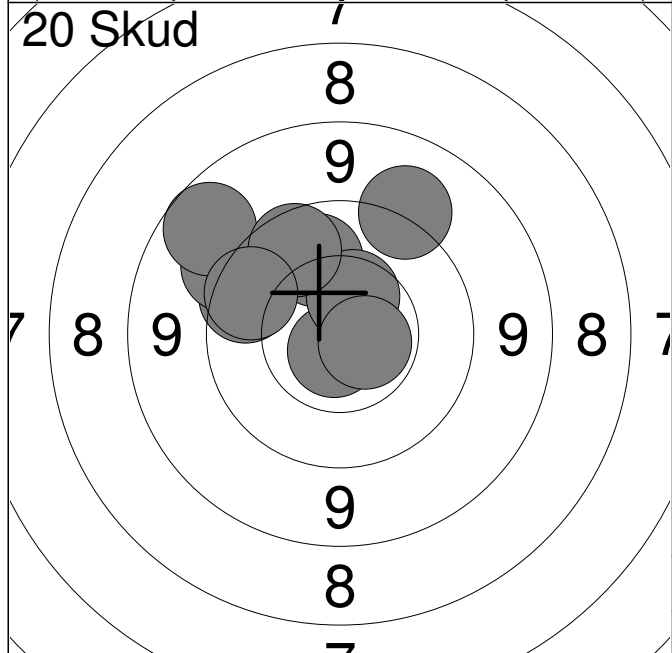

| | | |
|-----|-------|---|
| 1: | 10.1 | ↑ |
| 2: | 10.7x | ↓ |
| 3: | 9.8 | ↙ |
| 4: | 9.4 | ↗ |
| 5: | 10.5 | ↑ |
| 6: | 8.9 | ↗ |
| 7: | 9.8 | ↑ |
| 8: | 9.8 | ↗ |
| 9: | 9.3 | ↑ |
| 10: | 10.6x | → |

| | |
|--------------|-------------|
| Serie | 93.0 |
| Total | 93.0 |

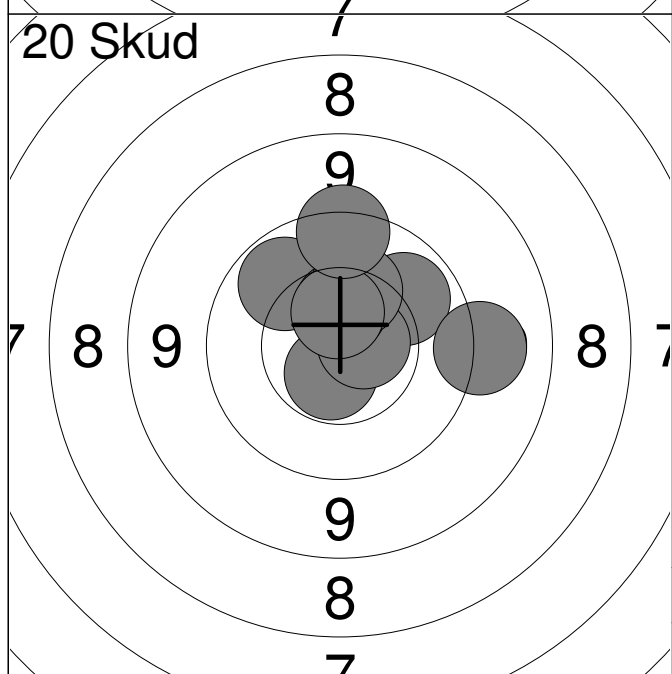

| | | |
|-----|-------|---|
| 11: | 10.7x | ↑ |
| 12: | 10.0 | ↗ |
| 13: | 9.3 | → |
| 14: | 10.0 | ↗ |
| 15: | 10.6x | ↓ |
| 16: | 10.7x | → |
| 17: | 10.5 | ↑ |
| 18: | 10.3 | ↑ |
| 19: | 10.6 | ↑ |
| 20: | 9.6 | ↑ |

| | |
|--------------|--------------|
| Serie | 98.0 |
| Total | 191.0 |

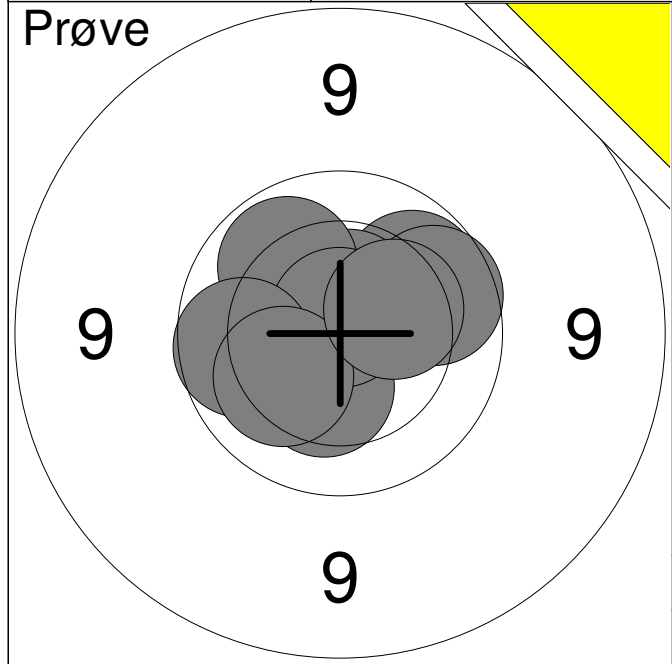

| | | |
|----|-------|---|
| 1: | 10.0 | ↗ |
| 2: | 9.9 | → |
| 3: | 10.3 | ↓ |
| 4: | 10.6x | ↑ |
| 5: | 10.0 | ↖ |
| 6: | 10.8x | ↑ |
| 7: | 9.9 | ← |
| 8: | 10.2 | ↙ |
| 9: | 10.3 | ↘ |

| | |
|--------------|-------------|
| Serie | 88.0 |
| Total | 0.0 |

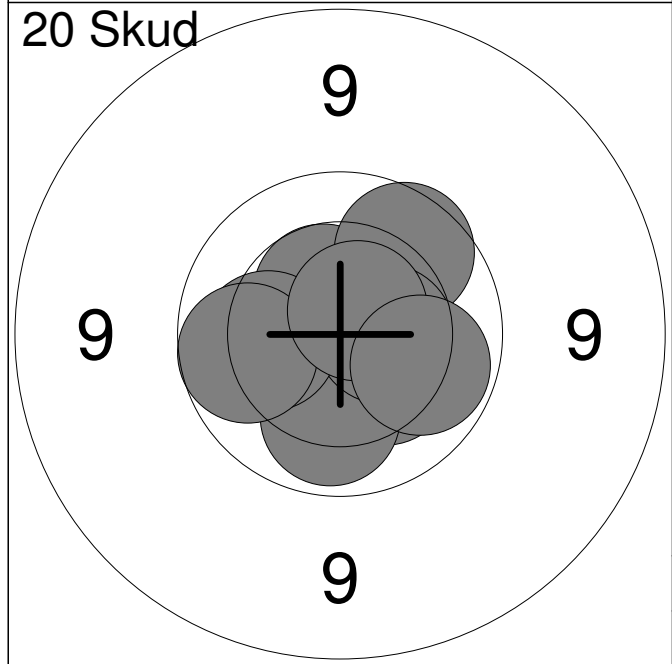

| | | |
|-----|-------|---|
| 1: | 10.5 | ↖ |
| 2: | 10.5x | ↓ |
| 3: | 9.9 | ↗ |
| 4: | 10.3 | ↘ |
| 5: | 10.1 | ↓ |
| 6: | 10.5 | → |
| 7: | 10.2 | ← |
| 8: | 9.9 | ← |
| 9: | 10.6x | ↗ |
| 10: | 10.0 | → |

| | |
|--------------|-------------|
| Serie | 98.0 |
| Total | 98.0 |

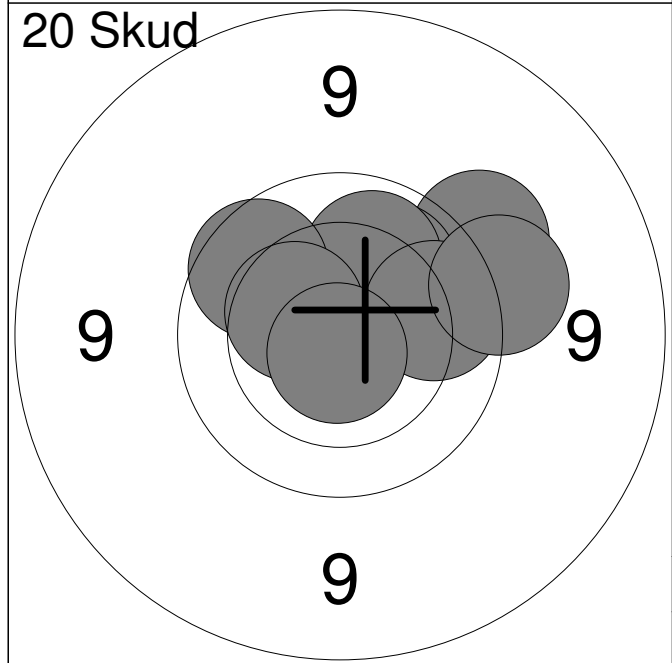

| | | |
|-----|-------|---|
| 11: | 10.4 | ↖ |
| 12: | 10.6x | ↖ |
| 13: | 9.5 | ↗ |
| 14: | 10.1 | ↗ |
| 15: | 10.1 | ↑ |
| 16: | 9.9 | ↖ |
| 17: | 9.9 | → |
| 18: | 9.5 | → |
| 19: | 10.4 | ↖ |
| 20: | 10.8x | ↓ |

| | |
|--------------|--------------|
| Serie | 96.0 |
| Total | 194.0 |

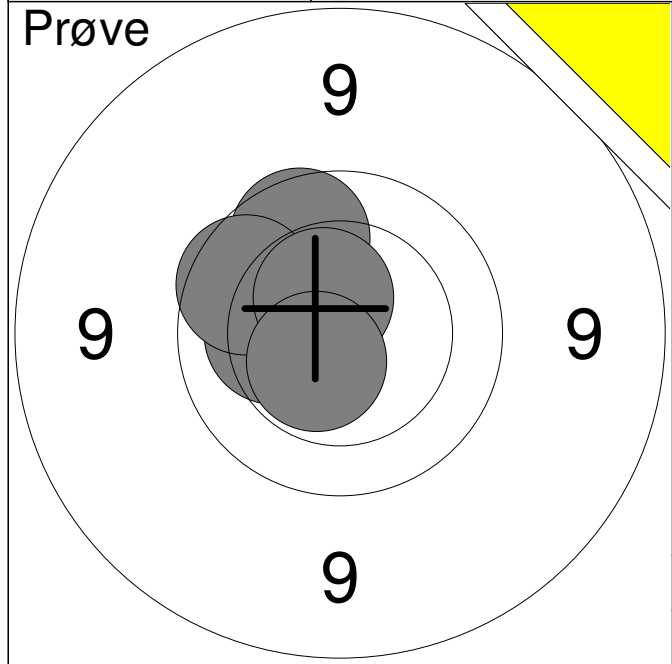

| | | |
|--------------|-------|-------------|
| 1: | 10.2 | ← |
| 2: | 9.9 | ↑ |
| 3: | 9.9 | ↑ |
| 4: | 10.5x | ↑ |
| 5: | 10.6x | ↓ |
| Serie | | 48.0 |
| Total | | 0.0 |

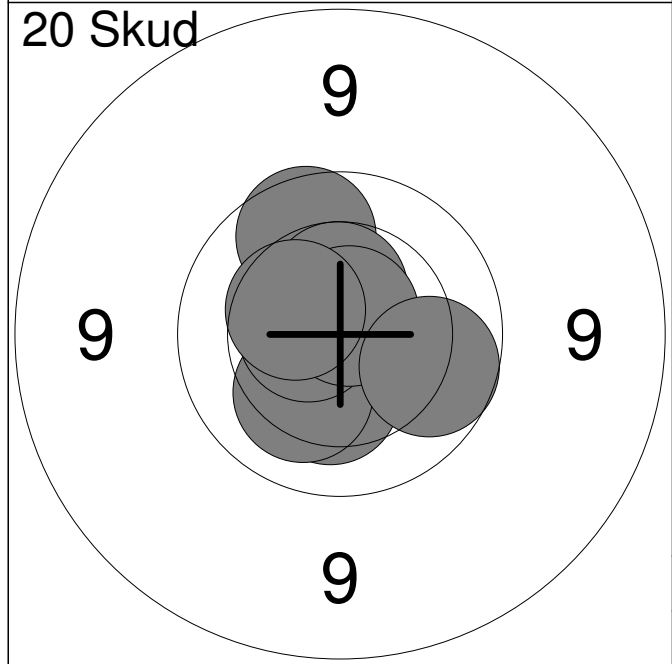

| | | |
|--------------|-------|-------------|
| 1: | 10.3 | ↓ |
| 2: | 9.9 | ↑ |
| 3: | 10.5x | ↑ |
| 4: | 10.6x | ← |
| 5: | 10.2 | ↓ |
| 6: | 10.5x | ↑ |
| 7: | 10.6x | ← |
| 8: | 10.7x | ↑ |
| 9: | 10.4 | ↑ |
| 10: | 9.9 | → |
| Serie | | 98.0 |
| Total | | 98.0 |

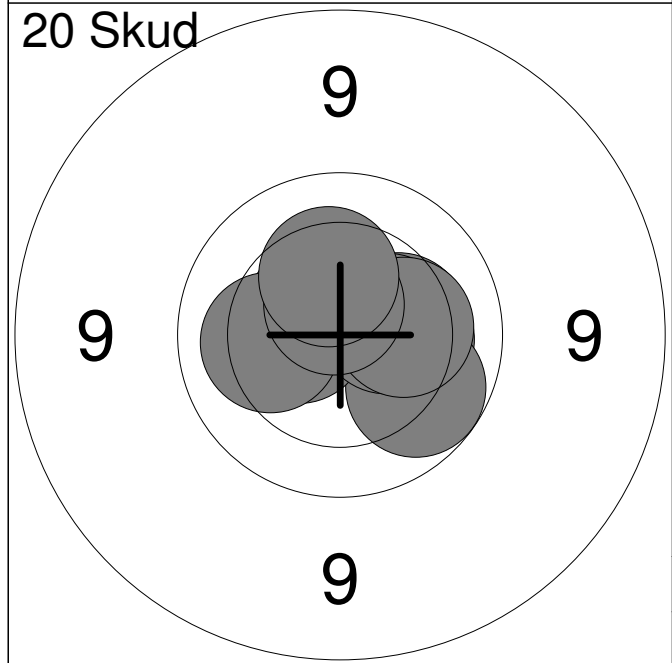

| | | |
|--------------|-------|--------------|
| 11: | 10.6x | ↑ |
| 12: | 10.3 | → |
| 13: | 10.3 | → |
| 14: | 10.0 | ↓ |
| 15: | 10.5x | ← |
| 16: | 10.2 | ← |
| 17: | 10.4 | → |
| 18: | 10.3 | → |
| 19: | 10.6x | ↑ |
| 20: | 10.3 | ↑ |
| Serie | | 100.0 |
| Total | | 198.0 |

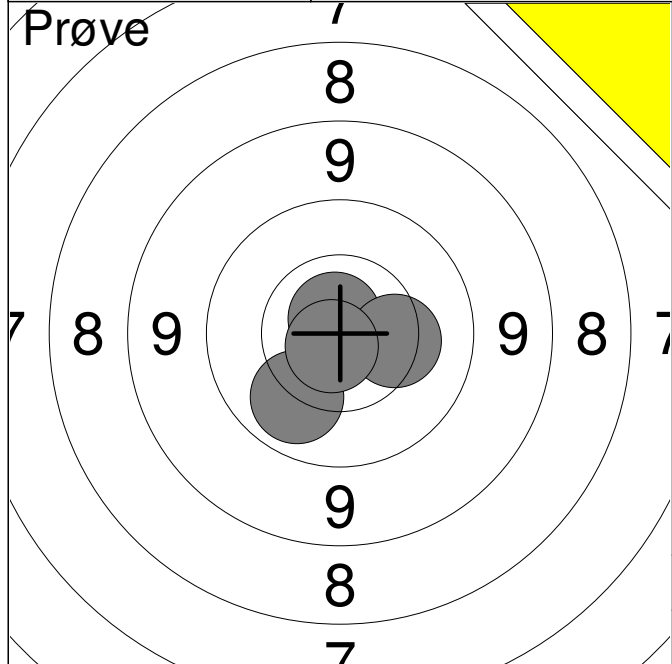

| | | |
|--------------|-------|-------------|
| 1: | 10.1 | ↙ |
| 2: | 10.8x | ↑ |
| 3: | 10.3 | → |
| 4: | 10.8x | ↘ |
| Serie | | 40.0 |
| Total | | 0.0 |

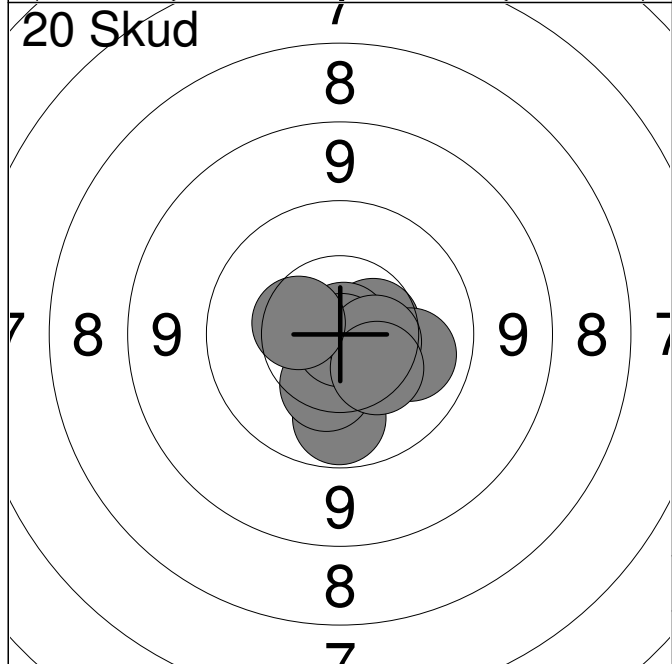

| | | |
|--------------|-------|--------------|
| 1: | 10.6 | → |
| 2: | 10.0 | ↓ |
| 3: | 10.5 | ↘ |
| 4: | 10.3 | ↘ |
| 5: | 10.1 | → |
| 6: | 10.9x | ↗ |
| 7: | 10.9x | ↓ |
| 8: | 10.5 | → |
| 9: | 10.4 | ↘ |
| 10: | 10.4 | ↖ |
| Serie | | 100.0 |
| Total | | 100.0 |

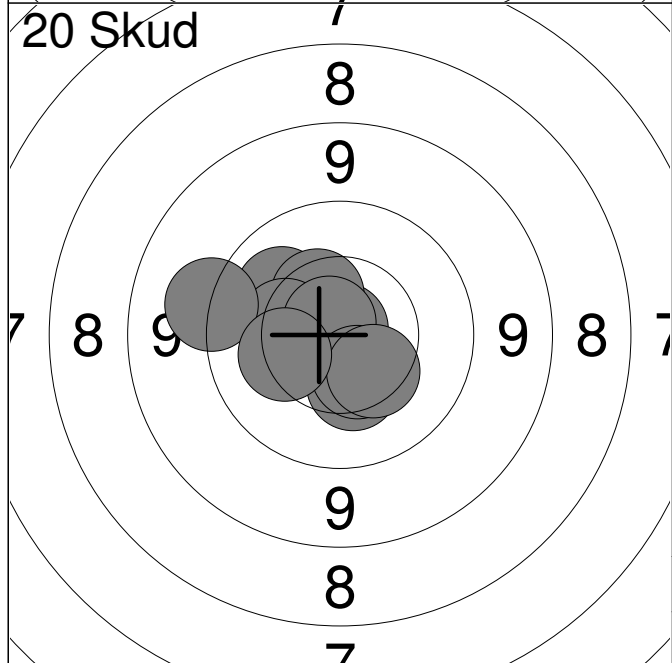

| | | |
|--------------|-------|--------------|
| 11: | 10.4 | ↓ |
| 12: | 10.9x | ↑ |
| 13: | 10.1 | ↗ |
| 14: | 10.4 | ↗ |
| 15: | 10.3 | ↖ |
| 16: | 10.8x | ↗ |
| 17: | 10.5 | ↘ |
| 18: | 10.4 | ↘ |
| 19: | 9.4 | ↖ |
| 20: | 10.3 | ↖ |
| Serie | | 99.0 |
| Total | | 199.0 |

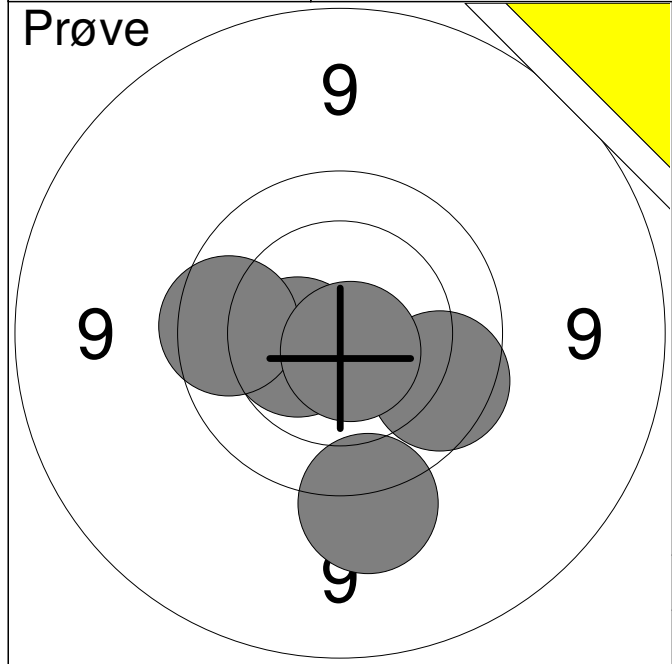

| | | |
|--------------|-------|-------------|
| 1: | 9.8 | → |
| 2: | 9.5 | ↓ |
| 3: | 10.5 | ← |
| 4: | 9.8 | ← |
| 5: | 10.7x | ↓ |
| Serie | | 47.0 |
| Total | | 0.0 |

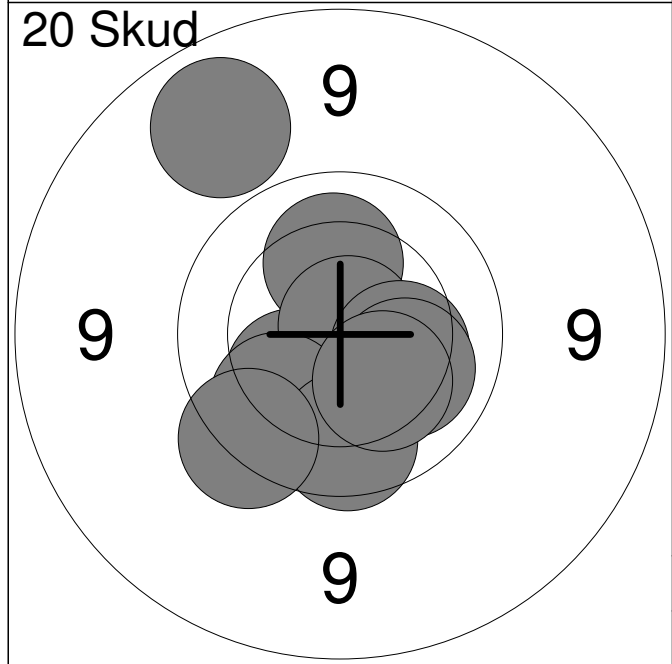

| | | |
|--------------|-------|-------------|
| 1: | 10.3 | ↙ |
| 2: | 10.2 | ↑ |
| 3: | 10.8x | ↗ |
| 4: | 10.0 | ↙ |
| 5: | 9.9 | ↓ |
| 6: | 10.3 | ↗ |
| 7: | 9.7 | ↙ |
| 8: | 10.2 | ↗ |
| 9: | 10.3 | ↙ |
| 10: | 9.1 | ↗ |
| Serie | | 97.0 |
| Total | | 97.0 |

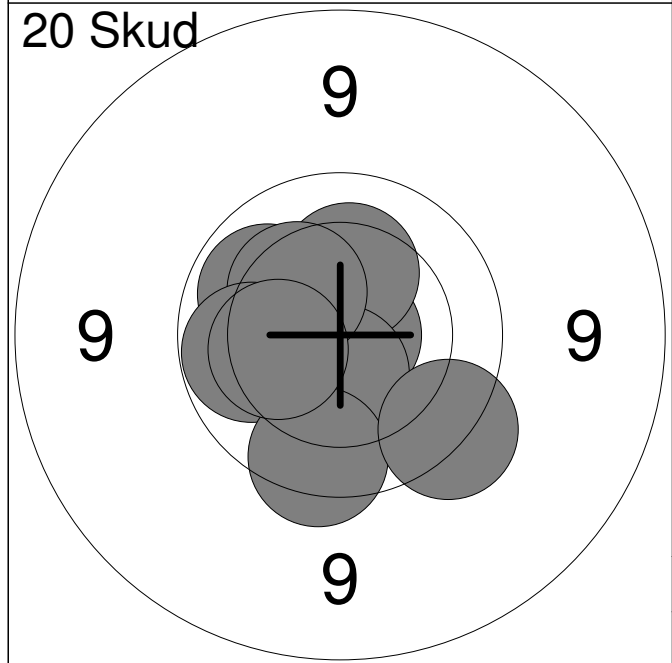

| | | |
|--------------|-------|--------------|
| 11: | 10.0 | ↗ |
| 12: | 10.8x | → |
| 13: | 10.4 | ↙ |
| 14: | 10.3 | ↑ |
| 15: | 10.5x | ↓ |
| 16: | 10.3 | ↗ |
| 17: | 10.0 | ← |
| 18: | 9.8 | ↓ |
| 19: | 10.3 | ← |
| 20: | 9.6 | ↙ |
| Serie | | 98.0 |
| Total | | 195.0 |

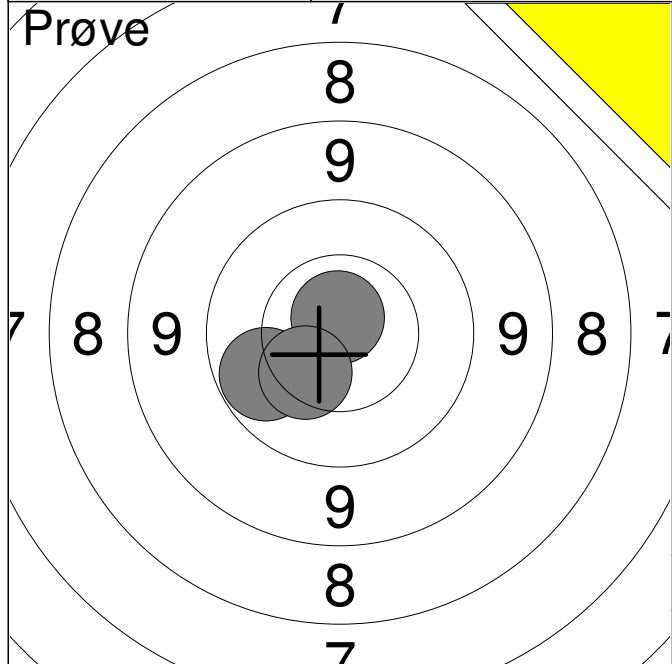

| | | |
|--------------|-------|-------------|
| 1: | 10.0 | ↙ |
| 2: | 10.8x | ↑ |
| 3: | 10.3 | ↘ |
| Serie | | 30.0 |
| Total | | 0.0 |

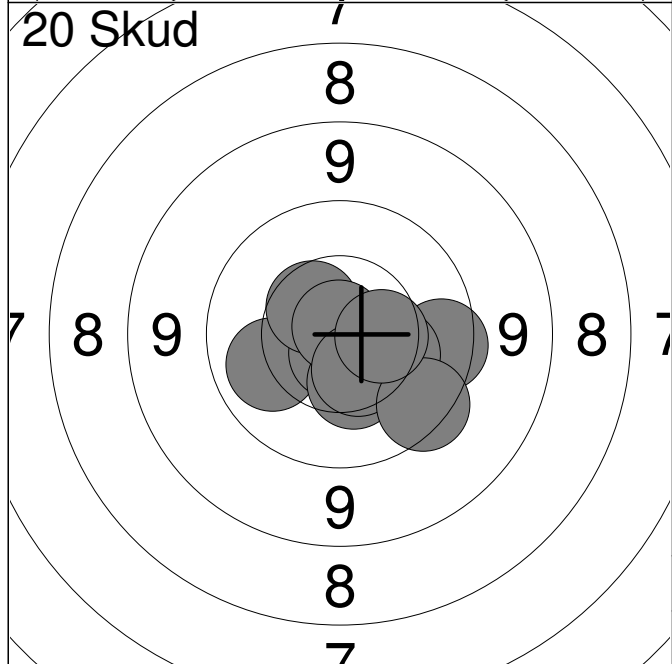

| | | |
|--------------|-------|-------------|
| 1: | 10.1 | ↙ |
| 2: | 10.7x | ↓ |
| 3: | 9.8 | → |
| 4: | 10.5 | ↗ |
| 5: | 10.4 | ↓ |
| 6: | 10.9x | ↑ |
| 7: | 10.3 | ↘ |
| 8: | 10.5 | ↓ |
| 9: | 9.7 | ↘ |
| 10: | 10.5 | → |
| Serie | | 98.0 |
| Total | | 98.0 |

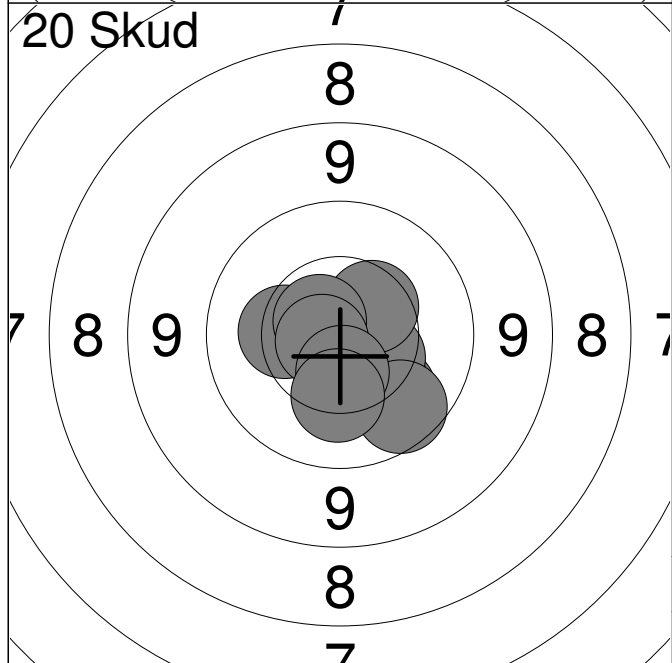

| | | |
|--------------|-------|--------------|
| 11: | 10.1 | ↘ |
| 12: | 10.2 | ↘ |
| 13: | 10.4 | ↘ |
| 14: | 10.3 | ← |
| 15: | 10.5 | ↗ |
| 16: | 9.9 | ↘ |
| 17: | 10.7x | ↗ |
| 18: | 10.7x | ← |
| 19: | 10.5 | ↓ |
| 20: | 10.2 | ↓ |
| Serie | | 99.0 |
| Total | | 197.0 |

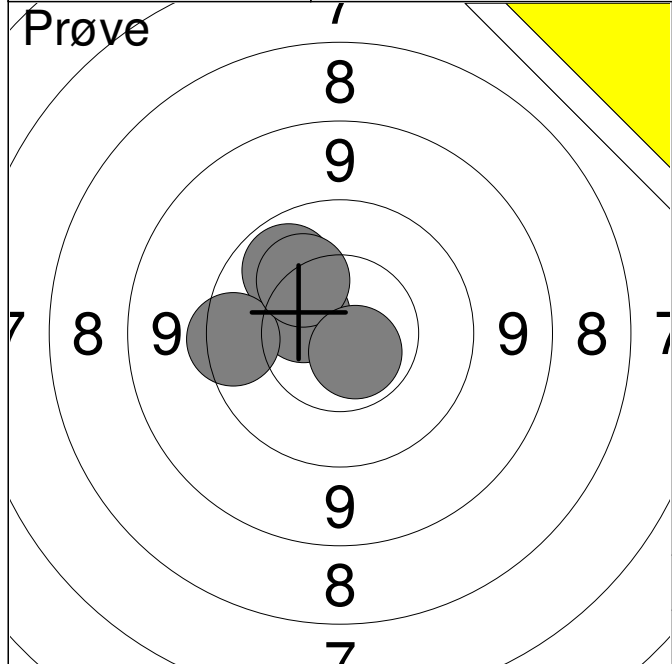

| | | |
|--------------|-------|-------------|
| 1: | 10.5 | ↗ |
| 2: | 10.0 | ↗ |
| 3: | 9.7 | ↖ |
| 4: | 10.2 | ↗ |
| 5: | 10.7x | ↘ |
| Serie | | 49.0 |
| Total | | 0.0 |

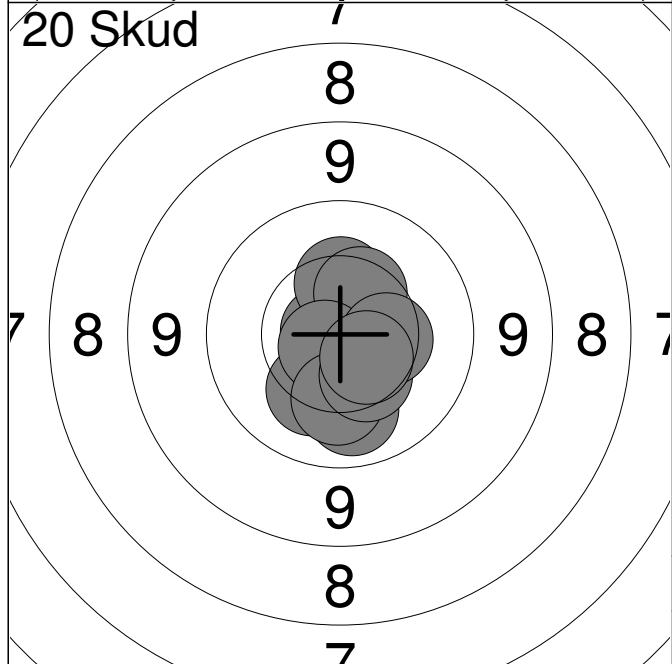

| | | |
|--------------|-------|--------------|
| 1: | 10.8x | ↖ |
| 2: | 10.4 | ↑ |
| 3: | 10.4 | ↗ |
| 4: | 10.2 | ↘ |
| 5: | 10.7x | ↖ |
| 6: | 10.1 | ↘ |
| 7: | 10.2 | ↘ |
| 8: | 10.4 | ↘ |
| 9: | 10.4 | → |
| 10: | 10.5 | ↘ |
| Serie | | 100.0 |
| Total | | 100.0 |

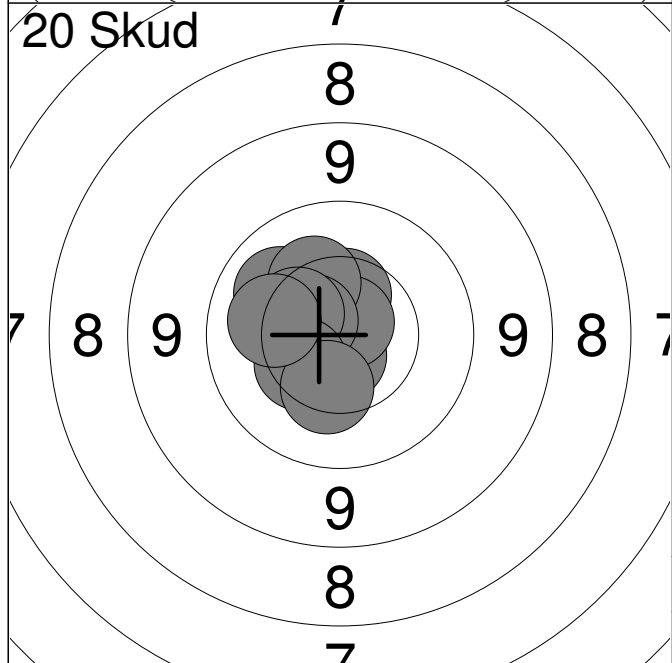

| | | |
|--------------|-------|--------------|
| 11: | 10.5 | ↑ |
| 12: | 10.7x | ↘ |
| 13: | 10.1 | ↗ |
| 14: | 10.8x | ↗ |
| 15: | 10.3 | ↗ |
| 16: | 10.6 | ↗ |
| 17: | 10.4 | ↗ |
| 18: | 10.4 | ↖ |
| 19: | 10.3 | ↘ |
| 20: | 10.2 | ↖ |
| Serie | | 100.0 |
| Total | | 200.0 |

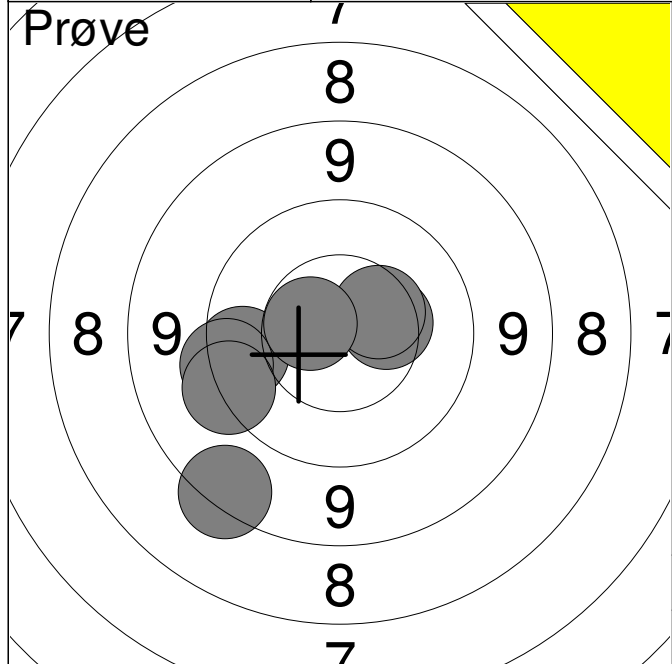

| | | |
|--------------|-------|-------------|
| 1: | 10.4 | → |
| 2: | 10.4 | ↗ |
| 3: | 9.8 | ← |
| 4: | 9.5 | ← |
| 5: | 8.6 | ↘ |
| 6: | 9.5 | ↙ |
| 7: | 10.6x | ↖ |
| Serie | | 65.0 |
| Total | | 0.0 |

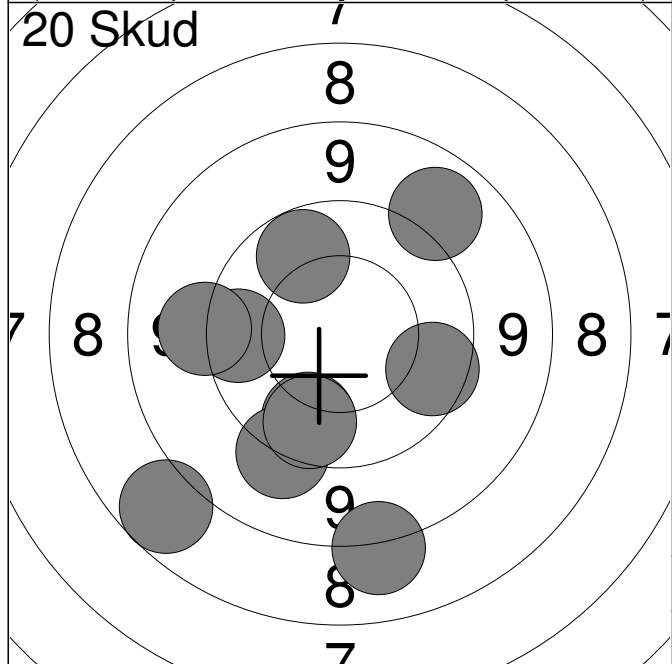

| | | |
|--------------|------|-------------|
| 1: | 7.9 | ↙ |
| 2: | 8.3 | ↓ |
| 3: | 9.7 | ← |
| 4: | 9.9 | ↘ |
| 5: | 9.4 | ↘ |
| 6: | 10.0 | ↗ |
| 7: | 9.3 | ← |
| 8: | 9.8 | → |
| 9: | 9.1 | ↗ |
| 10: | 9.9 | ↘ |
| Serie | | 88.0 |
| Total | | 88.0 |

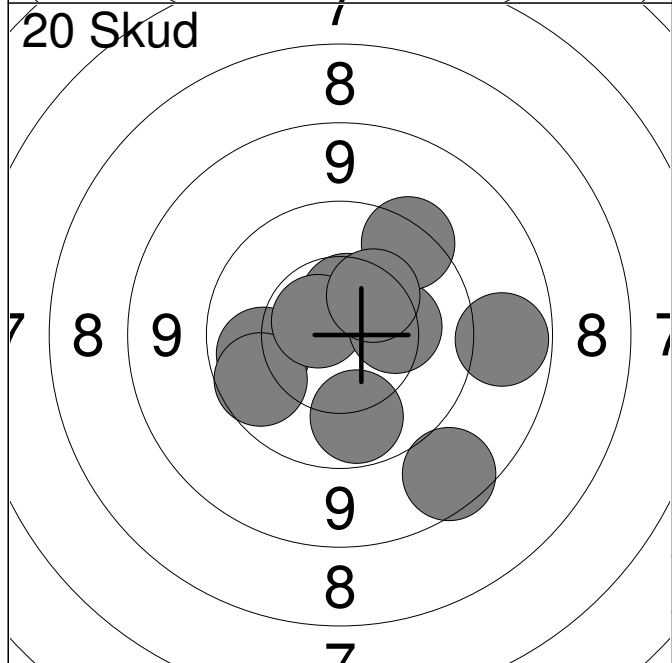

| | | |
|--------------|-------|--------------|
| 11: | 10.0 | ← |
| 12: | 9.9 | ↙ |
| 13: | 9.0 | → |
| 14: | 8.8 | ↘ |
| 15: | 10.5 | ↑ |
| 16: | 10.6x | ↗ |
| 17: | 10.3 | → |
| 18: | 10.0 | ↓ |
| 19: | 9.6 | ↗ |
| 20: | 10.4 | ↗ |
| Serie | | 95.0 |
| Total | | 183.0 |

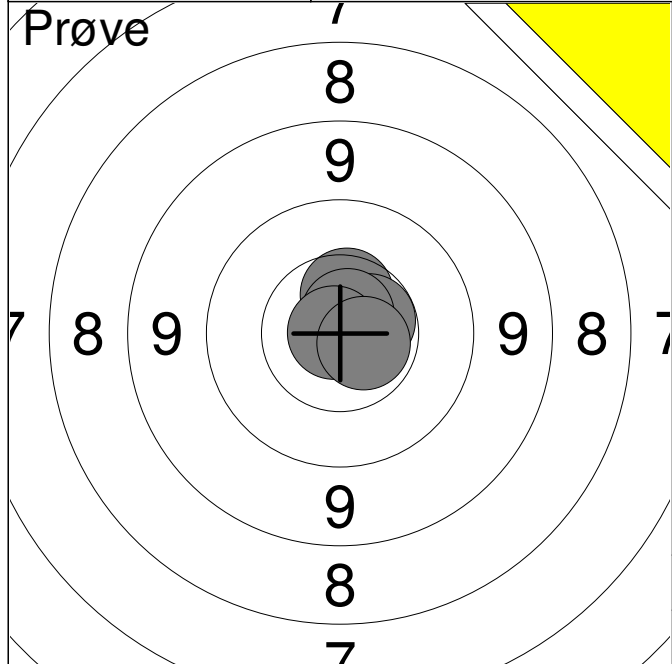

| | | |
|--------------|-------|-------------|
| 1: | 10.5 | ↑ |
| 2: | 10.6 | → |
| 3: | 10.7x | ↑ |
| 4: | 10.9x | ← |
| 5: | 10.7x | ↘ |
| Serie | | 50.0 |
| Total | | 0.0 |

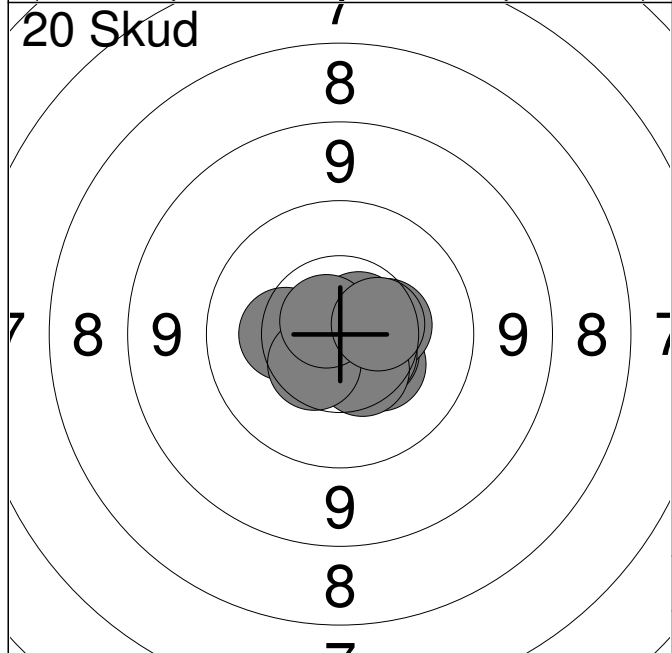

| | | |
|--------------|-------|--------------|
| 1: | 10.4 | ↘ |
| 2: | 10.5 | ↘ |
| 3: | 10.7x | ↗ |
| 4: | 10.4 | → |
| 5: | 10.5 | ↘ |
| 6: | 10.5 | ↘ |
| 7: | 10.3 | ← |
| 8: | 10.5 | ↘ |
| 9: | 10.7x | ↗ |
| 10: | 10.5 | → |
| Serie | | 100.0 |
| Total | | 100.0 |

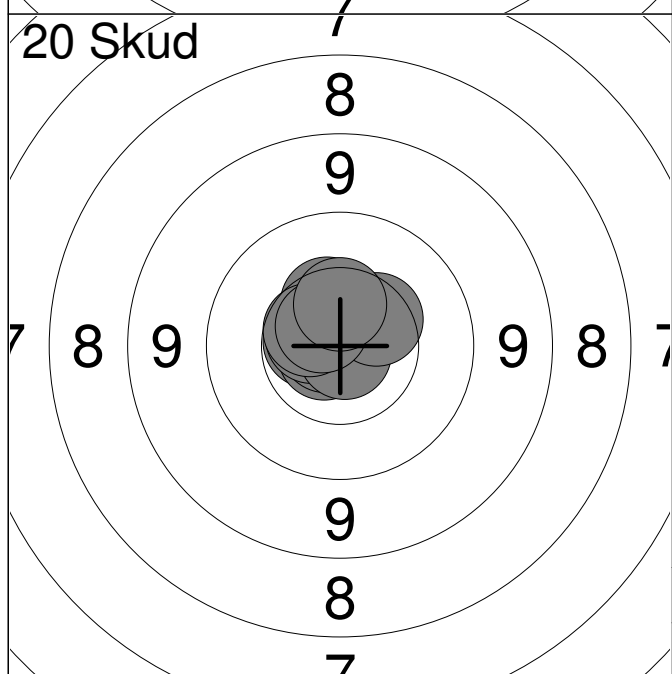

| | | |
|--------------|-------|--------------|
| 11: | 10.6x | ← |
| 12: | 10.7x | ↙ |
| 13: | 10.8x | ← |
| 14: | 10.6x | ↖ |
| 15: | 10.4 | ↗ |
| 16: | 10.9x | ↘ |
| 17: | 10.4 | ↗ |
| 18: | 10.6 | ↗ |
| 19: | 10.6x | ↗ |
| 20: | 10.5 | ↑ |
| Serie | | 100.0 |
| Total | | 200.0 |

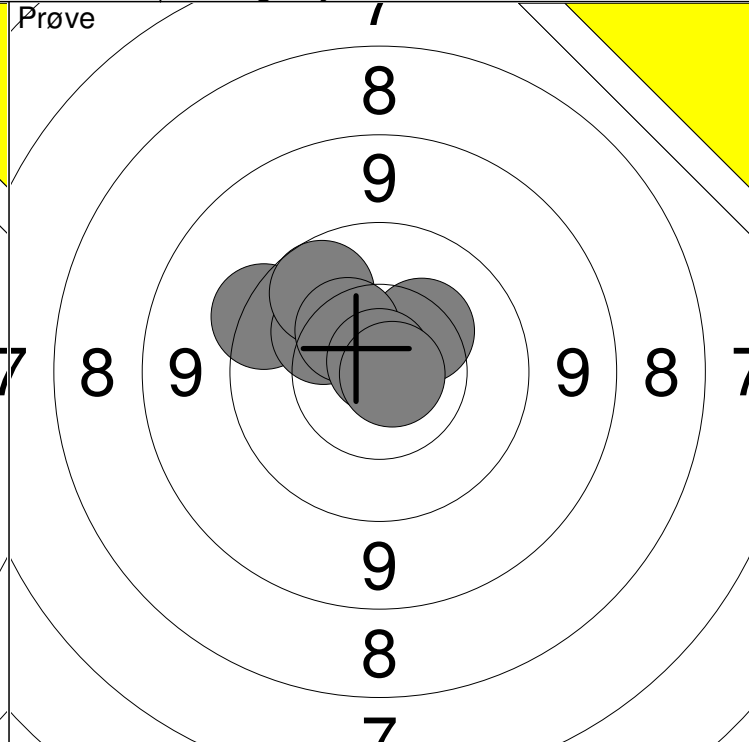
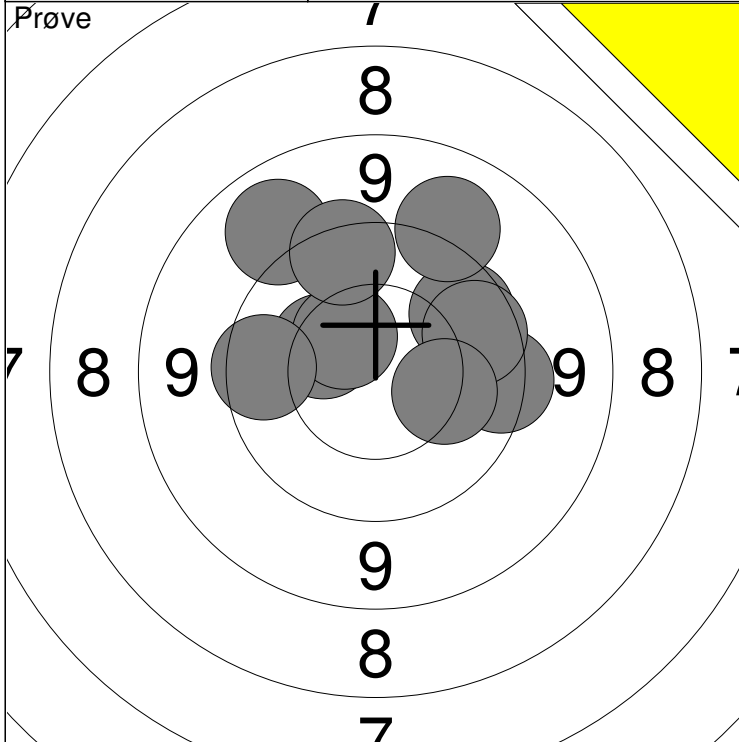

| | | | |
|-----------|-----------|-------|----|
| 1: 9.9 ↗ | 6: 10.5 ↗ | Serie | 93 |
| 2: 9.2 ↗ | 7: 10.2 → | | |
| 3: 10.3 ↖ | 8: 9.8 ← | Total | 0 |
| 4: 9.6 → | 9: 9.1 ↗ | | |
| 5: 9.8 → | 10: 9.6 ↗ | | |

| | | | |
|------------|-------------|-------|----|
| 11: 9.6 ↗ | 16: 10.8x ↑ | Serie | 68 |
| 12: 10.2 ↗ | 17: 10.8x → | | |
| 13: 9.9 ↗ | | Total | 0 |
| 14: 10.3 ↗ | | | |
| 15: 10.4 ↗ | | | |

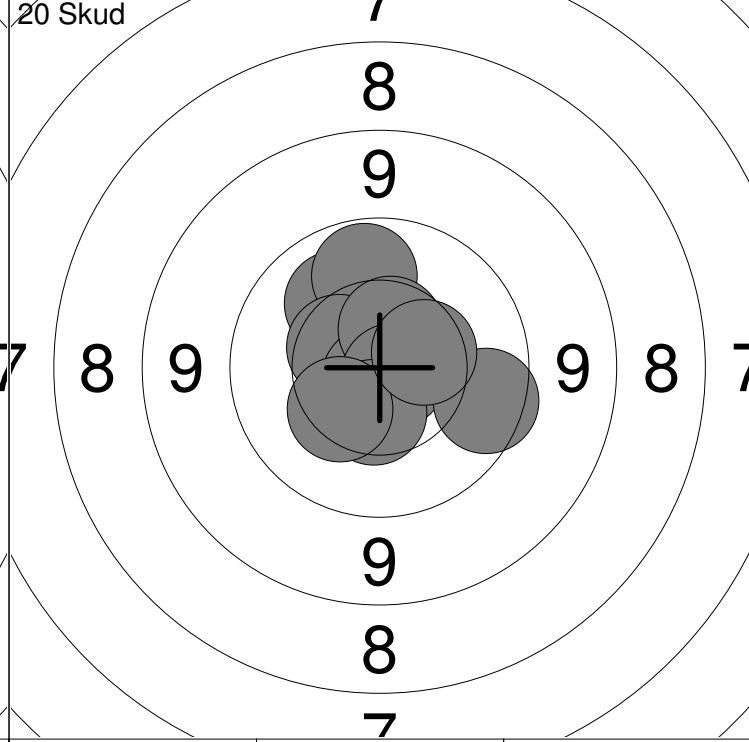
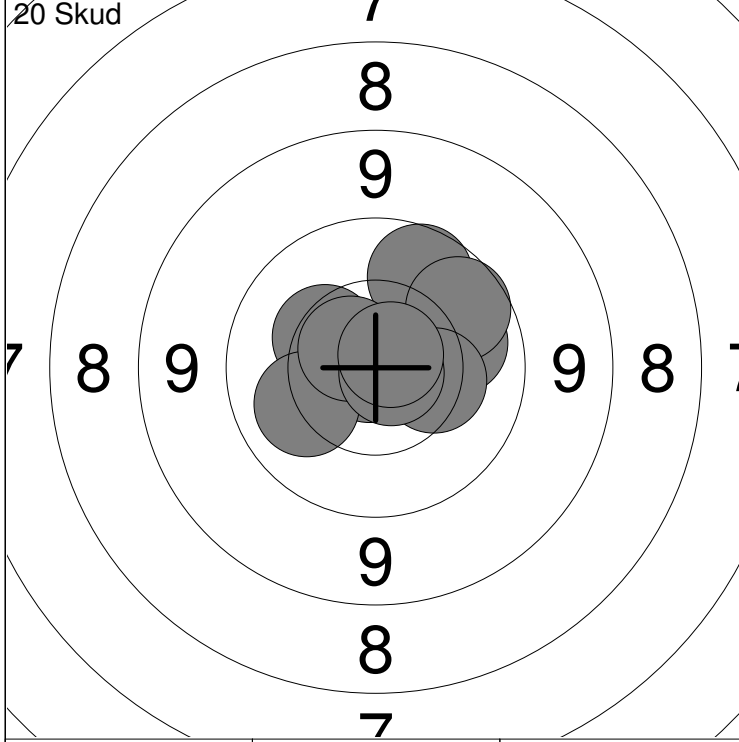

| | | | |
|-----------|-------------|-------|----|
| 1: 10.3 ↖ | 6: 10.9x ← | Serie | 98 |
| 2: 9.9 ↗ | 7: 10.1 ↖ | | |
| 3: 10.1 → | 8: 10.6x ↖ | Total | 98 |
| 4: 9.9 ↗ | 9: 10.8x → | | |
| 5: 10.3 → | 10: 10.7x ↗ | | |

| | | | |
|-------------|-------------|-------|-----|
| 11: 10.2 ↗ | 16: 10.8x ↘ | Serie | 99 |
| 12: 10.0 ↑ | 17: 9.8 → | | |
| 13: 10.5 ↖ | 18: 10.5 ↓ | Total | 197 |
| 14: 10.8x ↘ | 19: 10.4 ↘ | | |
| 15: 10.5 ↗ | 20: 10.5 → | | |